

MITSUBISHI Nch POWER MOSFET

FK10VS-9

HIGH-SPEED SWITCHING USE

FK10VS-9



- V_{DSS} 450V
- r_{DS} (ON) (MAX) 0.92Ω
- I_D 10A
- Integrated Fast Recovery Diode (MAX.) 150ns

OUTLINE DRAWING

Dimensions in mm

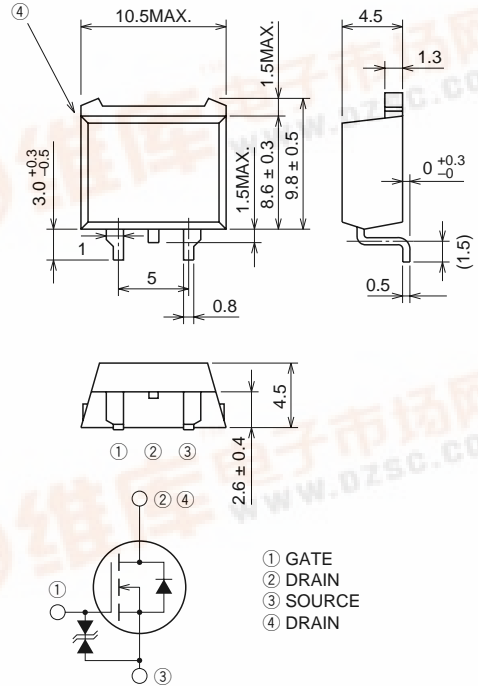

TO-220S

APPLICATION

Servo motor drive, Robot, UPS, Inverter Fluorecent lamp, etc.

MAXIMUM RATINGS (T_c = 25°C)

Symbol	Parameter	Conditions	Ratings	Unit
V _{DSS}	Drain-source voltage	V _{GS} = 0V	450	V
V _{GSS}	Gate-source voltage	V _{DS} = 0V	±30	V
I _D	Drain current		10	A
I _{DM}	Drain current (Pulsed)		30	A
I _S	Source current		10	A
I _{SM}	Source current (Pulsed)		30	A
P _D	Maximum power dissipation		125	W
T _{ch}	Channel temperature		-55 ~ +150	°C
T _{stg}	Storage temperature		-55 ~ +150	°C
—	Weight	Typical value	1.2	g

FK10VS-9

HIGH-SPEED SWITCHING USE

ELECTRICAL CHARACTERISTICS (Tch = 25°C)

Symbol	Parameter	Test conditions	Limits			Unit
			Min.	Typ.	Max.	
V(BR)DSS	Drain-source breakdown voltage	Id = 1mA, VGS = 0V	450	—	—	V
V(BR)GSS	Gate-source breakdown voltage	Ig = ±100μA, VDS = 0V	±30	—	—	V
IGSS	Gate-source leakage current	VGS = ±25V, VDS = 0V	—	—	±10	μA
IDSS	Drain-source leakage current	VDS = 450V, VGS = 0V	—	—	1	mA
VGS(th)	Gate-source threshold voltage	Id = 1mA, VDS = 10V	2	3	4	V
rDS(ON)	Drain-source on-state resistance	Id = 5A, VGS = 10V	—	0.70	0.92	Ω
VDS(ON)	Drain-source on-state voltage	Id = 5A, VGS = 10V	—	3.50	4.60	V
yfs	Forward transfer admittance	Id = 5A, VDS = 10V	3.3	5.5	—	S
Ciss	Input capacitance	VDS = 25V, VGS = 0V, f = 1MHz	—	1100	—	pF
Coss	Output capacitance		—	130	—	pF
Crss	Reverse transfer capacitance		—	20	—	pF
td(on)	Turn-on delay time	VDD = 200V, Id = 5A, VGS = 10V, RGEN = RGS = 50Ω	—	20	—	ns
tr	Rise time		—	30	—	ns
td(off)	Turn-off delay time		—	95	—	ns
tf	Fall time		—	35	—	ns
VSD	Source-drain voltage	Is = 5A, VGS = 0V	—	1.5	2.0	V
Rth(ch-c)	Thermal resistance	Channel to case	—	—	1.0	°C/W
trr	Reverse recovery time	Is = 10A, dis/dt = -100A/μs	—	—	150	ns

PERFORMANCE CURVES

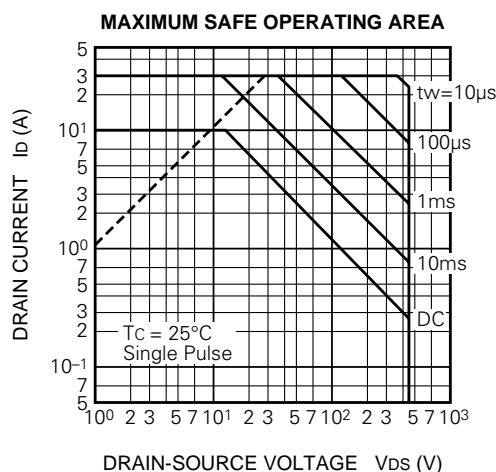
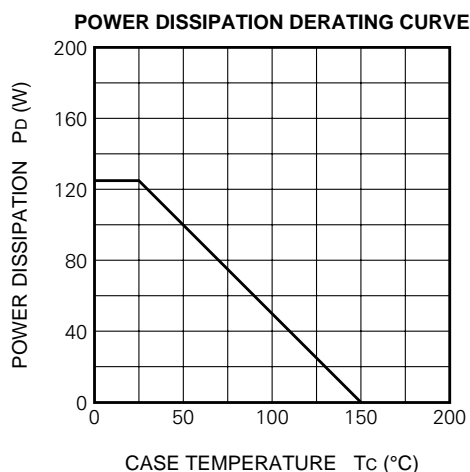

FK10VS-9

HIGH-SPEED SWITCHING USE

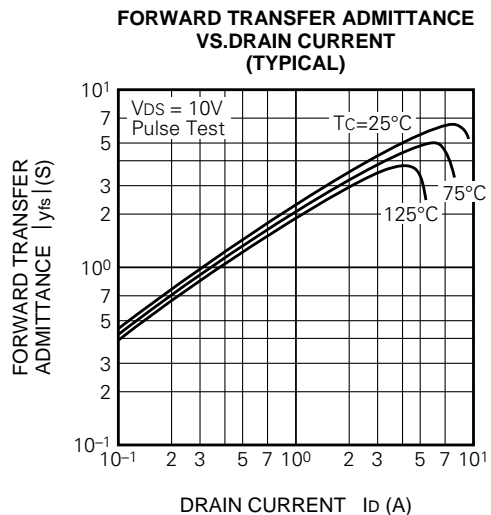
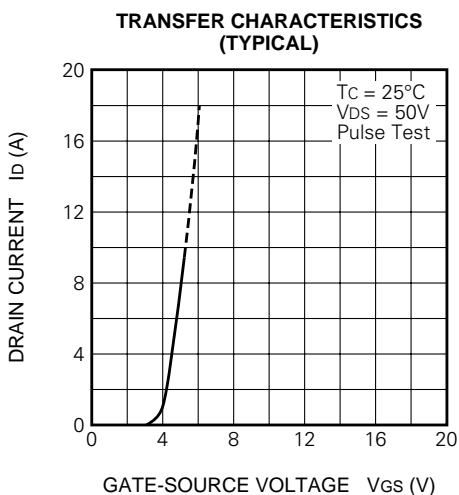
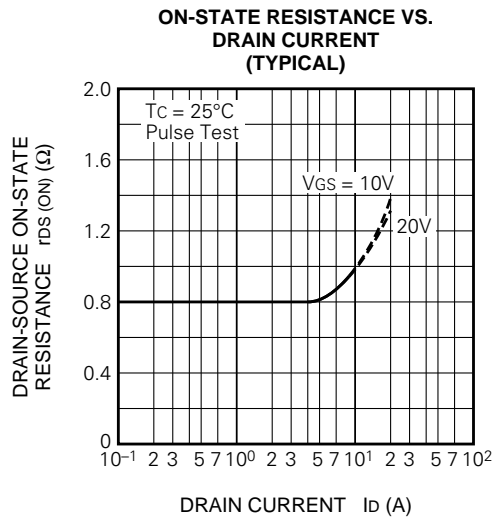
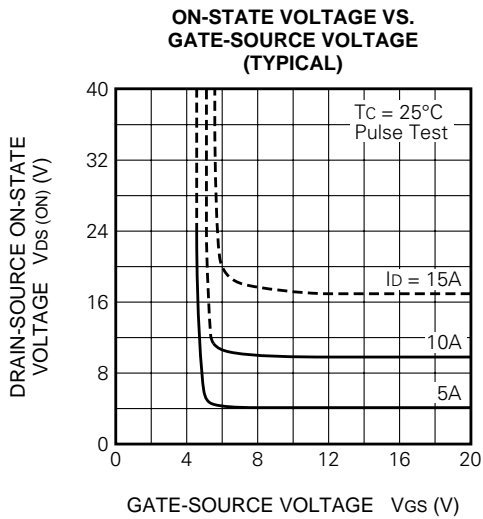
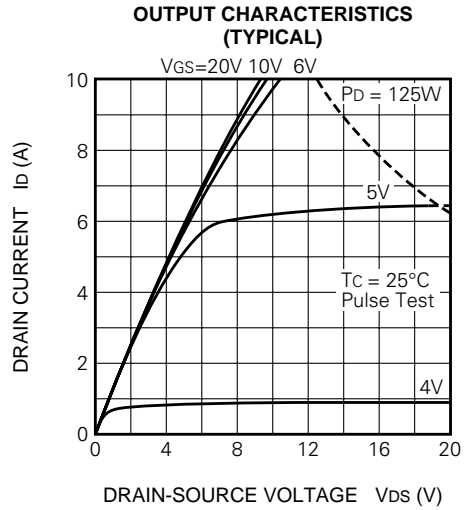
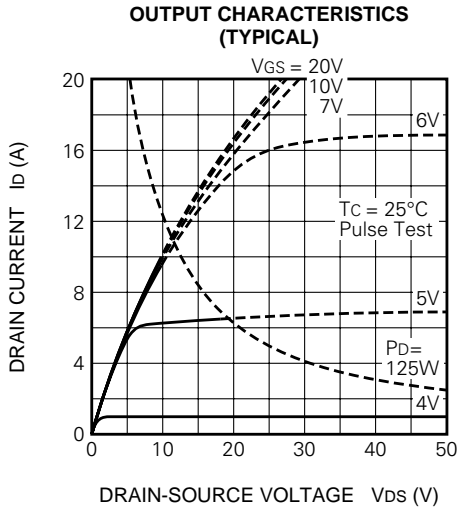

FK10VS-9

HIGH-SPEED SWITCHING USE

CAPACITANCE VS. DRAIN-SOURCE VOLTAGE (TYPICAL)

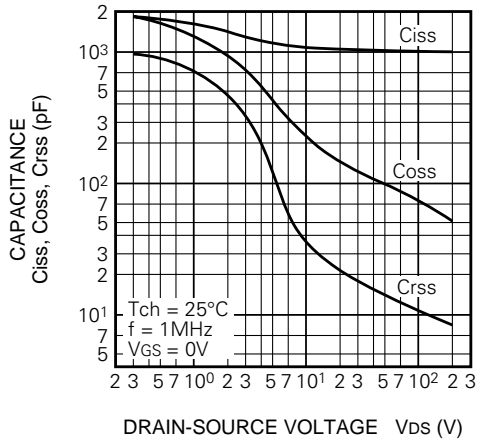

SWITCHING CHARACTERISTICS (TYPICAL)

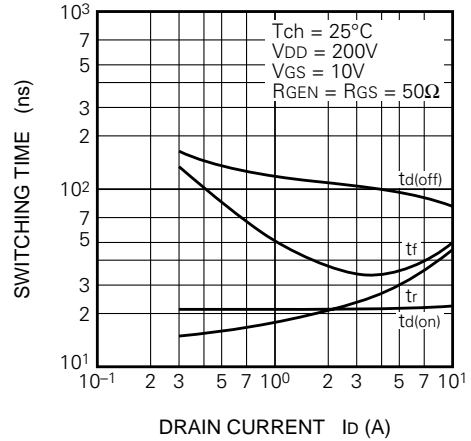

GATE-SOURCE VOLTAGE VS. GATE CHARGE (TYPICAL)

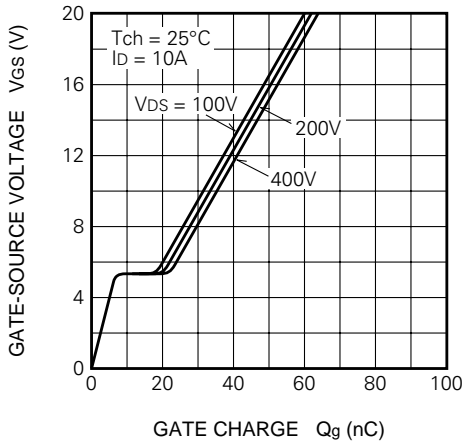

SOURCE-DRAIN DIODE FORWARD CHARACTERISTICS (TYPICAL)

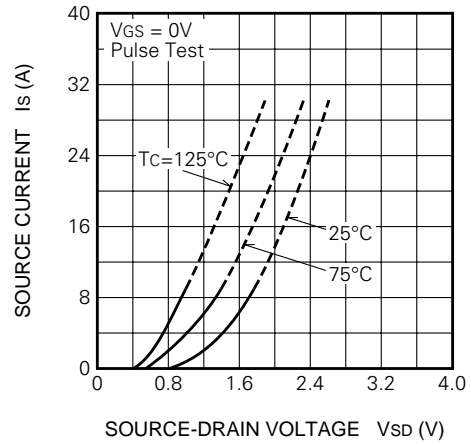

ON-STATE RESISTANCE VS. CHANNEL TEMPERATURE (TYPICAL)

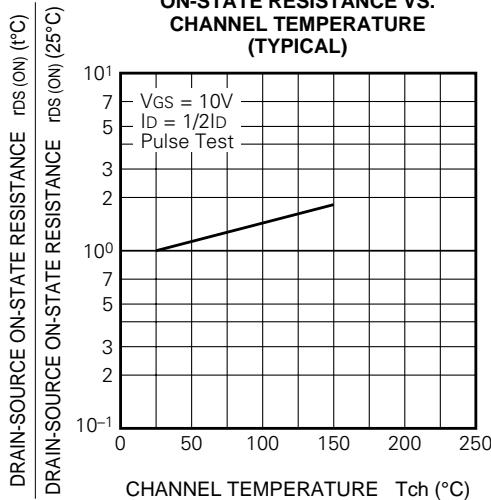

THRESHOLD VOLTAGE VS. CHANNEL TEMPERATURE (TYPICAL)

