

[查询IRFK6JC50供应商](#)

[捷多邦, 专业PCB打样工厂](#)
[, 24小时加急出货](#)

Bulletin E27114

International Rectifier IRFK6HC50, IRFK6JC50

Isolated Base Power HEX-pak™ Assembly - Parallel Chip Configuration

- High Current Capability.
- UL recognised E78996.
- Electrically Isolated Base Plate.
- Easy Assembly into Equipment.

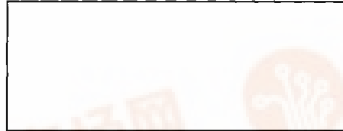

Description

The HEX-pak™ utilises the well-proven HEXFET™ die, combining low on-state resistance with high transconductance. These superior technology die are assembled by state of the art techniques into the TO-240 package, featuring 2.5kV rms isolation and solid M5 screw connections. The small footprint means the package is highly suited to power applications where space is a premium. Available in two versions, IRFK.H... for fast switching and IRFK.J... for oscillation sensitive applications.

$$V_{DS} = 600V$$
$$R_{DS(on)} = 100m\Omega$$
$$I_D = 48A$$

Absolute Maximum Rating

	Parameter	Max.	Units
I_D @ $T_C=25^\circ C$	Continuous Drain Current	48	A
I_D @ $T_C=100^\circ C$	Continuous Drain Current	30	A
I_{DM}	Pulse Drain Current	192	A ①
P_D @ $T_C=25^\circ C$	Maximum Power Dissipation	625	W
V_{GS}	Gate-to-Source Voltage	20	V
V_{INS}	R.M.S. Isolation Voltage, circuit to base	2.5	kV
T_J	Operating Junction Temperature Range	-40 to 150	$^\circ C$
T_{STG}	Storage Temperature Range	-40 to 150	$^\circ C$

Thermal and Mechanical Specifications

	Parameter	Min.	Typ.	Max.	Units
R_{thJC}	Junction-to-Case	-	-	0.20	K/W ②
R_{thCS}	Case-to-Sink, smooth & greased surface	-	0.1	-	K/W
T	Mounting Torque +10%				③
	HEXpak to Heatsink	-	5	-	Nm
	Busbar to HEXpak	-	3	-	Nm
wt	Approximate Weight	-	140	-	g
		-	5	-	oz

Notes:

① - Repetitive Rating: Pulse width limited by maximum junction temperature see figure 8.

② - Per Module.

③ - A mounting compound is recommended and the torque should be rechecked after a period of three hours to allow for the spread of the compound.



找PDF
pdf.dzsc.com

IRFK6HC50, IRFK6JC50



Electrical Characteristics @ $T_J = 25^\circ\text{C}$ (Unless otherwise specified)

	Parameter	Min.	Typ.	Max.	Units	Test Conditions	
B_{VDSS}	Drain-to-Source Breakdown voltage	600	-	-	V	$V_{GS}=0V, I_D=1.0mA$	
$R_{DS(on)}$	Static Drain-to-Source On-State Resistance	-	80	100	m Ω	$V_{GS}=10V, I_D=30A$	
$I_{D(on)}$	On-State Drain Current	48	-	-	A	$V_{DS} > I_{D(on)} \times R_{DS(on)}$ max, $V_{GS}=10V$	
$V_{GS(th)}$	Gate Threshold Voltage	2.0	-	4.0	V	$V_{DS}=V_{GS}, I_D=1.5mA$	
g_{fs}	Forward Transconductance ④	35	53	-	S	$V_{DS} > 50V, I_D=30A$	
I_{DSS}	Zero Gate Voltage Drain Current	-	-	1.5	mA	$V_{DS}=V_{DS}max, V_{GS}=0V$	
		-	-	6.0	mA	$V_{GS}=10V, T_C=125^\circ\text{C}, V_{DS}=V_{DS}max \times 0.8$	
I_{GSS}	Gate-to-Source Leakage Forward	-	-	600	nA	$V_{GS}=20V$	
I_{GSS}	Gate-to-Source Leakage Reverse	-	-	-600	nA	$V_{GS}=-20V$	
Q_g	Total Gate Charge	-	720	780	nC	$I_D=48A, V_{GS}=10V,$	
Q_{gs}	Gate-to-Source Charge	-	75	120	nC	$V_{DS}=V_{DS}max \times 0.8$	
Q_{gd}	Gate-to-Drain ("Miller") Charge	-	250	360	nC		
$t_{d(on)}$	Turn-on Delay Time	IRFK6HC50	-	80	-	ns	$V_{DD}=300V, I_D=30A,$ $V_{GS}=10V,$
		IRFK6JC50	-	90	-	ns	
t_r	Rise Time	IRFK6HC50	-	60	-	ns	$R_{SOURCE}=3.3\Omega$
		IRFK6JC50	-	75	-	ns	
$t_{d(off)}$	Turn-off Delay Time	IRFK6HC50	-	400	-	ns	$R_{SOURCE}=3.3\Omega$
		IRFK6JC50	-	550	-	ns	
t_f	Fall Time	IRFK6HC50	-	70	-	ns	$R_{SOURCE}=3.3\Omega$
		IRFK6JC50	-	110	-	ns	
L_{DS}	Drain-to-Source Inductance	-	18	-	nH		
C_{iss}	Input Capacitance	-	14.0	-	nF	$V_{GS}=0V, V_{DS}=25V,$	
C_{oss}	Output Capacitance	-	2.2	-	nF	$f=1.0MHz$	
C_{riss}	Reverse Transfer Capacitance	-	1.0	-	nF		
	Linear Derating Factor	-	-	5	W/K		

Source-Drain Diode Ratings and Characteristics

	Parameter	Min.	Typ.	Max.	Units	Test Conditions
I_S	Continuous Source Current (Body Diode)	-	-	48	A	
I_{SM}	Pulsed Source Current (Body Diode)	-	-	165	A	
V_{SD}	Diode Forward Voltage	-	-	1.8	V	$V_{GS}=0V, I_S=48A, T_C=25^\circ\text{C}$
t_{rr}	Reverse Recovery Time	370	770	1600	ns	$di/dt=400A/\mu s, T_J=150^\circ\text{C}$
Q_{rr}	Reverse Recovered Charge	19.0	38.0	78.0	μC	$I_S=48A$

Notes:

④ - Pulse Width $\leq 300\mu s$; Duty cycle $\leq 2\%$.



IRFK6HC50, IRFK6JC50

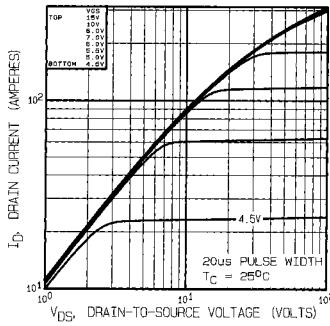

Fig 1. Typical Output Characteristics,
 $T_C = 25^\circ\text{C}$

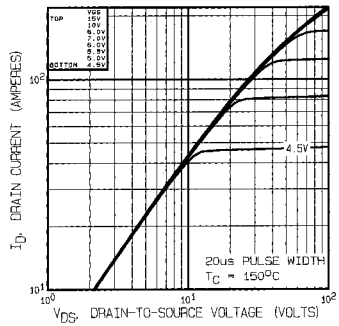

Fig 2. Typical Output Characteristics,
 $T_C = 150^\circ\text{C}$

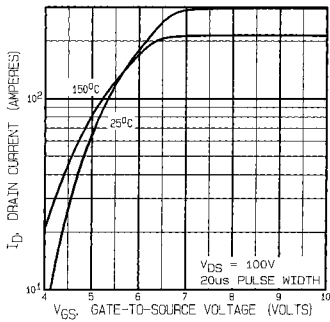

Fig 3. Typical Transfer Characteristics

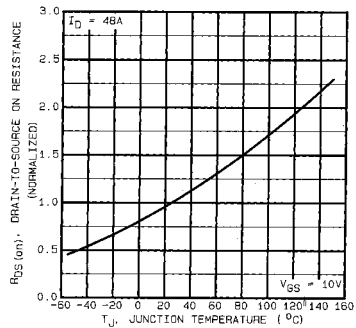

Fig 4. Normalized On-Resistance Vs. Temperature

IRFK6HC50, IRFK6JC50

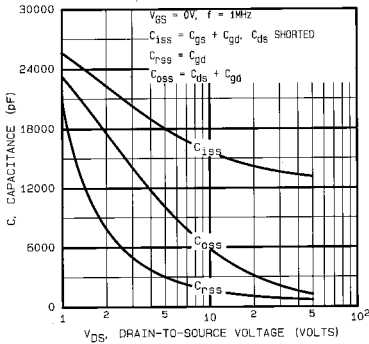

Fig 5. Typical Capacitance Vs. Drain-to-Source Voltage

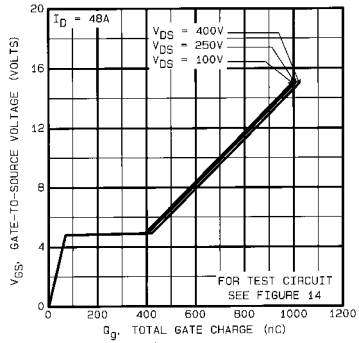

Fig 6. Typical Gate Charge Vs. Gate-to-Source Voltage

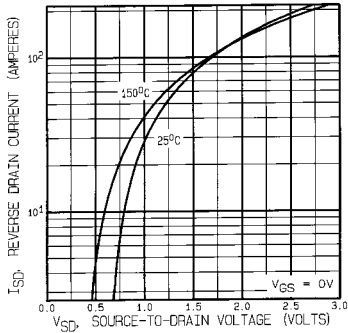

Fig 7. Typical Source-Drain Diode Forward Voltage

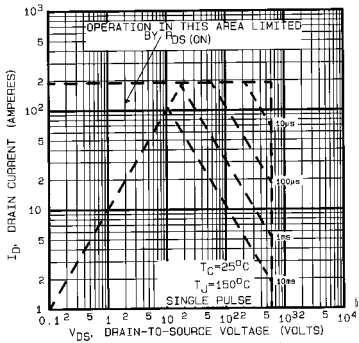

Fig 8. Maximum Safe Operating Area



IRFK6HC50, IRFK6JC50

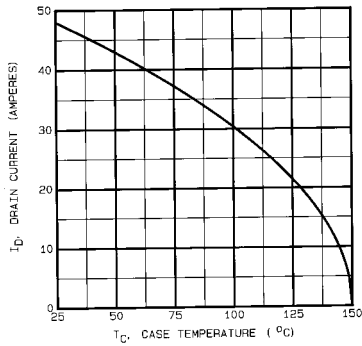

Fig 9. Maximum Drain Current Vs. Case Temperature

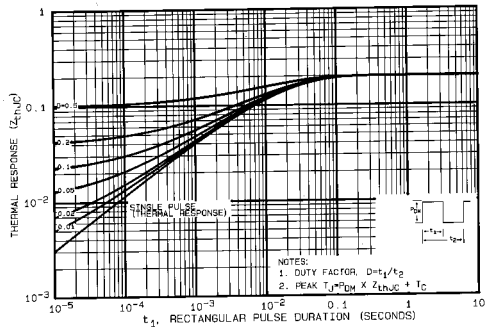

Fig 10. Maximum Effective Transient Thermal Impedance, Junction-to-Case

IRFK6HC50, IRFK6JC50

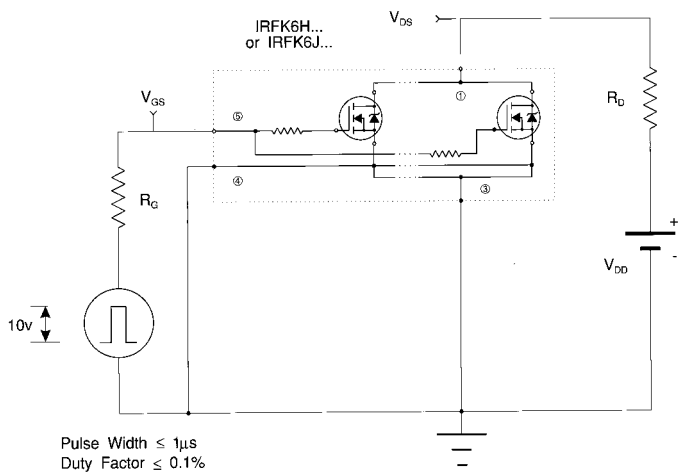

Fig 11a. Switching Time Test Circuit

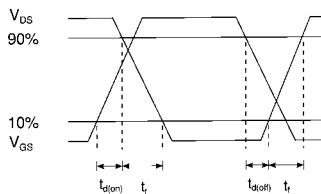
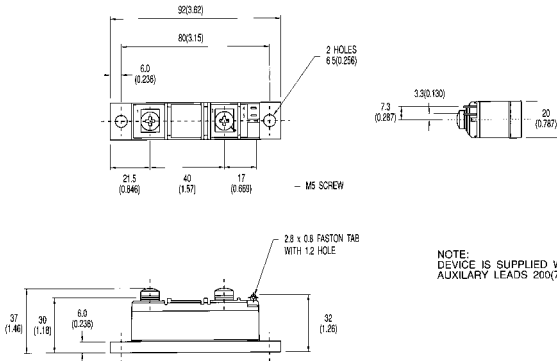
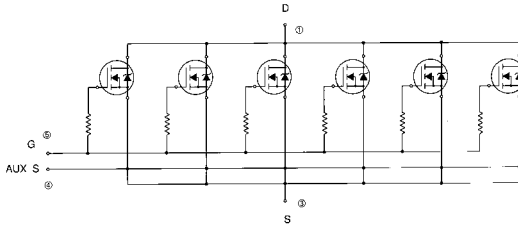

Fig 11b. Switching Time Waveforms



IRFK6HC50, IRFK6JC50

Circuit Configuration and Outline



All dimensions in millimetres (inches)

IRFK6HC50, IRFK6JC50



Part Numbering

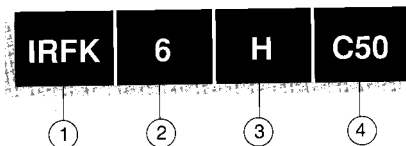

1. - HEX-pak Module.
2. - Number of HEXFETs in parallel.
3. - H - Fast switching.
- J - Oscillation resistant for sensitive applications.
4. - Voltage code:-
054 - 60V
150 - 100V
250 - 200V
350 - 400V
450 - 500V
C50 - 600V

WORLD HEADQUARTERS: 233 Kansas St., EL SEGUNDO, California 90245, USA. Tel:(213) 772-2000. Tlx:664464. Fax:(213) 772-9028
EUROPEAN HEADQUARTERS: Hurst Green, OXTED, Surrey RH8 9BB, U.K. Tel:(0883) 713215. Tlx:95219. Fax:(0883)714234.

CANADA: 101 Bentley St., Markham, ONTARIO L3R 3L1. Tel:(416)475-1897. Tlx:06-966-650. Fax:(416)475-8801
CZECHOSLOVAKIA: Maturova 19/1555, Box 30, 140 00 PRAGUE. Tel:(2) 792 6831. Fax:(2) 792 6831.

DENMARK: P.O. Box 70, Krogstoejvej 51, DK-2880 BAGSVAERD. Tel: (45) 44 37 71 50. Fax (45) 44 37 71 52.

FRANCE: 123 Rue de Petit Vaux, 91360 EPINAY sur ORGE. Tel:(1)64.54.83.23. Tlx:600943. Fax:(1)64.54.83.30.

FINLAND: Billskogsvägen 19, 02580 Sjunnså St. Tel:(0) 262 8144. Fax:(0) 262 8150.

GERMANY: Saalburgstr. 157, D-6380 BAD HOMBURG. Tel:(61)72-37066. Tlx:410404. Fax:(61)72-37065.

HUNGARY: Szent Istvan Park 15, H-1157 BUDAPEST. Tel:(1) 1296 622. Fax:(1) 1298 822.

HONG KONG: 222 Peter Building, 60 Queens Road Central, HONG KONG. Tel:(85) 252 36355. Fax: (85) 284 52908.

ITALY: Via Liguria 49, 10071 Borgaro, TORINO. Tel:(011)470 14 84. Tlx:221257. Fax:(011)470 42 90.

USA: Via Zucca 8, 20017 Rho MILANO. Tel:(02)93 50 36 50. Fax:(02)93 50 36 55.

INDIA: Arno 1, 40139 BOLOGNA. Tel:(05)49 33 07. Fax:(05)149 54 80.

JAPAN: 31 Cosenszono, 5 Union Park, Kihar (W), BOMBAY 400 052. Tel:(022)535026/633779/540242. Tlx:011-71481.

K & H Bldg. 2F, 3-30-4 Nishi-Kabukuro, Toshima-ku, TOKYO, Japan 171. Tel:(03)983 0641. Fax:(03)983 0642.

SINGAPORE: HEX 10-01 Fortune Centre, 190 Middle Road, SINGAPORE 0718. Tel:(65)398 3922/337 4695/336 6286. Fax: (65)397 4662.

SWEDEN: Box: 85, S-162 12 Valmingby 1, STOCKHOLM. Tel:(08)8770035. Fax:(08)6174242.

SWITZERLAND: CH-8032 ZURICH, Kirchenweg 5. Tel:(01)386 6702/6586. Fax:(01)383 5108/2379.

U.S.A.:

Central Zone: 2401 Plum Grove Road, Suite 111, PALATINE, IL60067. Tel:(312)397-0002. Fax:(312)397-0114.

Eastern Zone: 71 Grand Avenue, PALISADES PARK, NJ07850. Tel:(201)943-4554. Fax:(201)943-5754.

Southern Zone: 800 Office Plaza Blvd., Suite 401, KISSIMMEE, FL32743. Tel:(407)933-2383. Fax:(407)933-2293.

Western Zone: 222 Kansas Street, EL SEGUNDO, CA92445. Tel:(213)637-8896. Fax:(213)640-6533.

Sales Offices, Agents and Distributors in Major Cities throughout the World.

In the interest of product improvement INTERNATIONAL RECTIFIER reserves the right to change specifications at any time without notice.

MJW/182