

MITSUBISHI Nch POWER MOSFET

FK7SM-12

HIGH-SPEED SWITCHING USE

FK7SM-12



- V_{DSS} 600V
- r_{DS (ON)} (MAX) 1.63Ω
- I_D 7A
- Integrated Fast Recovery Diode (MAX.) 150ns

OUTLINE DRAWING

Dimensions in mm

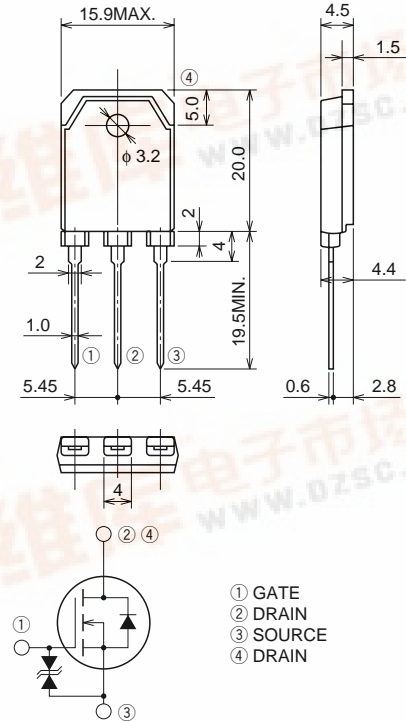

APPLICATION

Servo motor drive, Robot, UPS, Inverter Fluorecent lamp, etc.

MAXIMUM RATINGS (T_c = 25°C)

Symbol	Parameter	Conditions	Ratings	Unit
V _{DSS}	Drain-source voltage	V _{GS} = 0V	600	V
V _{GSS}	Gate-source voltage	V _{DS} = 0V	±30	V
I _D	Drain current		7	A
I _{DM}	Drain current (Pulsed)		21	A
I _S	Source current		7	A
I _{SM}	Source current (Pulsed)		21	A
P _D	Maximum power dissipation		125	W
T _{ch}	Channel temperature		-55 ~ +150	°C
T _{stg}	Storage temperature		-55 ~ +150	°C
—	Weight	Typical value	4.8	g

FK7SM-12

HIGH-SPEED SWITCHING USE

ELECTRICAL CHARACTERISTICS (Tch = 25°C)

Symbol	Parameter	Test conditions	Limits			Unit
			Min.	Typ.	Max.	
V (BR) DSS	Drain-source breakdown voltage	Id = 1mA, VGS = 0V	600	—	—	V
V (BR) GSS	Gate-source breakdown voltage	IG = ±100μA, VDS = 0V	±30	—	—	V
IGSS	Gate-source leakage current	VGS = ±25V, VDS = 0V	—	—	±10	μA
IDSS	Drain-source leakage current	VDS = 600V, VGS = 0V	—	—	1	mA
VGS (th)	Gate-source threshold voltage	Id = 1mA, VDS = 10V	2	3	4	V
rDS (ON)	Drain-source on-state resistance	Id = 3A, VGS = 10V	—	1.25	1.63	Ω
VDS (ON)	Drain-source on-state voltage	Id = 3A, VGS = 10V	—	3.75	4.89	V
yfs	Forward transfer admittance	Id = 3A, VDS = 10V	3.3	5.5	—	S
Ciss	Input capacitance	VDS = 25V, VGS = 0V, f = 1MHz	—	1100	—	pF
Coss	Output capacitance		—	125	—	pF
Crss	Reverse transfer capacitance		—	17	—	pF
td (on)	Turn-on delay time	VDD = 200V, Id = 3A, VGS = 10V, RGEN = RGS = 50Ω	—	30	—	ns
tr	Rise time		—	30	—	ns
td (off)	Turn-off delay time		—	100	—	ns
tf	Fall time		—	35	—	ns
VSD	Source-drain voltage	IS = 3A, VGS = 0V	—	1.5	2.0	V
Rth (ch-c)	Thermal resistance	Channel to case	—	—	1.00	°C/W
trr	Reverse recovery time	IS = 7A, dis/dt = -100A/μs	—	—	150	ns

PERFORMANCE CURVES

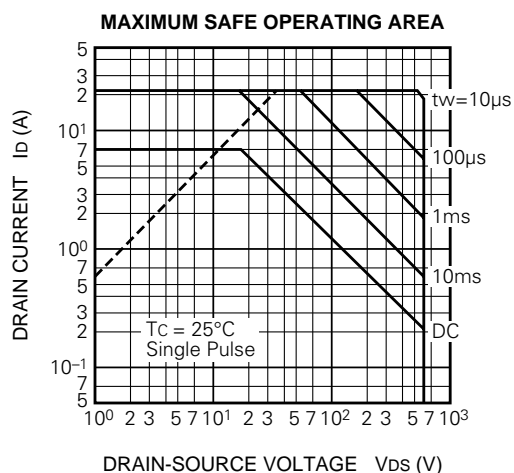
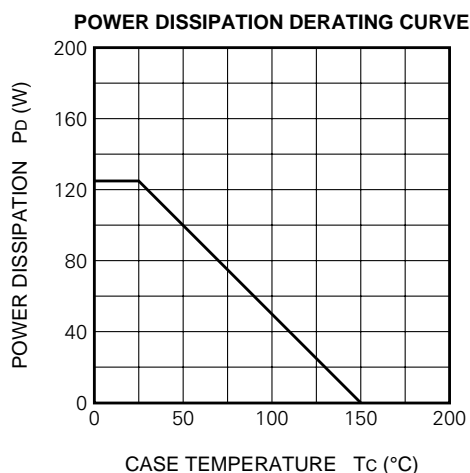

FK7SM-12

HIGH-SPEED SWITCHING USE

OUTPUT CHARACTERISTICS (TYPICAL)

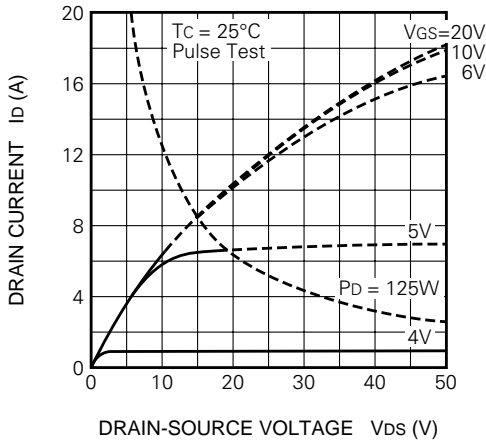

OUTPUT CHARACTERISTICS (TYPICAL)

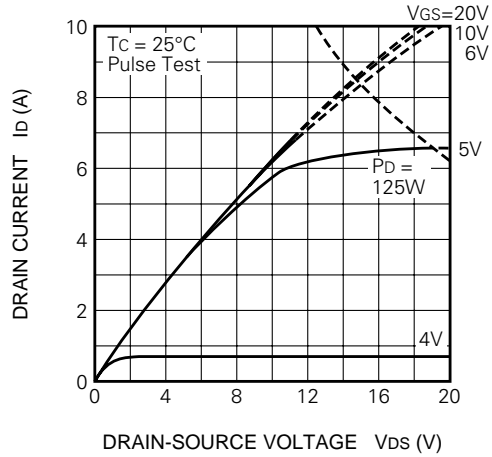

ON-STATE VOLTAGE VS. GATE-SOURCE VOLTAGE (TYPICAL)

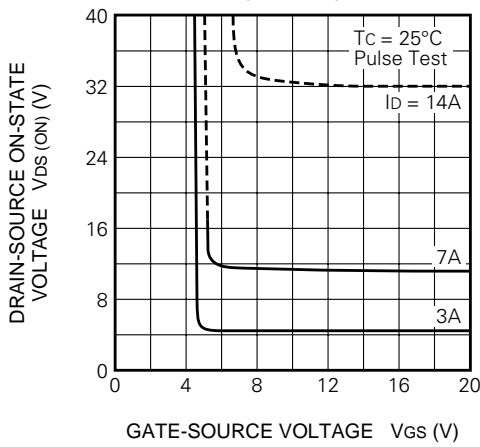

ON-STATE RESISTANCE VS. DRAIN CURRENT (TYPICAL)

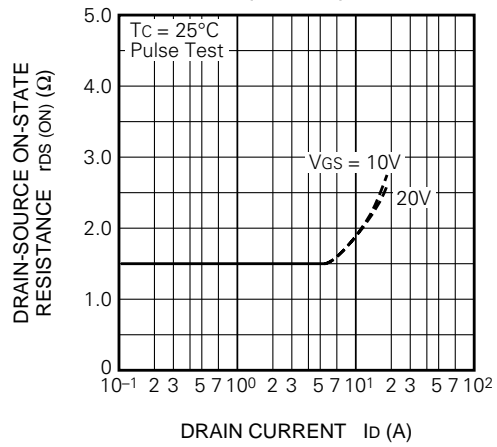

TRANSFER CHARACTERISTICS (TYPICAL)

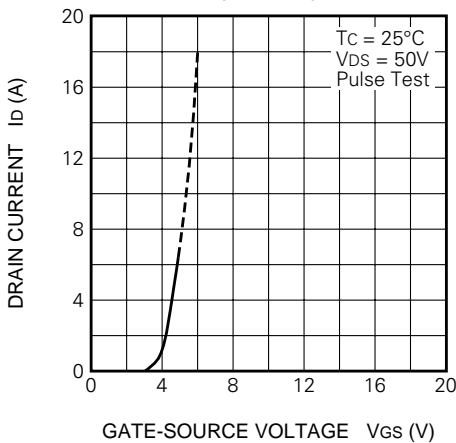

FORWARD TRANSFER ADMITTANCE VS. DRAIN CURRENT (TYPICAL)

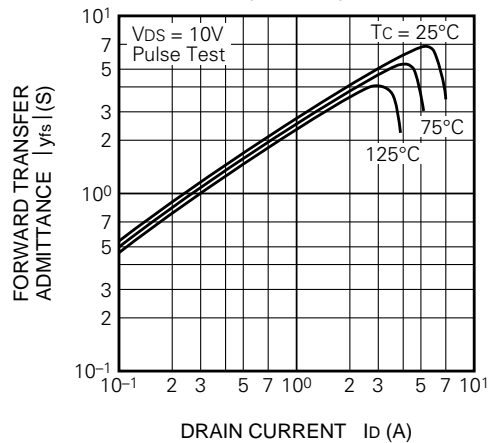

FK7SM-12

HIGH-SPEED SWITCHING USE

CAPACITANCE VS. DRAIN-SOURCE VOLTAGE (TYPICAL)

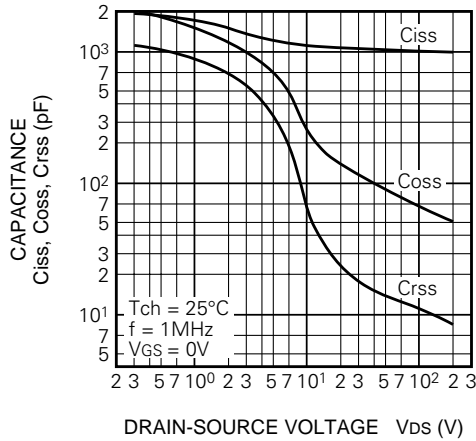

SWITCHING CHARACTERISTICS (TYPICAL)

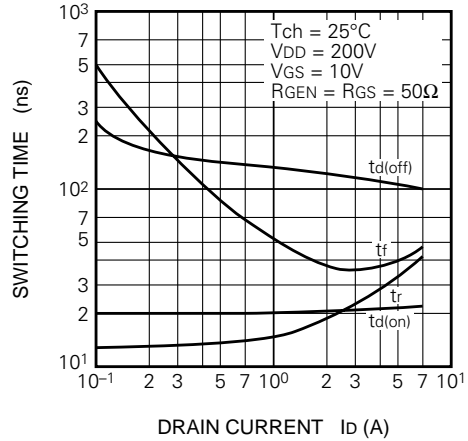

GATE-SOURCE VOLTAGE VS. GATE CHARGE (TYPICAL)

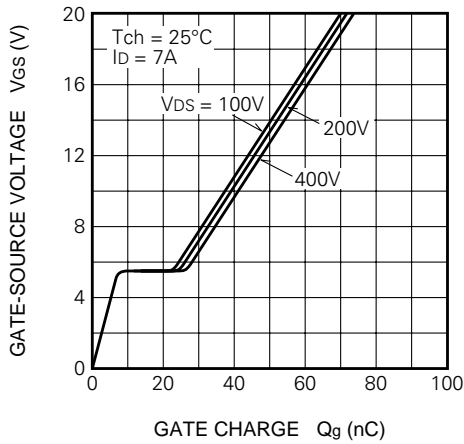

SOURCE-DRAIN DIODE FORWARD CHARACTERISTICS (TYPICAL)

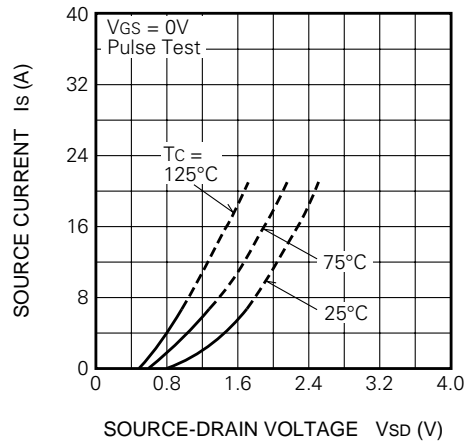

ON-STATE RESISTANCE VS. CHANNEL TEMPERATURE (TYPICAL)

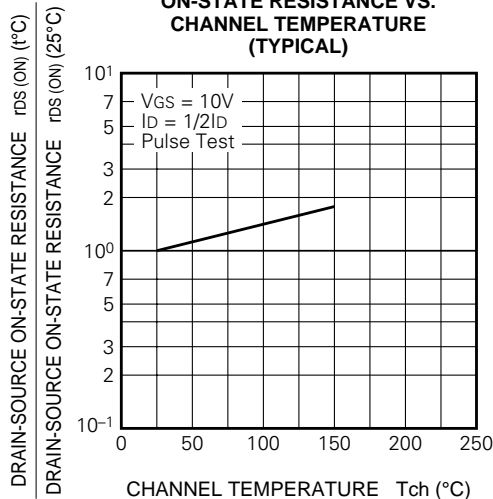

THRESHOLD VOLTAGE VS. CHANNEL TEMPERATURE (TYPICAL)

