

FAIRCHILD
SEMICONDUCTOR®

IGBT

FMG1G75US60H

Molding Type Module

General Description

Fairchild's Insulated Gate Bipolar Transistor (IGBT) power modules provide low conduction and switching losses as well as short circuit ruggedness. They are designed for applications such as motor control, uninterrupted power supplies (UPS) and general inverters where short circuit ruggedness is a required feature.

Features

- UL Certified No. E209204
- Short Circuit rated 10us @ $T_C = 100^\circ\text{C}$, $V_{GE} = 15\text{V}$
- High Speed Switching
- Low Saturation Voltage : $V_{CE(sat)} = 2.2\text{V}$ @ $I_C = 75\text{A}$
- High Input Impedance
- Fast & Soft Anti-Parallel FWD

Application

- AC & DC Motor Controls
- General Purpose Inverters
- Robotics
- Servo Controls
- UPS



Package Code : 7PM-GA

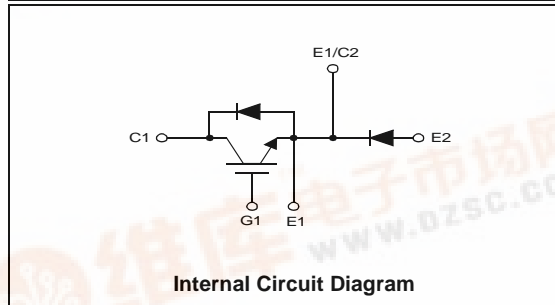

Internal Circuit Diagram

Absolute Maximum Ratings $T_C = 25^\circ\text{C}$ unless otherwise noted

Symbol	Description	FMG1G75US60H	Units
V_{CES}	Collector-Emitter Voltage	600	V
V_{GES}	Gate-Emitter Voltage	± 20	V
I_C	Collector Current @ $T_C = 25^\circ\text{C}$	75	A
$I_{CM(1)}$	Pulsed Collector Current	150	A
I_F	Diode Continuous Forward Current @ $T_C = 100^\circ\text{C}$	75	A
I_{FM}	Diode Maximum Forward Current	150	A
T_{SC}	Short Circuit Withstand Time @ $T_C = 100^\circ\text{C}$	10	us
P_D	Maximum Power Dissipation @ $T_C = 25^\circ\text{C}$	310	W
T_J	Operating Junction Temperature	-40 to +150	$^\circ\text{C}$
T_{stg}	Storage Temperature Range	-40 to +125	$^\circ\text{C}$
V_{iso}	Isolation Voltage @ AC 1minute	2500	V
Mounting Torque	Power Terminals Screw : M5	2.0	N.m
	Mounting Screw : M5	2.0	N.m

Notes :

(1) Repetitive rating : Pulse width limited by max. junction temperature



Electrical Characteristics of IGBT T_C = 25°C unless otherwise noted

Symbol	Parameter	Test Conditions	Min.	Typ.	Max.	Units
Off Characteristics						
BV_{CES}	Collector-Emitter Breakdown Voltage	$V_{GE} = 0V, I_C = 250\mu A$	600	--	--	V
$\frac{\Delta BV_{CES}}{\Delta T_J}$	Temperature Coeff. of Breakdown Voltage	$V_{GE} = 0V, I_C = 1mA$	--	0.6	--	V/°C
I_{CES}	Collector Cut-Off Current	$V_{CE} = V_{CES}, V_{GE} = 0V$	--	--	250	μA
I_{GES}	G-E Leakage Current	$V_{GE} = V_{GES}, V_{CE} = 0V$	--	--	± 100	nA
On Characteristics						
$V_{GE(th)}$	G-E Threshold Voltage	$V_{GE} = 0V, I_C = 75mA$	5.0	6.0	8.5	V
$V_{CE(sat)}$	Collector to Emitter Saturation Voltage	$I_C = 75A, V_{GE} = 15V$	--	2.2	2.8	V
Dynamic Characteristics						
C_{ies}	Input Capacitance	$V_{CE} = 30V, V_{GE} = 0V,$ $f = 1MHz$	--	7056	--	pF
C_{oes}	Output Capacitance		--	672	--	pF
C_{res}	Reverse Transfer Capacitance		--	180	--	pF
Switching Characteristics						
$t_{d(on)}$	Turn-On Delay Time	$V_{CC} = 300V, I_C = 75A,$ $R_G = 3.3\Omega, V_{GE} = 15V$ Inductive Load, $T_C = 25^\circ C$	--	20	--	ns
t_r	Rise Time		--	40	--	ns
$t_{d(off)}$	Turn-Off Delay Time		--	70	--	ns
t_f	Fall Time		--	110	200	ns
E_{on}	Turn-On Switching Loss		--	1.4	--	mJ
E_{off}	Turn-Off Switching Loss		--	1.7	--	mJ
E_{ts}	Total Switching Loss	--	3.1	--	mJ	
$t_{d(on)}$	Turn-On Delay Time	$V_{CC} = 300V, I_C = 75A,$ $R_G = 3.3\Omega, V_{GE} = 15V$ Inductive Load, $T_C = 125^\circ C$	--	20	--	ns
t_r	Rise Time		--	50	--	ns
$t_{d(off)}$	Turn-Off Delay Time		--	80	--	ns
t_f	Fall Time		--	250	--	ns
E_{on}	Turn-On Switching Loss		--	1.6	--	mJ
E_{off}	Turn-Off Switching Loss		--	3.0	--	mJ
E_{ts}	Total Switching Loss	--	4.6	--	mJ	
T_{sc}	Short Circuit Withstand Time	$V_{CC} = 300V, V_{GE} = 15V$ @ $T_C = 100^\circ C$	10	--	--	us
Q_g	Total Gate Charge	$V_{CE} = 300V, I_C = 75A,$ $V_{GE} = 15V$	--	310	350	nC
Q_{ge}	Gate-Emitter Charge		--	62	--	nC
Q_{gc}	Gate-Collector Charge		--	130	--	nC

Electrical Characteristics of DIODE $T_C = 25^\circ\text{C}$ unless otherwise noted

Symbol	Parameter	Test Conditions	Min.	Typ.	Max.	Units	
V_{FM}	Diode Forward Voltage	$I_F = 75\text{A}$	$T_C = 25^\circ\text{C}$	--	1.9	2.8	V
			$T_C = 100^\circ\text{C}$	--	1.8	--	
t_{rr}	Diode Reverse Recovery Time		$T_C = 25^\circ\text{C}$	--	90	130	ns
			$T_C = 100^\circ\text{C}$	--	130	--	
I_{rr}	Diode Peak Reverse Recovery Current	$I_F = 75\text{A}$ $di / dt = 150 \text{ A/us}$	$T_C = 25^\circ\text{C}$	--	7	9	A
			$T_C = 100^\circ\text{C}$	--	10	--	
Q_{rr}	Diode Reverse Recovery Charge		$T_C = 25^\circ\text{C}$	--	315	590	nC
			$T_C = 100^\circ\text{C}$	--	650	--	

Thermal Characteristics

Symbol	Parameter	Typ.	Max.	Units
$R_{\theta JC}$	Junction-to-Case (IGBT Part, per 1/2 Module)	--	0.4	$^\circ\text{C/W}$
$R_{\theta JC}$	Junction-to-Case (DIODE Part, per 1/2 Module)	--	0.9	$^\circ\text{C/W}$
$R_{\theta CS}$	Case-to-Sink (Conductive grease applied)	0.05	--	$^\circ\text{C/W}$
Weight	Weight of Module	--	190	g

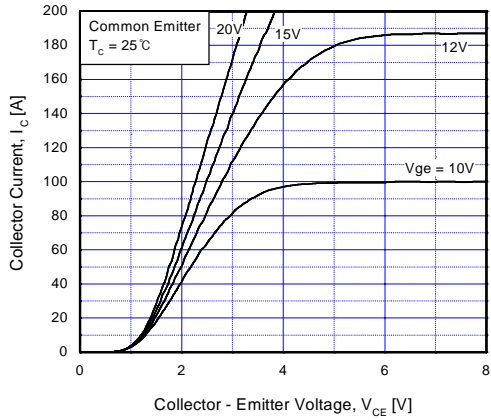

Fig 1. Typical Output Characteristics

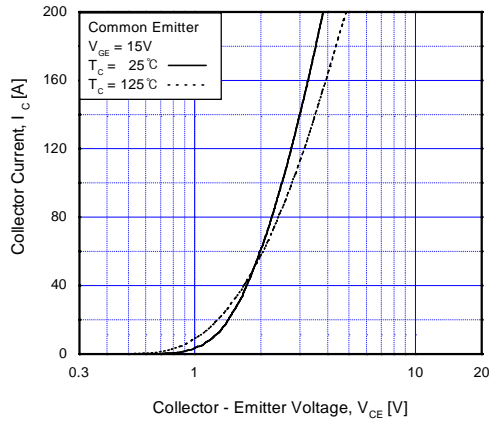

Fig 2. Typical Saturation Voltage Characteristics

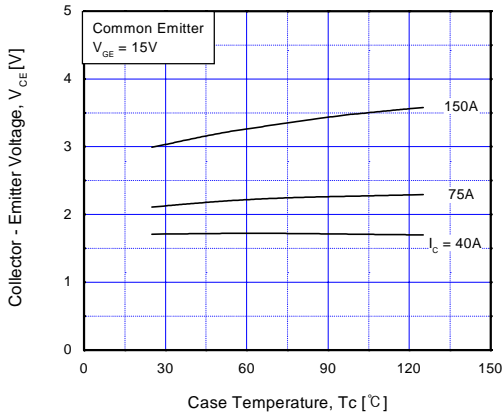

Fig 3. Saturation Voltage vs. Case Temperature at Variant Current Level

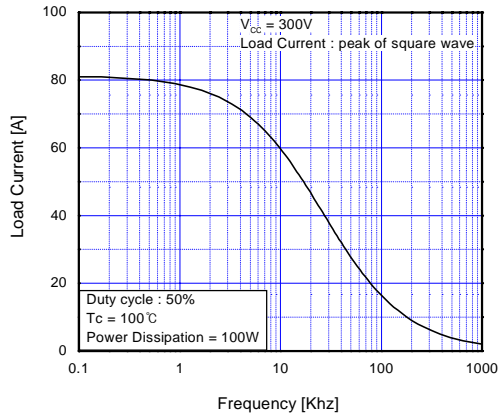

Fig 4. Load Current vs. Frequency

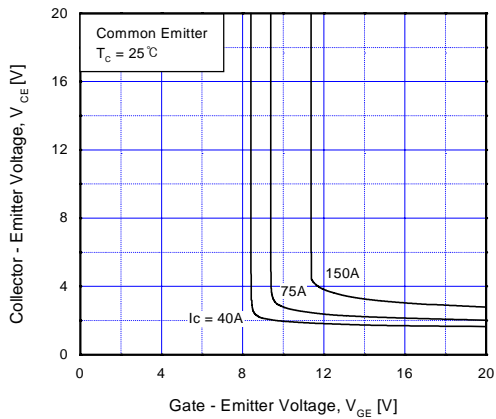

Fig 5. Saturation Voltage vs. V_{GE}

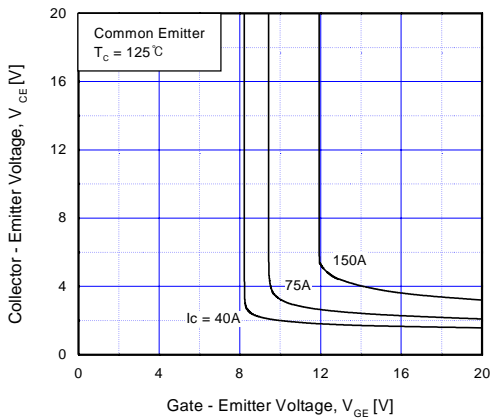

Fig 6. Saturation Voltage vs. V_{GE}

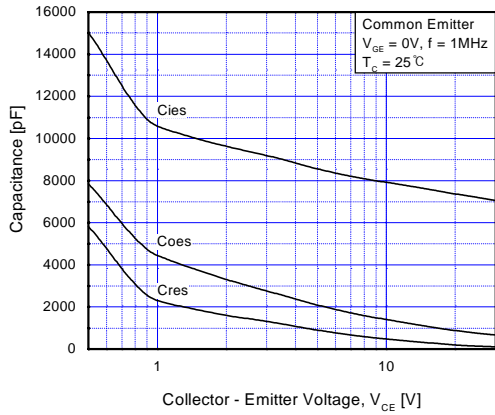

Fig 7. Capacitance Characteristics

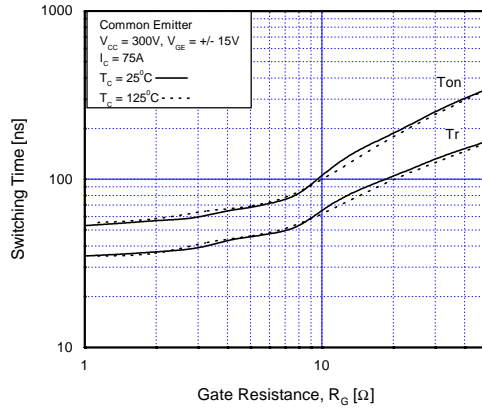

Fig 8. Turn-On Characteristics vs. Gate Resistance

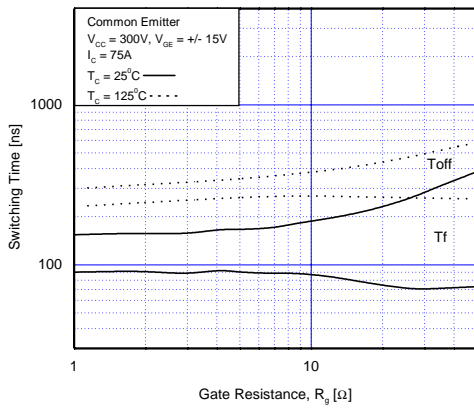

Fig 9. Turn-Off Characteristics vs. Gate Resistance

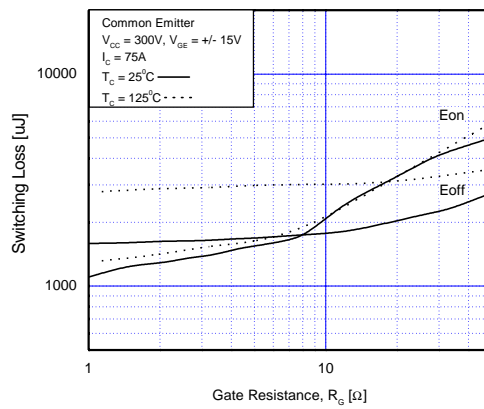

Fig 10. Switching Loss vs. Gate Resistance

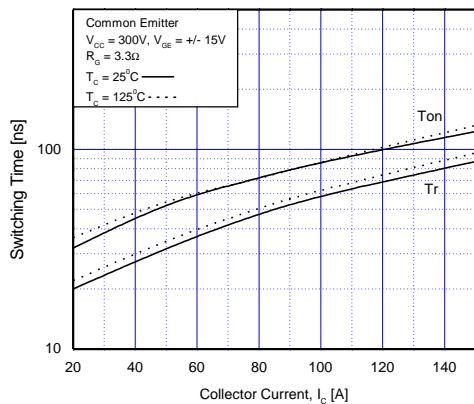

Fig 11. Turn-On Characteristics vs. Collector Current

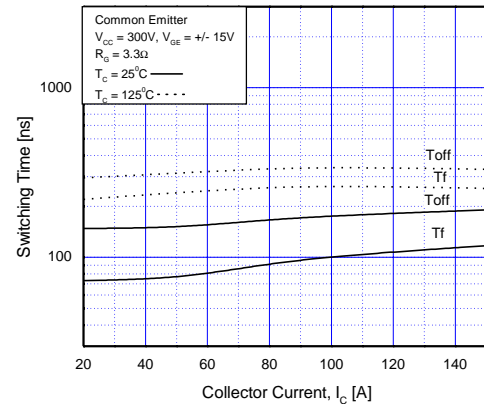

Fig 12. Turn-Off Characteristics vs. Collector Current

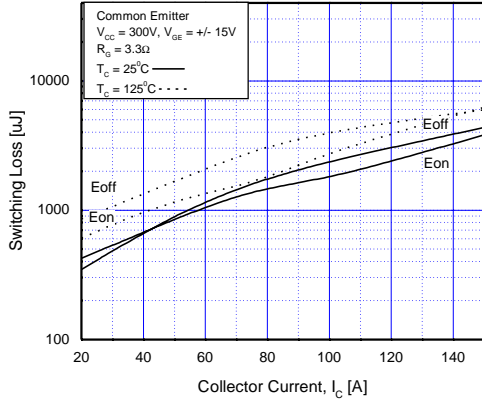

Fig 13. Switching Loss vs. Collector Current

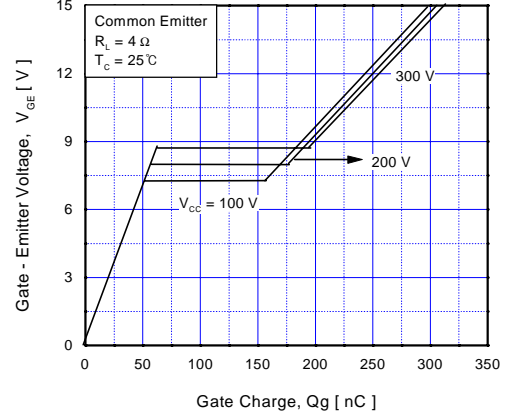

Fig 14. Gate Charge Characteristics

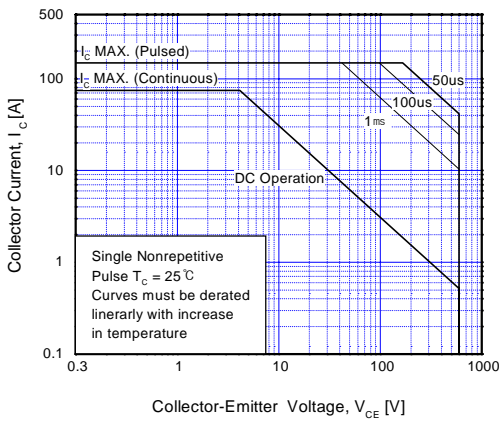

Fig 15. SOA Characteristics

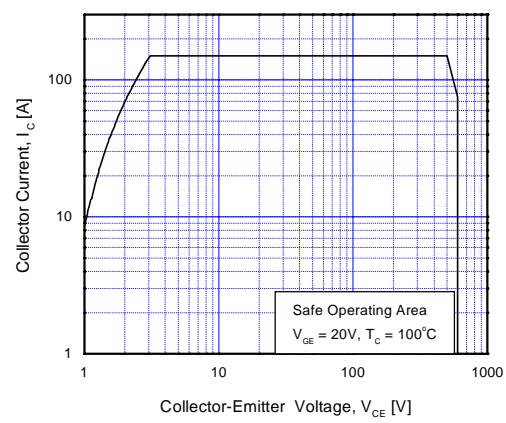

Fig 16. Turn-Off SOA Characteristics

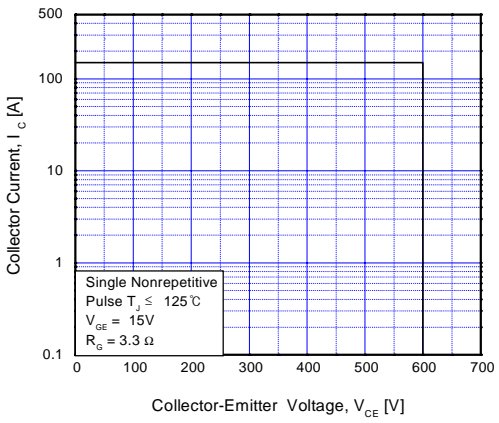

Fig 17. RBSOA Characteristics

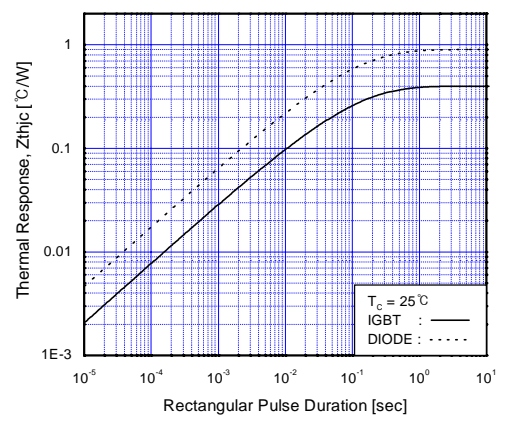

Fig 18. Transient Thermal Impedance

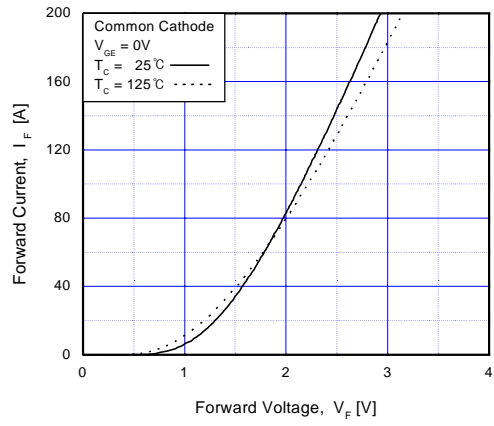

Fig 19. Forward Characteristics

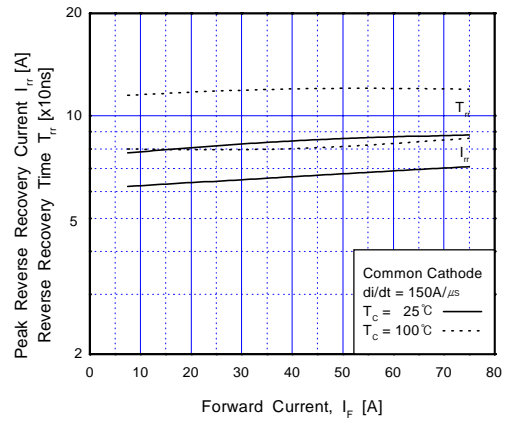
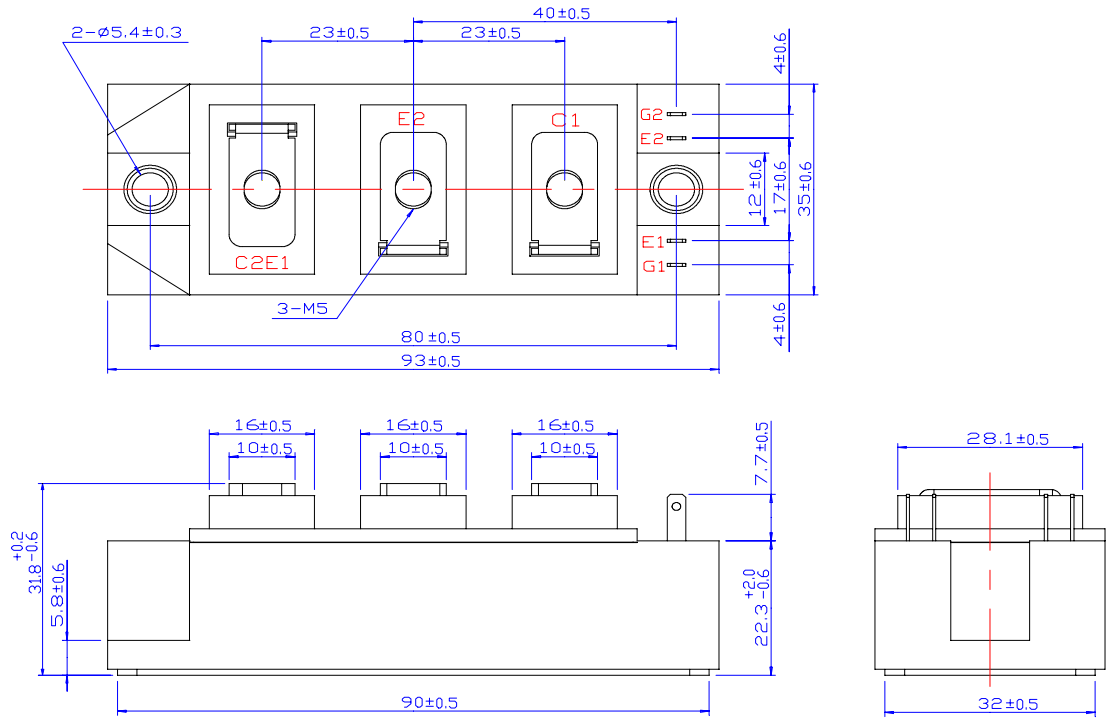

Fig 20. Reverse Recovery Characteristics

Package Dimension

7PM-GA



Dimensions in Millimeters

TRADEMARKS

The following are registered and unregistered trademarks Fairchild Semiconductor owns or is authorized to use and is not intended to be an exhaustive list of all such trademarks.

ACE ^x ™	FAST [®]	MICROWIRE™	SILENT SWITCHER [®]	UHC™
Bottomless™	FAST ^r ™	OPTOLOGIC [®]	SMART START™	UltraFET [®]
CoolFET™	FRFET™	OPTOPLANAR™	SPM™	VCX™
CROSSVOLT™	GlobalOptoisolator™	PACMAN™	STAR*POWER™	
DenseTrench™	GTO™	POP™	Stealth™	
DOME™	HiSeC™	Power247™	SuperSOT™-3	
EcoSPARK™	I ² C™	PowerTrench [®]	SuperSOT™-6	
E ² CMOS™	ISOPLANAR™	QFET™	SuperSOT™-8	
EnSigna™	LittleFET™	QS™	SyncFET™	
FACT™	MicroFET™	QT Optoelectronics™	TinyLogic™	
FACT Quiet Series™	MicroPak™	Quiet Series™	TruTranslation™	

STAR*POWER is used under license

DISCLAIMER

FAIRCHILD SEMICONDUCTOR RESERVES THE RIGHT TO MAKE CHANGES WITHOUT FURTHER NOTICE TO ANY PRODUCTS HEREIN TO IMPROVE RELIABILITY, FUNCTION OR DESIGN. FAIRCHILD DOES NOT ASSUME ANY LIABILITY ARISING OUT OF THE APPLICATION OR USE OF ANY PRODUCT OR CIRCUIT DESCRIBED HEREIN; NEITHER DOES IT CONVEY ANY LICENSE UNDER ITS PATENT RIGHTS, NOR THE RIGHTS OF OTHERS.

LIFE SUPPORT POLICY

FAIRCHILD'S PRODUCTS ARE NOT AUTHORIZED FOR USE AS CRITICAL COMPONENTS IN LIFE SUPPORT DEVICES OR SYSTEMS WITHOUT THE EXPRESS WRITTEN APPROVAL OF FAIRCHILD SEMICONDUCTOR CORPORATION. As used herein:

1. Life support devices or systems are devices or systems which, (a) are intended for surgical implant into the body, or (b) support or sustain life, or (c) whose failure to perform when properly used in accordance with instructions for use provided in the labeling, can be reasonably expected to result in significant injury to the user.
2. A critical component is any component of a life support device or system whose failure to perform can be reasonably expected to cause the failure of the life support device or system, or to affect its safety or effectiveness.

PRODUCT STATUS DEFINITIONS

Definition of Terms

Datasheet Identification	Product Status	Definition
Advance Information	Formative or In Design	This datasheet contains the design specifications for product development. Specifications may change in any manner without notice.
Preliminary	First Production	This datasheet contains preliminary data, and supplementary data will be published at a later date. Fairchild Semiconductor reserves the right to make changes at any time without notice in order to improve design.
No Identification Needed	Full Production	This datasheet contains final specifications. Fairchild Semiconductor reserves the right to make changes at any time without notice in order to improve design.
Obsolete	Not In Production	This datasheet contains specifications on a product that has been discontinued by Fairchild semiconductor. The datasheet is printed for reference information only.