

Compact high-performance module FN 9222

- Up to 20A current ratings
- IEC 950-compliant
- Optional medical version (B type)
- Snap-in version (S and S1 type)

- Nennstrom bis 20A
- IEC 950 konform
- Für medizinische Geräte als Option (Typ B)
- Snap-in Version (Typ S und S1)

- Courants de service pouvant atteindre 20A
- Conforme à CEI 950
- Version médicale en option (type B)
- Version snap-in (type S et S1)



Filter selection table

Choose the family FN xxx with the required body style and features, and add -?? to determine current rating, and /?? for output connections. Example: FN 9222-1/06 is a horizontal screw-mounting filter, rated for 1A, with fast-on outputs.

Approvals



1Family	Current ratings A at 50°C (40°)								Output connection	Housing
	1 (1.2)	3 (3.5)	6 (7.2)	10 (11.6)	10 (12)	10 (15)	16 (18.5)	20 (23)		
FN 9222 -?? /??	-1	-3	-6	-10	-12	-15	-16	-20	/06 /07	■
FN 9222S -?? /??	-1	-3	-6	-10	-12	-15			/06 /07	■
FN 9222S1 -?? /??	-1	-3	-6	-10	-12	-15			/06 /07	■
Inductance L mH										
	12	2.5	0.78	0.225	0.11	0.075	0.54	0.4		

Additional specifications

Filter type	Capacitance		Maximum leakage μA/phase	Res. R MΩ	Weight g	Maximum operating volt.		Operating frequency Hz	Hipot test voltage	
	Cx nF	Cy nF				VAC	Hz		PN→E VAC	P→N VDC
Standard types (up to 15A)	100	2.2	190		40	250	50/60	DC to 400	2000	1700
R types (up to 15A)	100	2.2	190	1	40	250	50/60	DC to 400	2000	1700
R types (16/20A)	330	2.2	190	1	120	250	50/60	DC to 400	2000	1700
B types (medical, up to 15A)	100		2	1	40	250	50/60	DC to 400	2500	1700
B types (medical, 16/20A)	330		2	1	120	250	50/60	DC to 400	2500	1700

MTBF at 40°C, 230V, per Mil-HB-217F: 1,800,000 hours

Temperature range: -25°C – +85°C

Please note that 16A and 20A filters are only available as R-types (FN 9222R-16-06 and FN9222R-20-06) with resistor.

FN 9222 insertion loss

Per CISPR 17; A = 50Ω/50Ω sym, B = 50Ω/50Ω asym, C = 0.1Ω/100Ω sym, D = 100Ω/0.1Ω sym

1 amp types

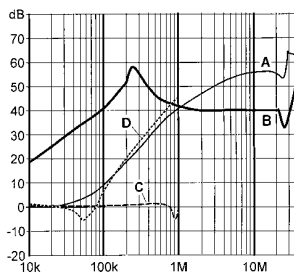

3 amp types

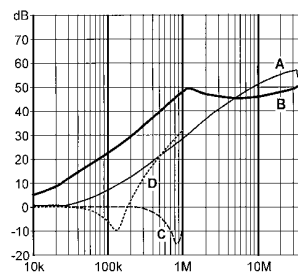

6 amp types

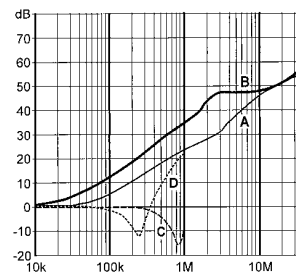

10 amp types

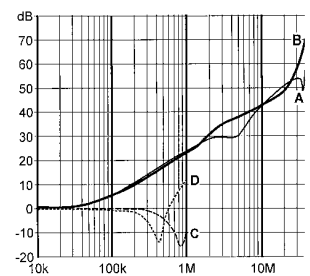

12 amp types

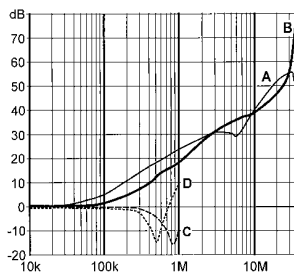

15 amp types

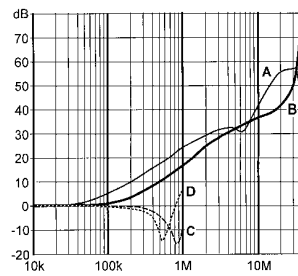

16 amp types

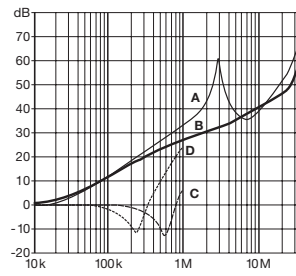

20 amp types

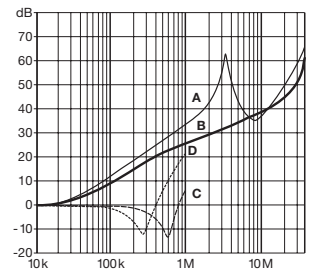

Electrical schematics

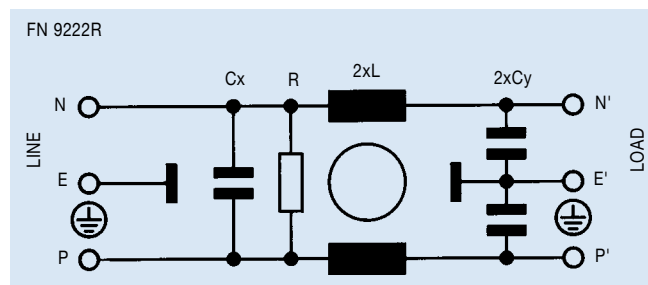
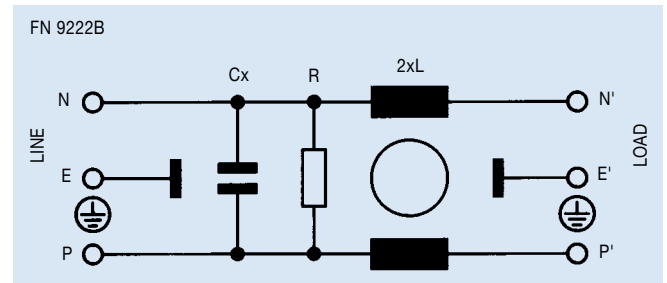
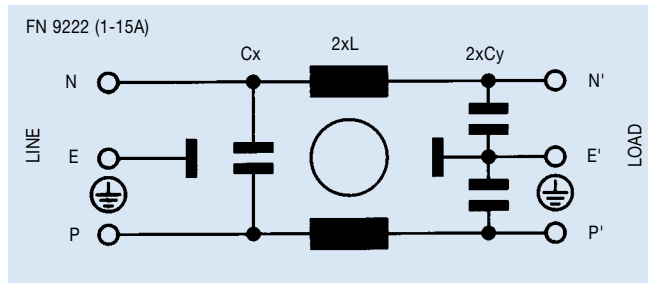

See tables for component values

Mechanical data

FN 9222

1 to 6A 10 to 15A 16-20A

A	48	53
B	22.5	30
C	40	42
D	38.4	73
F	5.5	
H	Ø3.3	Ø3.5
J	13.3	-
M	R<3	-
N	21.5 ^{+0.5} ₀	27
P	28.5 ^{+0.5} ₀	34.7
R	M3	
S	90°	
W	6	
Y	AWG 18	AWG 16
Z	160	

FN 9222 up to 15A

Front

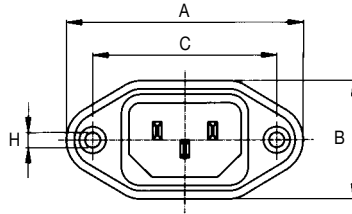

Side /06

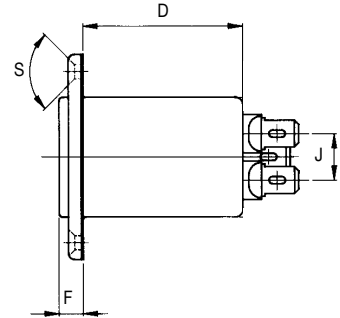

**FN 9222 12 and 15A
(versions with IEC hot inlet)**

Front

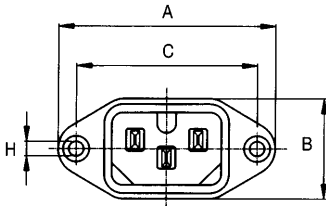

FN 9222x-12-xxHI
FN 9222x-15-xxHI

Panel cut-out

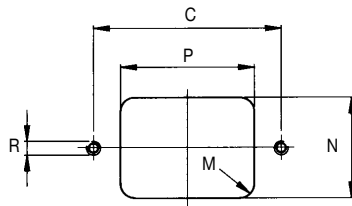

Side /07*

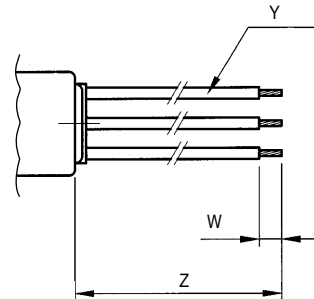

FN 9222R 16 and 20A

Rear

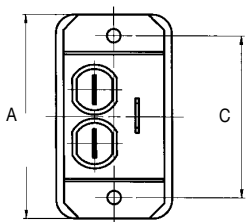

Side

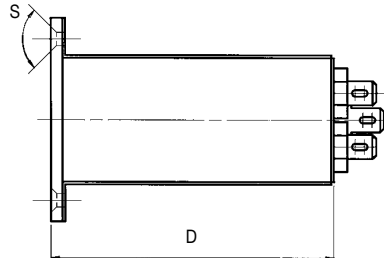

Front

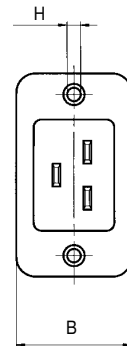

Panel cut-out

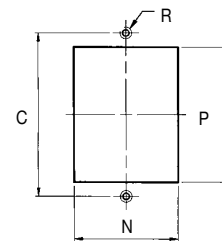

* FN 9222 filters with wire connections (/07) are currently in preparation. Their mechanical dimensions are subject to minor adjustments. Please contact your local Schaffner office for details.

Mechanical data

FN 9222S

1 to 6A 10 to 15A

A	29.9	
B	22.4	
C	27.8	
D	38.4	
F	5.5	
J	13.3	
M	R≤1.5	
N	20.8 ^{+0.1} ₋₀	
P	29.4 ^{+0.1} ₋₀	
T	panel thickness 0.6-1.6mm	
W	6	
Y	AWG 18	AWG 16
Z	160	

Snap-in version FN 9222S

(For installation instructions see page 92)

Front

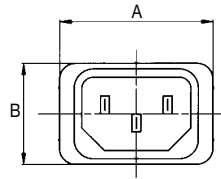

Side /06

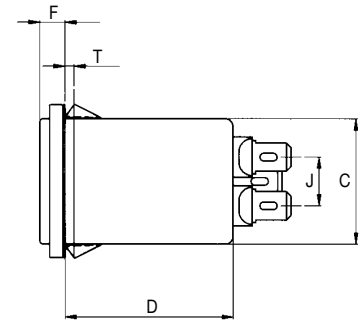

Panel cut-out

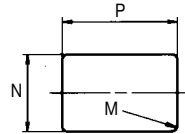

Side /07*

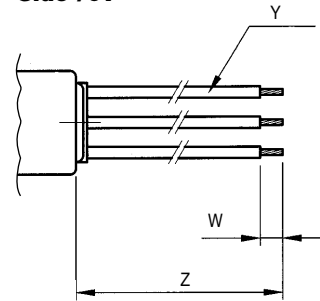

FN 9222S1

1 to 6A 10 to 15A

A	29.9	
B	22.4	
C	27.8	
D	38.4	
F	5.5	
J	13.3	
M	R≤1.5	
N	21.9 ^{+0.1} ₋₀	
P	28.5 ^{+0.1} ₋₀	
T	panel thickness 0.6-1.6mm	
W	6	
Y	AWG 18	AWG 16
Z	160	

Snap-in version FN 9222S1

(For installation instructions see page 92)

Front

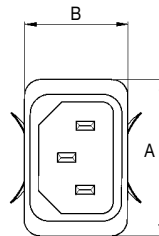

Side /06

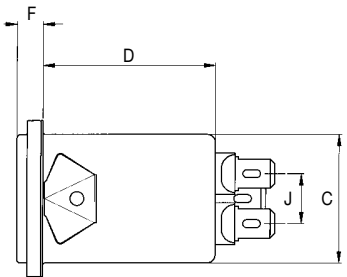

Panel cut-out

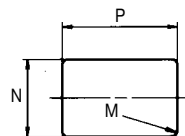

Side /07*

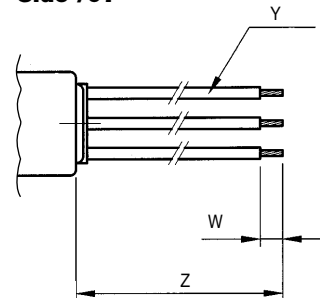

* FN 9222 filters with wire connection (/07) are currently in preparation. Their mechanical dimensions are subject to minor adjustments. Please contact your local Schaffner office for details.