



# 4-PIN FULL PITCH MINI-FLAT PACKAGE RANDOM-PHASE TRIAC DRIVER OUTPUT OPTOCOUPLERS

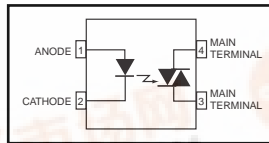
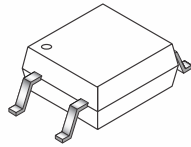
**FODM3010    FODM3011    FODM3012    FODM3021    FODM3022    FODM3023**

## DESCRIPTION

The FODM301X and FODM302X series consists of a GaAs infrared emitting diode driving a silicon bilateral switch housed in a compact 4-pin mini-flat package. The lead pitch is 2.54 mm. They are designed for interfacing between electronic controls and power triacs to control resistive and inductive loads for 115V/240V operations.

## FEATURES

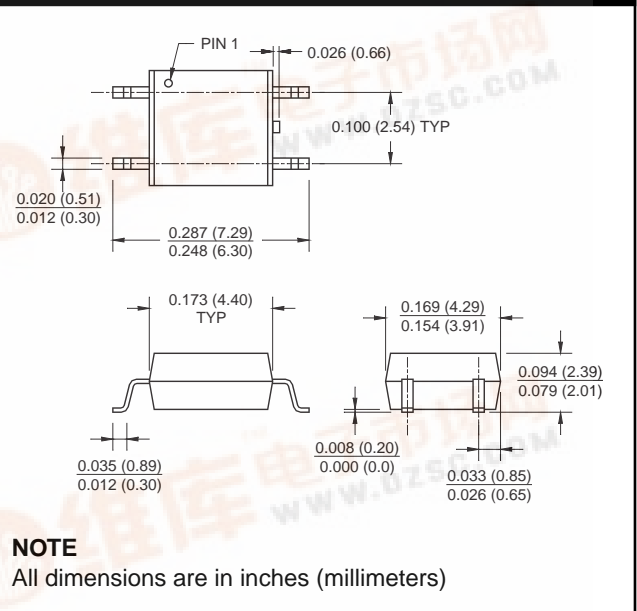
- Compact 4-pin surface mount package (2.4 mm maximum standoff height)
- Peak blocking voltage  
250V (FODM301X)  
400V (FODM302X)
- Available in tape and reel quantities of 500 and 2500.
- Applicable to Infrared Ray reflow (230°C max, 30 seconds.)
- BSI, CSA and VDE certifications pending
- UL (File# E90700) certified



## APPLICATIONS

- Industrial controls
- Traffic lights
- Vending machines
- Solid state relay
- Lamp ballasts
- Solenoid/valve controls
- Static AC power switch
- Incandescent lamp dimmers
- Motor control

## PACKAGE DIMENSIONS



<b>ABSOLUTE MAXIMUM RATINGS</b> ( $T_A = 25^\circ\text{C}$ unless otherwise specified)			
Parameter	Symbol	Value	Units
<b>TOTAL PACKAGE</b>			
Storage Temperature	$T_{STG}$	-40 to +125	$^\circ\text{C}$
Junction Temperature	$T_J$	125	$^\circ\text{C}$
Operating Temperature	$T_{OPR}$	-40 to +85	$^\circ\text{C}$
<b>EMITTER</b>			
Continuous Forward Current	$I_F$ (avg)	60	mA
Peak Forward Current (1 $\mu\text{s}$ pulse, 300 pps.)	$I_F$ (pk)	1	A
Reverse Input Voltage	$V_R$	3	V
Power Dissipation (No derating required over operating temp. range)	$P_D$	100	mW
<b>DETECTOR</b>			
On-State RMS Current	$I_T$ (RMS)	70	mA (RMS)
Off-State Output Terminal Voltage	$V_{DRM}$	FODM3010/1/2	250
		FODM3021/2/3	400
Power Dissipation (No derating required over operating temp. range)	$P_D$	300	mW



**FODM3010    FODM3011    FODM3012    FODM3021    FODM3022    FODM3023**

<b>ELECTRICAL CHARACTERISTICS</b> ( $T_A = 25^\circ\text{C}$ )							
<b>INDIVIDUAL COMPONENT CHARACTERISTICS</b>							
Parameter	Test Conditions	Symbol	Device	Min	Typ*	Max	Unit
<b>EMITTER</b>							
Input Forward Voltage	$I_F = 10 \text{ mA}$	$V_F$	All		1.20	1.5	V
Reverse Leakage Current	$V_R = 3 \text{ V}, T_A = 25^\circ\text{C}$	$I_R$	All		0.01	100	$\mu\text{A}$
<b>DETECTOR</b>							
Peak Blocking Current Either Direction	Rated $V_{\text{DRM}}, I_F = 0$ (note 1)	$I_{\text{DRM}}$	All		2	100	nA
Peak On-State Voltage Either Direction	$I_{\text{TM}} = 100\text{mA peak}$	$V_{\text{TM}}$	All		1.7	3	V
Critical Rate of Rise of Off-State Voltage	$I_F = 0$ (Figure 8, note 2)	$dV/dt$	All		10		$\text{V}/\mu\text{s}$

<b>TRANSFER CHARACTERISTICS</b> ( $T_A = 25^\circ\text{C}$ )							
DC Characteristics	Test Conditions	Symbol	Device	Min	Typ*	Max	Unit
LED Trigger Current	Main Terminal Voltage = 3V (note 3)	$I_{\text{FT}}$	FODM3010			15	mA
			FODM3021				
			FODM3011			10	
			FODM3022				
			FODM3012			5	
			FODM3023				
Holding Current, Either Direction		$I_H$	All		300		$\mu\text{A}$

<b>ISOLATION CHARACTERISTICS</b>							
Characteristic	Test Conditions	Symbol	Device	Min	Typ*	Max	Unit
Steady State Isolation Voltage	(1 Minute)	$V_{\text{ISO}}$	All	3750			VRMS

\* All typicals at  $T_A = 25^\circ\text{C}$

**Note**

1. Test voltage must be applied within  $dv/dt$  rating.
2. This is static  $dv/dt$ . See Figure 1 for test circuit Commutating  $dv/dt$  is function of the load-driving thyristor(s) only.
3. All devices are guaranteed to trigger at an  $I_F$  value less than or equal to max  $I_{\text{FT}}$ . Therefore, recommended operating  $I_F$  lies between max  $I_{\text{FT}}$  (15 mA for FODM3010 and FODM3021, 10 mA for FODM3011 and FODM3022, 5 mA for FODM3012 and FODM3023) and absolute max  $I_F$  (60 mA).

**TYPICAL PERFORMANCE CURVES**

Fig. 1 LED Forward Voltage vs. Forward Current

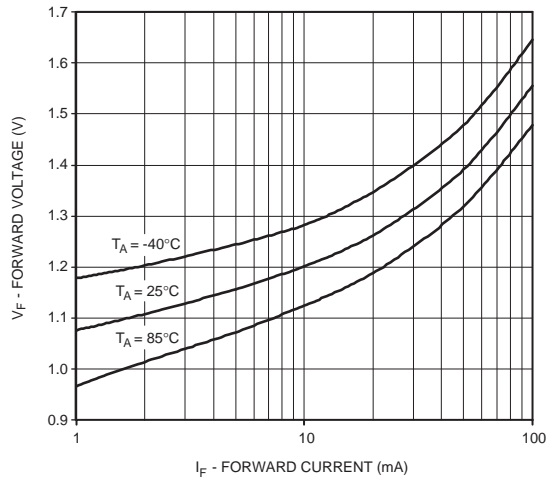


Fig. 2 Leakage Current vs. Ambient Temperature

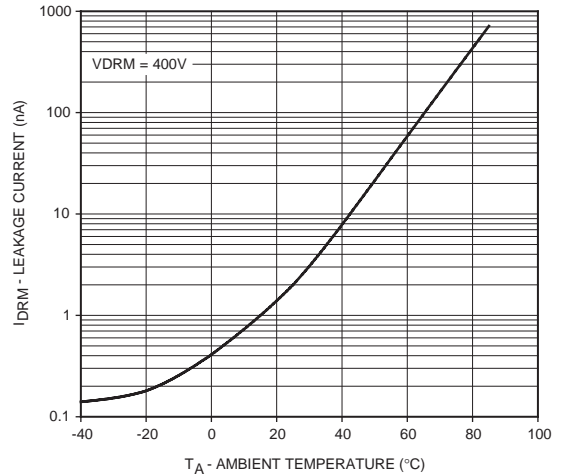


Fig. 3 Holding Current vs. Ambient Temperature

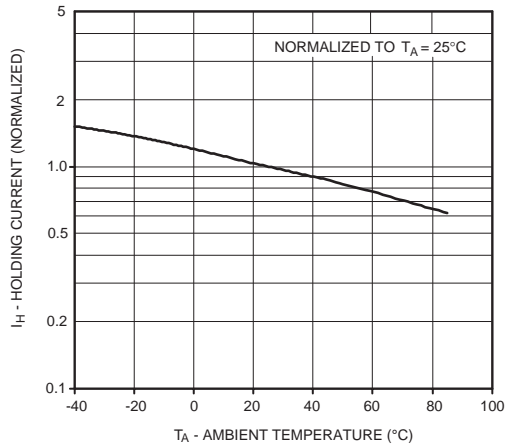
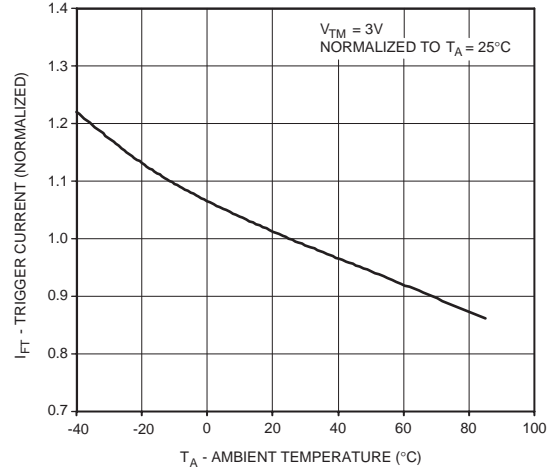
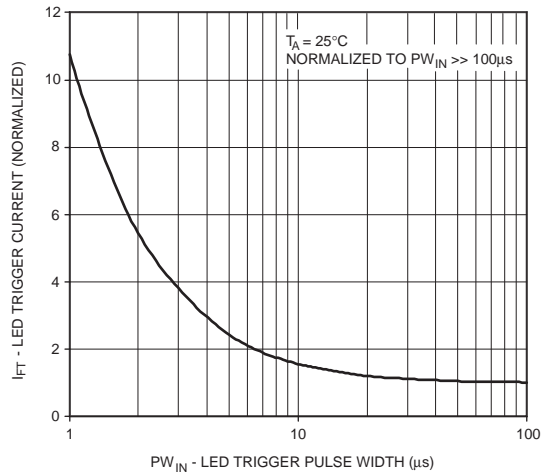


Fig. 4 Trigger Current vs. Ambient Temperature

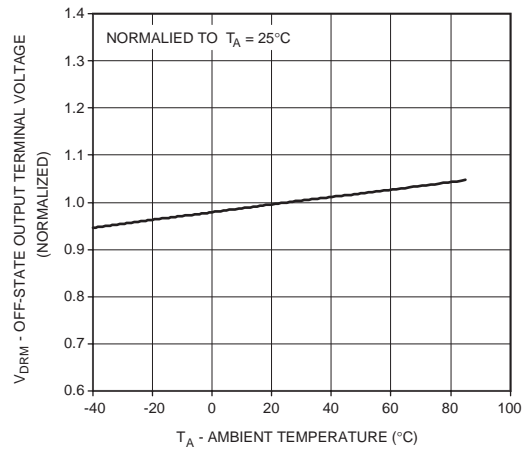


**TYPICAL PERFORMANCE CURVES**

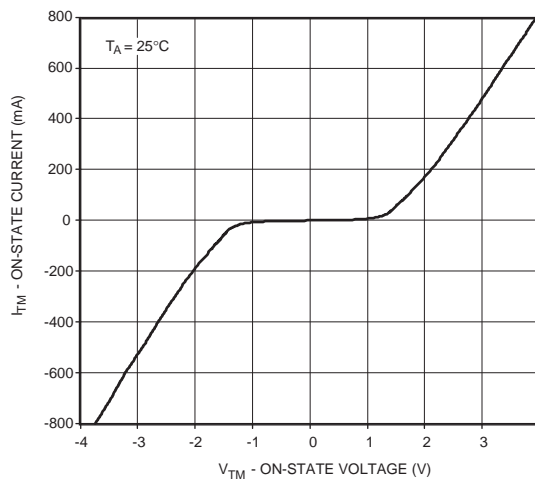
**Fig. 5 LED Current Required to Trigger vs. LED Pulse Width**



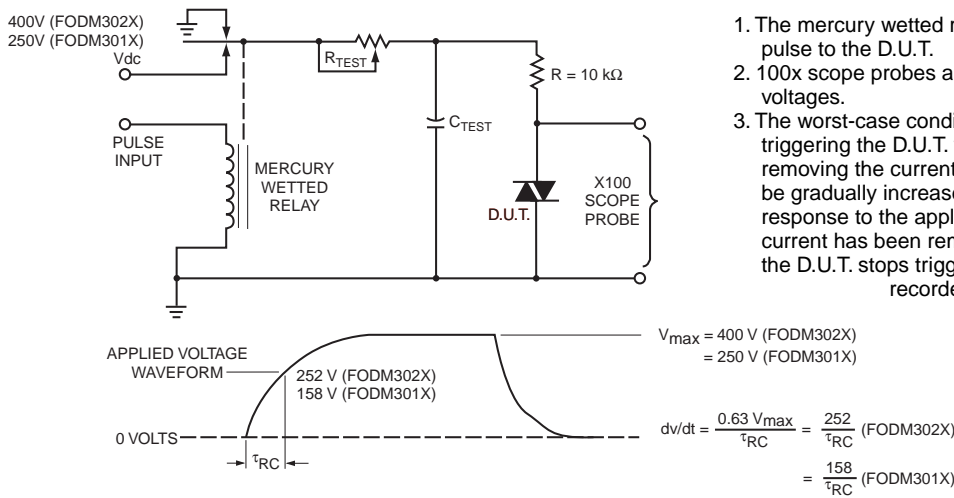
**Fig. 6 Off-state Output Terminal Voltage vs. Ambient Temperature**



**Fig. 7 On-State Characteristics**



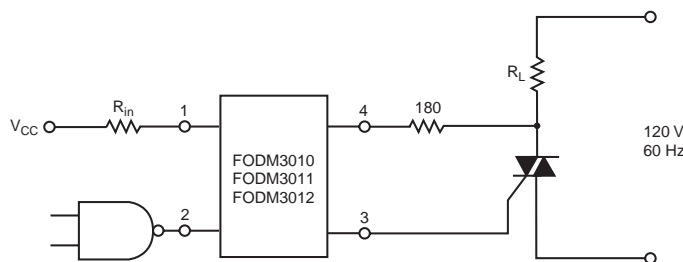
**TYPICAL PERFORMANCE CURVES**



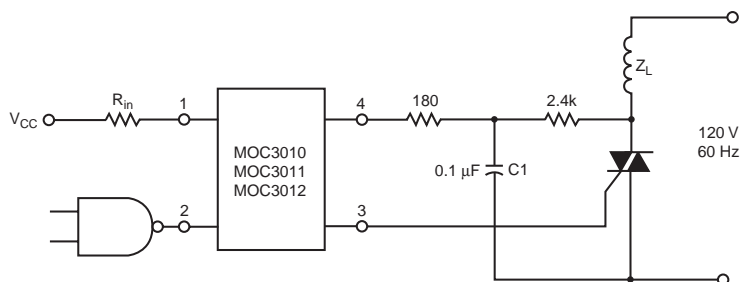
1. The mercury wetted relay provides a high speed repeated pulse to the D.U.T.
2. 100x scope probes are used, to allow high speeds and voltages.
3. The worst-case condition for static dv/dt is established by triggering the D.U.T. with a normal LED input current, then removing the current. The variable R<sub>TEST</sub> allows the dv/dt to be gradually increased until the D.U.T. continues to trigger in response to the applied voltage pulse, even after the LED current has been removed. The dv/dt is then decreased until the D.U.T. stops triggering. τ<sub>RC</sub> is measured at this point and recorded.

**Figure 8. Static dv/dt Test Circuit**

**NOTE:** This optoisolator should not be used to drive a load directly. It is intended to be a trigger device only.

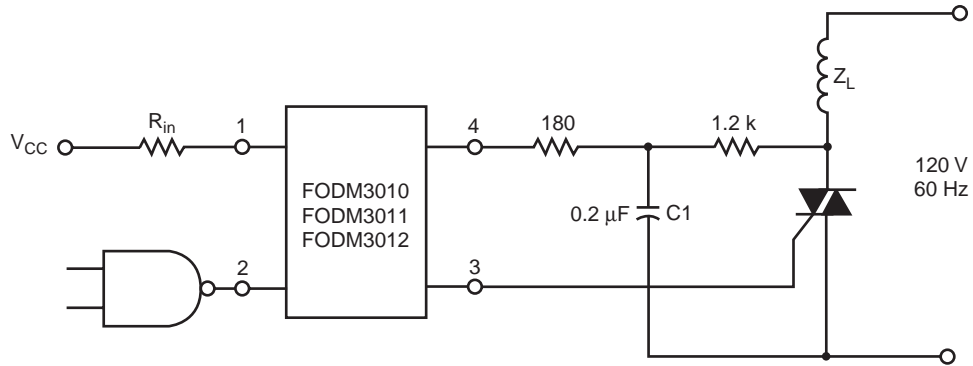


**Figure 9. Resistive Load**

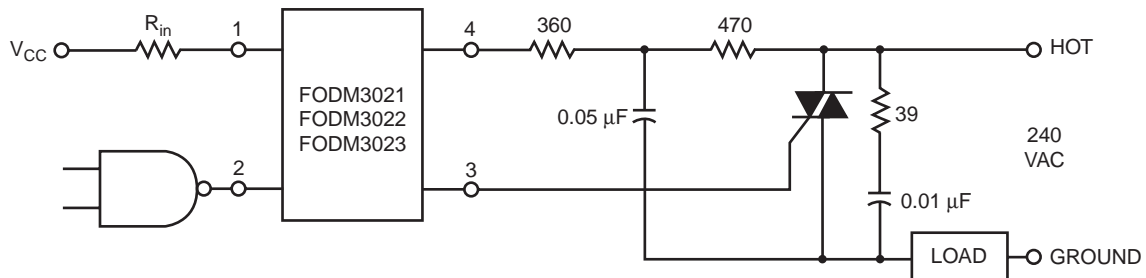


**Figure 10. Inductive Load with Sensitive Gate Triac (I<sub>GT</sub> ≤ 15 mA)**

**FODM3010    FODM3011    FODM3012    FODM3021    FODM3022    FODM3023**



**Figure 11. Inductive Load with Sensitive Gate Triac ( $I_{GT} \leq 15 \text{ mA}$ )**



In this circuit the "hot" side of the line is switched and the load connected to the cold or ground side.

The 39 ohm resistor and 0.01  $\mu\text{F}$  capacitor are for snubbing of the triac, and the 470 ohm resistor and 0.05  $\mu\text{F}$  capacitor are for snubbing the coupler. These components may or may not be necessary depending upon the particular and load used.

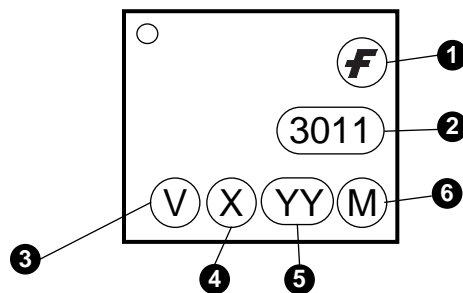
**Figure 12. Typical Application Circuit**

**FODM3010    FODM3011    FODM3012    FODM3021    FODM3022    FODM3023**

**ORDERING INFORMATION**

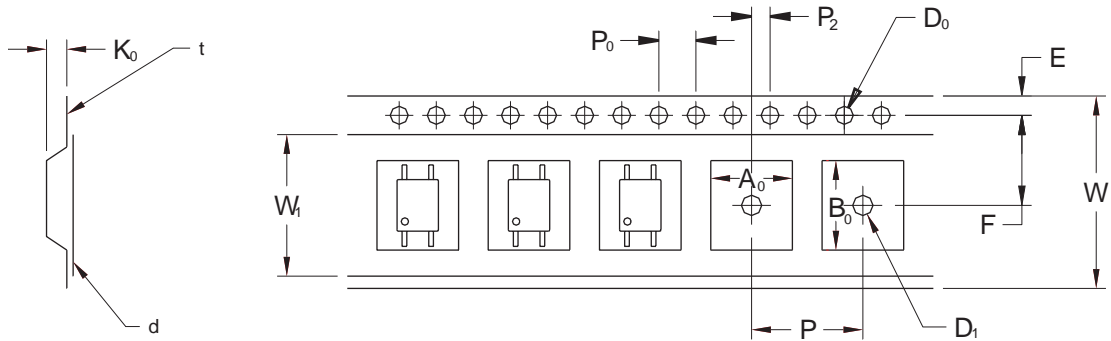
Option	Description
V	VDE Approved
R1	Tape and Reel (500 units)
R2	Tape and Reel (2500 units)
R3	Tape and Reel (500 units; unit 180° rotated)
R4	Tape and Reel (2500 units; unit 180° rotated)
R1V	Tape and Reel (500 units) and VDE Approved
R2V	Tape and Reel (2500 units) and VDE Approved
R3V	Tape and Reel (500 units; unit 180° rotated) and VDE Approved
R4V	Tape and Reel (2500 units; unit 180° rotated) and VDE Approved

**MARKING INFORMATION**



Definitions	
1	Fairchild logo
2	Device number
3	VDE mark (Note: Only appears on parts ordered with VDE option – See order entry table)
4	One digit year code
5	Two digit work week ranging from '01' to '53'
6	Assembly package code

**FODM3010    FODM3011    FODM3012    FODM3021    FODM3022    FODM3023**



Description		Symbol	2.54 Pitch
			Dimensions (mm)
Tape Width		W	12.00±0.4
Tape Thickness		t	0.30±0.20
Sprocket Hole Pitch		P <sub>0</sub>	4.00±0.20
Sprocket Hole Dia.		D <sub>0</sub>	1.55±0.20
Sprocket Hole Location		E	1.75±0.20
Pocket Location		F	5.50±0.20
		P <sub>2</sub>	2.00±0.20
Pocket Pitch		P	8.00±0.20
Pocket Dimension		A <sub>0</sub>	4.40±0.20
		B <sub>0</sub>	7.30±0.20
		K <sub>0</sub>	2.30±0.20
Pocket Hole Dia.		D <sub>1</sub>	1.55±0.20
Cover Tape Width		W <sub>1</sub>	9.20
Cover Tape Thickness		d	0.065±0.02
Max. Component Rotation or Tilt			20° max
Devices Per Reel		R1	500
		R2	2500
Reel Diameter		R1	178 mm (7")
		R2	330 mm (13")



FODM3010

FODM3011

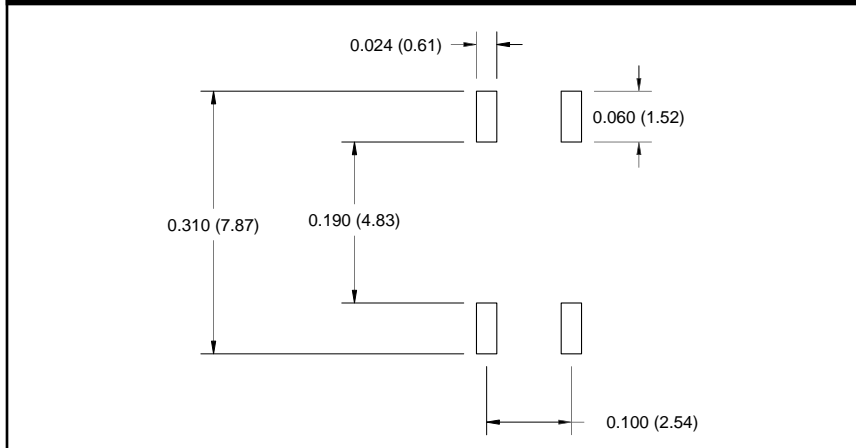
FODM3012

FODM3021

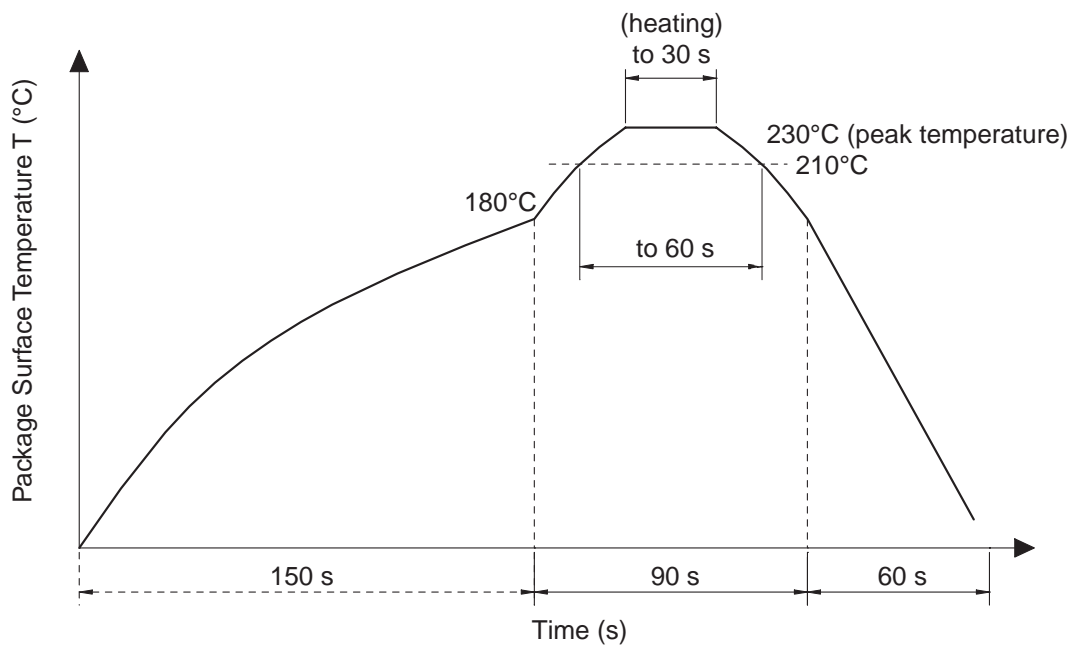
FODM3022

FODM3023

**Footprint Drawing for PCB Layout**



**Recommended Infrared Reflow Soldering Profile**



- Peak reflow temperature: 230°C (package surface temperature) for 30 seconds
- Time of temperature higher than 210°C: 60 seconds or less
- One time soldering reflow is recommended

---

**FODM3010**

**FODM3011**

**FODM3012**

**FODM3021**

**FODM3022**

**FODM3023**

---

**DISCLAIMER**

FAIRCHILD SEMICONDUCTOR RESERVES THE RIGHT TO MAKE CHANGES WITHOUT FURTHER NOTICE TO ANY PRODUCTS HEREIN TO IMPROVE RELIABILITY, FUNCTION OR DESIGN. FAIRCHILD DOES NOT ASSUME ANY LIABILITY ARISING OUT OF THE APPLICATION OR USE OF ANY PRODUCT OR CIRCUIT DESCRIBED HEREIN; NEITHER DOES IT CONVEY ANY LICENSE UNDER ITS PATENT RIGHTS, NOR THE RIGHTS OF OTHERS.

**LIFE SUPPORT POLICY**

FAIRCHILD'S PRODUCTS ARE NOT AUTHORIZED FOR USE AS CRITICAL COMPONENTS IN LIFE SUPPORT DEVICES OR SYSTEMS WITHOUT THE EXPRESS WRITTEN APPROVAL OF THE PRESIDENT OF FAIRCHILD SEMICONDUCTOR CORPORATION. As used herein:

1. Life support devices or systems are devices or systems which, (a) are intended for surgical implant into the body, or (b) support or sustain life, and (c) whose failure to perform when properly used in accordance with instructions for use provided in the labeling, can be reasonably expected to result in a significant injury of the user.
2. A critical component in any component of a life support device or system whose failure to perform can be reasonably expected to cause the failure of the life support device or system, or to affect its safety or effectiveness.