



FP402

N-Channel MOS Silicon FET Very High-Speed Switching Applications

Features

- Low ON resistance.
- Very high-speed switching.
- Complex type with 2 low-voltage-drive N-channel MOSFETs facilitating high-density mounting.

Electrical Connection

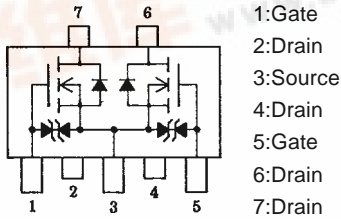

- 1: Gate
- 2: Drain
- 3: Source
- 4: Drain
- 5: Gate
- 6: Drain
- 7: Drain

(Top view)

Package Dimensions

unit:mm

2102A

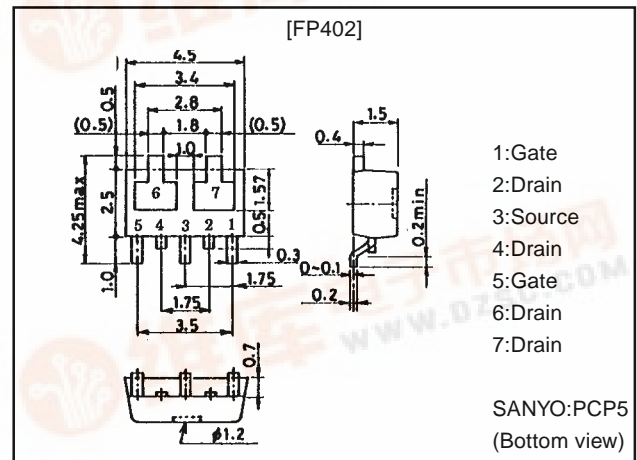

- 1: Gate
- 2: Drain
- 3: Source
- 4: Drain
- 5: Gate
- 6: Drain
- 7: Drain

SANYO:PCP5
(Bottom view)

Specifications

Absolute Maximum Ratings at Ta = 25°C

Parameter	Symbol	Conditions	Ratings	Unit
Drain-to-Source Voltage	V_{DSS}		20	V
Gate-to-Source Voltage	V_{GSS}		± 15	V
Drain Current (DC)	I_D		1	A
Drain Current (Pulse)	I_{DP}	$PW \leq 10\mu s$, duty cycle $\leq 1\%$	4	A
Allowable Power Dissipation	P_D	$T_c = 25^\circ C$, 1 unit	2.0	W
	P_D	Mounted on ceramic board (250mm \times 0.8mm) 1 unit	0.8	W
Total Power Dissipation	P_T	Mounted on ceramic board (250mm \times 0.8mm)	1.1	W
Channel Temperature	T_{ch}		150	$^\circ C$
Storage Temperature	T_{stg}		-55 to +150	$^\circ C$

Electrical Characteristics at Ta=25°C

Parameter	Symbol	Conditions	Ratings			Unit
			min	typ	max	
D-S Breakdown Voltage	$V_{(BR)DSS}$	$I_D = 1mA$, $V_{GS} = 0$	20			V
Zero Gate Voltage Drain Current	I_{DSS}	$V_{DS} = 20V$, $V_{GS} = 0$			100	μA
Gate-to-Source Leakage Current	I_{GSS}	$V_{GS} = \pm 12V$, $V_{DS} = 0$			± 10	μA
Cutoff Voltage	$V_{GSS(off)}$	$V_{DS} = 10V$, $I_D = 1mA$	0.8		2.0	V
Forward Transfer Admittance	$ Y_{fs} $	$V_{DS} = 10V$, $I_D = 500mA$	0.6	1.0		S
Static Drain-to-Source ON-State Resistance	$R_{DS(on)}$	$I_D = 500mA$, $V_{GS} = 10V$		350	480	$m\Omega$
	$R_{DS(on)}$	$I_D = 500mA$, $V_{GS} = 4V$		550	750	$m\Omega$
Input Capacitance	C_{iss}	$V_{DS} = 10V$, $f = 1MHz$		50		pF
Output Capacitance	C_{oss}	$V_{DS} = 10V$, $f = 1MHz$		45		pF
Reverse Transfer Capacitance	C_{rss}	$V_{DS} = 10V$, $f = 1MHz$		15		pF
Turn-ON Delay Time	$t_{d(on)}$	See specified Test Circuit		8		ns
Rise Time	t_r	See specified Test Circuit		10		ns
Turn-OFF Delay Time	$t_{d(off)}$	See specified Test Circuit		30		ns
Fall Time	t_f	See specified Test Circuit		20		ns
Diode Forward Voltage	V_{SD}	$I_S = 1A$, $V_{GS} = 0$		1.0		V



FP402

Switching Time Test Circuit

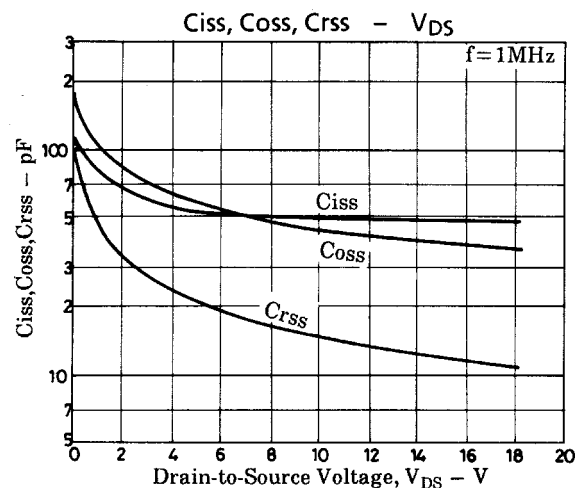
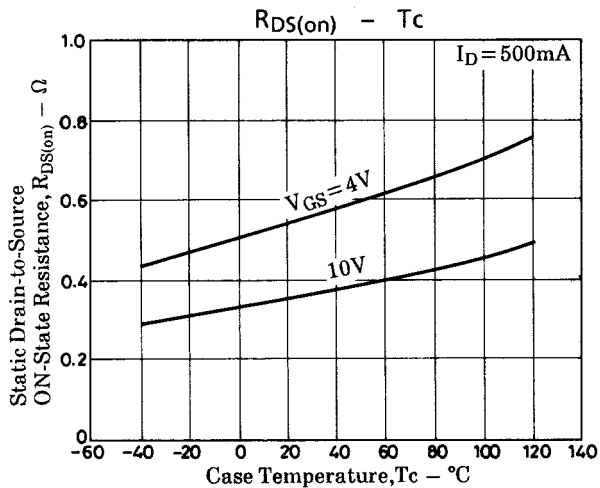
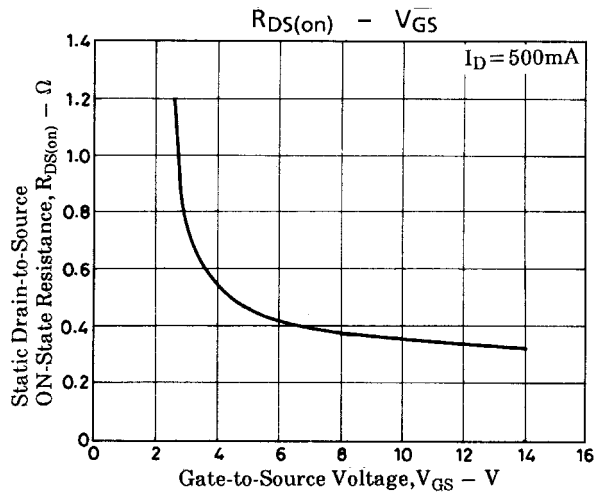
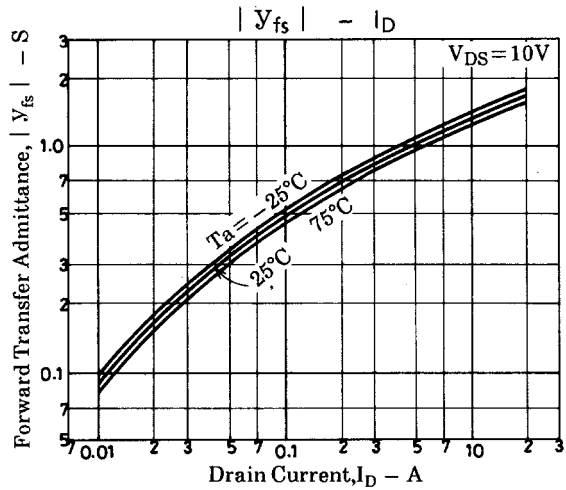
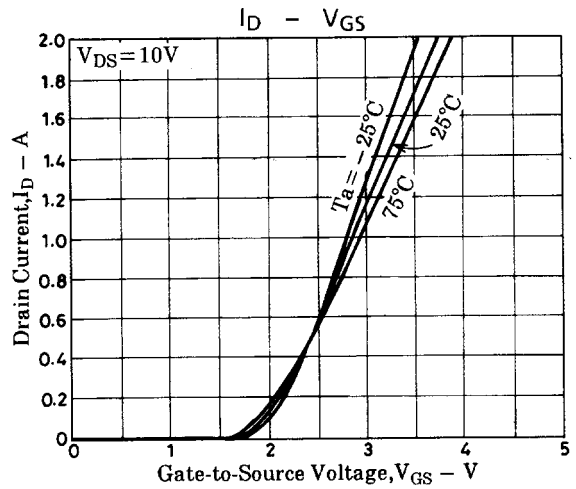
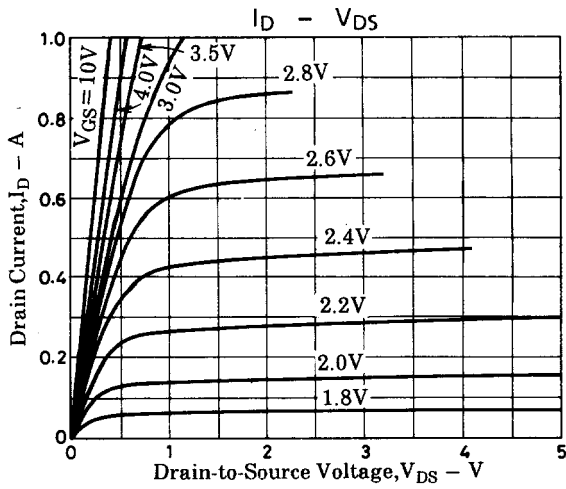
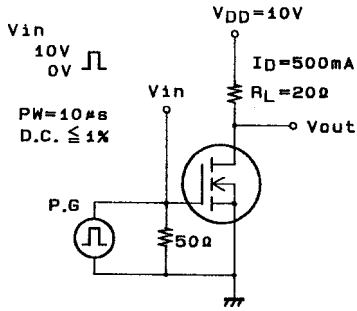

FP402

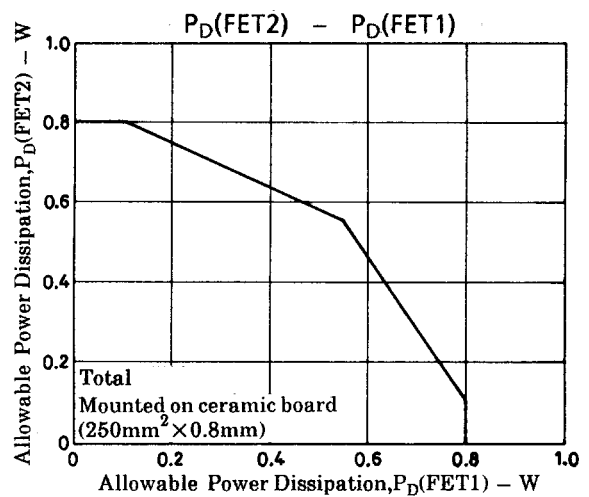
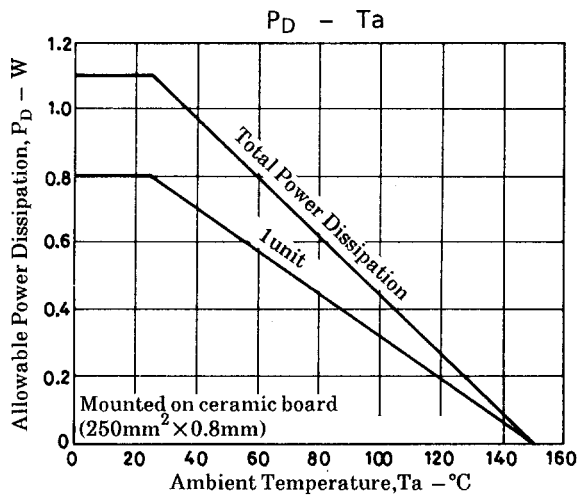
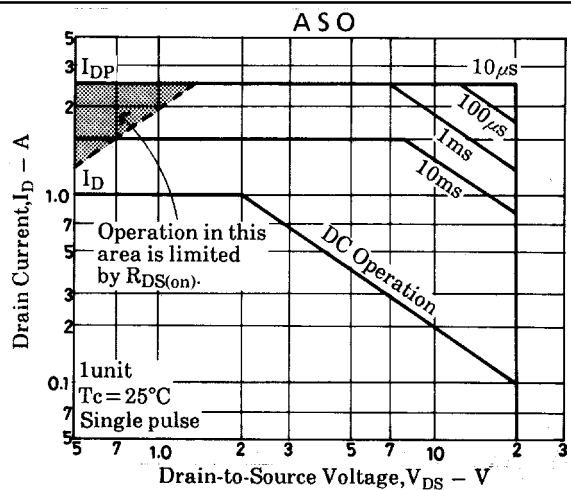
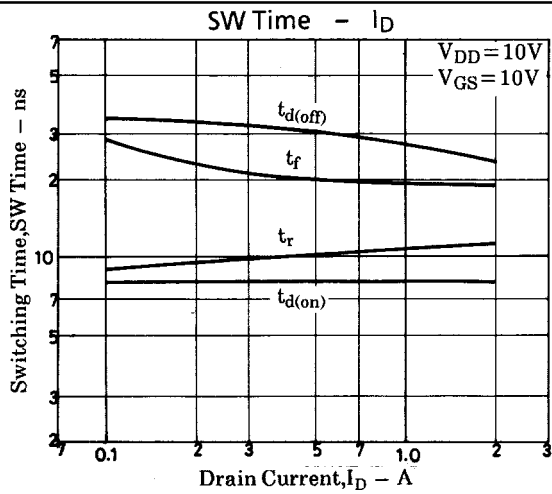

■ No products described or contained herein are intended for use in surgical implants, life-support systems, aerospace equipment, nuclear power control systems, vehicles, disaster/crime-prevention equipment and the like, the failure of which may directly or indirectly cause injury, death or property loss.

■ Anyone purchasing any products described or contained herein for an above-mentioned use shall:

- ① Accept full responsibility and indemnify and defend SANYO ELECTRIC CO., LTD., its affiliates, subsidiaries and distributors and all their officers and employees, jointly and severally, against any and all claims and litigation and all damages, cost and expenses associated with such use:
- ② Not impose any responsibility for any fault or negligence which may be cited in any such claim or litigation on SANYO ELECTRIC CO., LTD., its affiliates, subsidiaries and distributors or any of their officers and employees jointly or severally.

■ Information (including circuit diagrams and circuit parameters) herein is for example only; it is not guaranteed for volume production. SANYO believes information herein is accurate and reliable, but no guarantees are made or implied regarding its use or any infringements of intellectual property rights or other rights of third parties.