

**PRELIMINARY**  
 Notice: This is not a final specification.  
 Some parametric limits are subject to change.

MITSUBISHI Nch POWER MOSFET

# FS10UMA-4A

HIGH-SPEED SWITCHING USE

## FS10UMA-4A

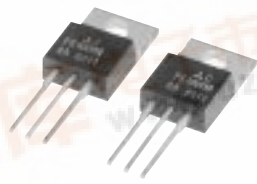

- 10V DRIVE
- V<sub>DSS</sub> ..... 200V
- r<sub>D(S)</sub> (ON) (MAX) ..... 0.52Ω
- I<sub>D</sub> ..... 10A

## OUTLINE DRAWING

Dimensions in mm

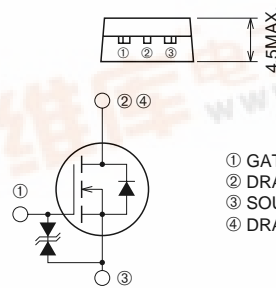
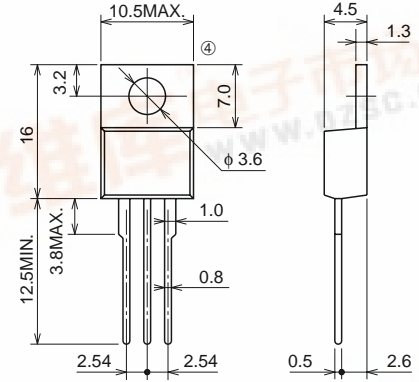

TO-220

## APPLICATION

Cs Switch for CRT Display monitor, Switch mode power supply, etc.

## MAXIMUM RATINGS (T<sub>c</sub> = 25°C)

Symbol	Parameter	Conditions	Ratings	Unit
V <sub>DSS</sub>	Drain-source voltage	V <sub>GS</sub> = 0V	200	V
V <sub>GSS</sub>	Gate-source voltage	V <sub>DS</sub> = 0V	±20	V
I <sub>D</sub>	Drain current		10	A
I <sub>DM</sub>	Drain current (Pulsed)		30	A
I <sub>DA</sub>	Avalanche drain current (Pulsed)	L = 200μH	10	A
P <sub>D</sub>	Maximum power dissipation		45	W
T <sub>ch</sub>	Channel temperature		-55 ~ +150	°C
T <sub>stg</sub>	Storage temperature		-55 ~ +150	°C
—	Weight	Typical value	2.0	g



**FS10UMA-4A**

**HIGH-SPEED SWITCHING USE**

**PRELIMINARY**  
 Notice: This is not a final specification.  
 Some parametric limits are subject to change.

**ELECTRICAL CHARACTERISTICS** (Tch = 25°C)

Symbol	Parameter	Test conditions	Limits			Unit
			Min.	Typ.	Max.	
V(BR)DSS	Drain-source breakdown voltage	Id = 1mA, VGS = 0V	200	—	—	V
V(BR)GSS	Gate-source breakdown voltage	IGS = ±10μA, VDS = 0V	±20	—	—	V
IGSS	Gate-source leakage current	VGS = ±20V, VDS = 0V	—	—	±10	μA
IDSS	Drain-source leakage current	VDS = 200V, VGS = 0V	—	—	1	mA
VGS(th)	Gate-source threshold voltage	Id = 1mA, VDS = 10V	2.0	3.0	4.0	V
rDS(ON)	Drain-source on-state resistance	Id = 5A, VGS = 10V	—	0.40	0.52	Ω
VDS(ON)	Drain-source on-state voltage	Id = 5A, VGS = 10V	—	2.00	2.60	V
yfs	Forward transfer admittance	Id = 5A, VDS = 10V	—	7.0	—	S
Ciss	Input capacitance	VDS = 25V, VGS = 0V, f = 1MHz	—	650	—	pF
Coss	Output capacitance		—	80	—	pF
Crss	Reverse transfer capacitance		—	25	—	pF
td(on)	Turn-on delay time	VDD = 100V, Id = 5A, VGS = 10V, RGEN = RGS = 50Ω	—	15	—	ns
tr	Rise time		—	20	—	ns
td(off)	Turn-off delay time		—	80	—	ns
tf	Fall time		—	25	—	ns
VSD	Source-drain voltage	Is = 5A, VGS = 0V	—	0.95	—	V
Rth(ch-c)	Thermal resistance	Channel to case	—	—	2.78	°C/W

**PERFORMANCE CURVES**

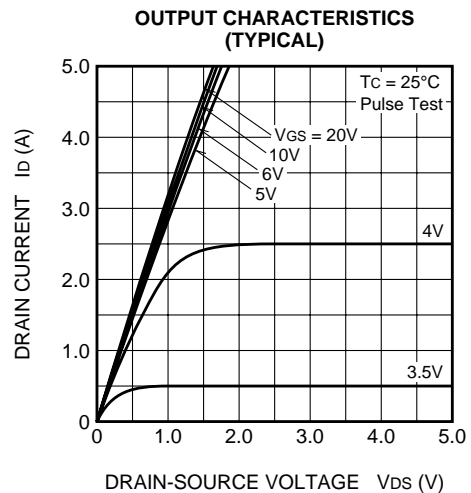
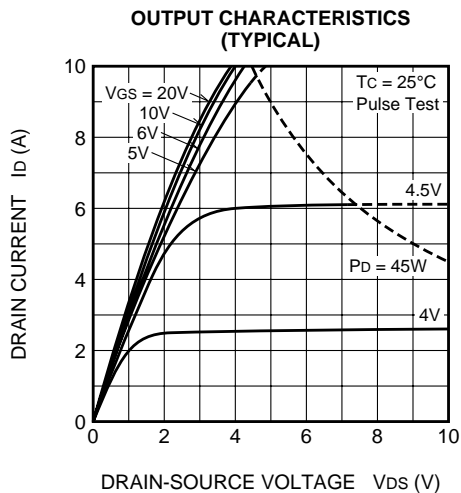
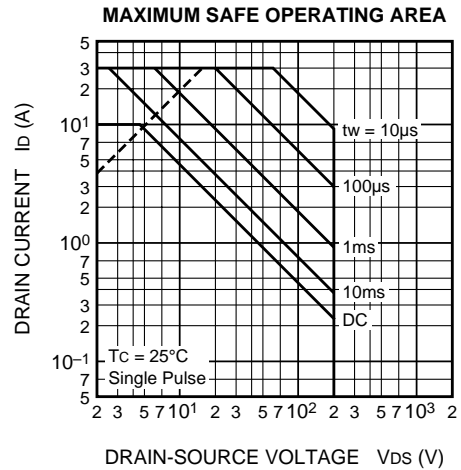
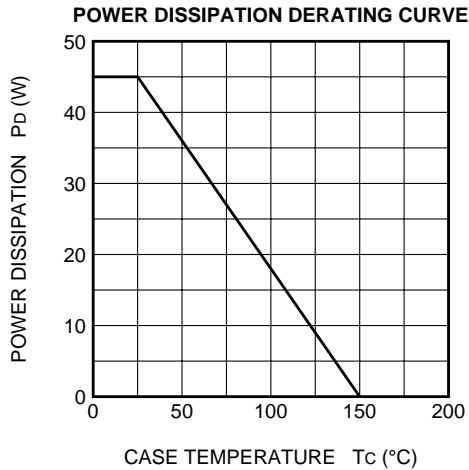

**PRELIMINARY**  
 Notice: This is not a final specification.  
 Some parametric limits are subject to change.

MITSUBISHI Nch POWER MOSFET

**FS10UMA-4A**

**HIGH-SPEED SWITCHING USE**

**ON-STATE VOLTAGE VS. GATE-SOURCE VOLTAGE (TYPICAL)**

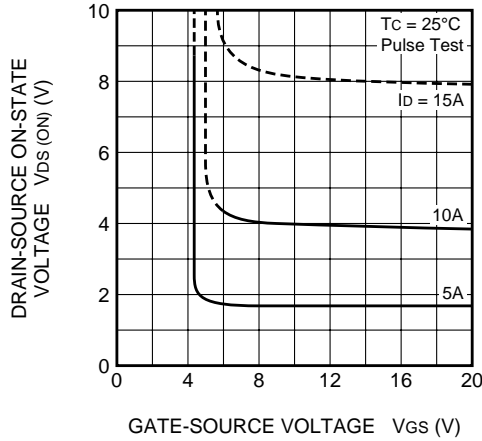

**ON-STATE RESISTANCE VS. DRAIN CURRENT (TYPICAL)**

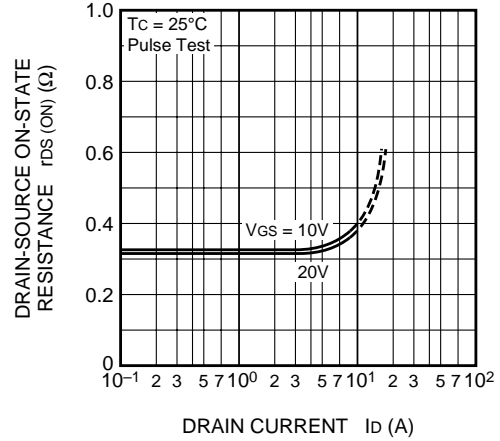

**TRANSFER CHARACTERISTICS (TYPICAL)**

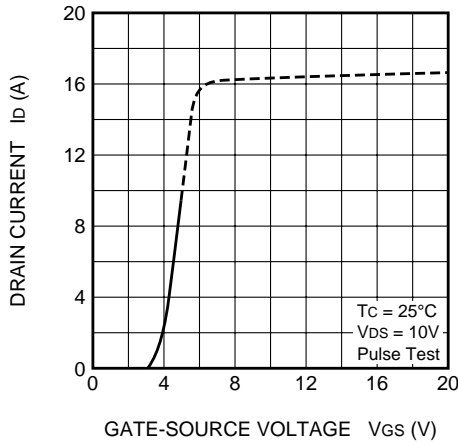

**FORWARD TRANSFER ADMITTANCE VS. DRAIN CURRENT (TYPICAL)**

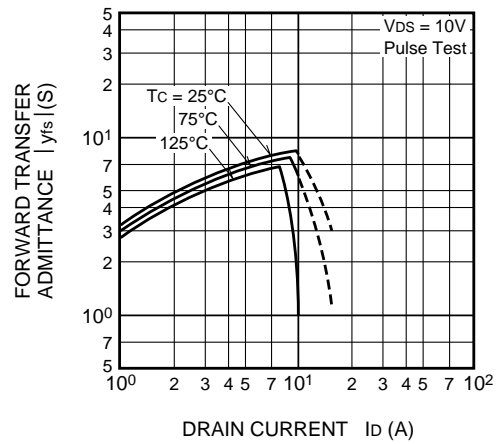

**CAPACITANCE VS. DRAIN-SOURCE VOLTAGE (TYPICAL)**

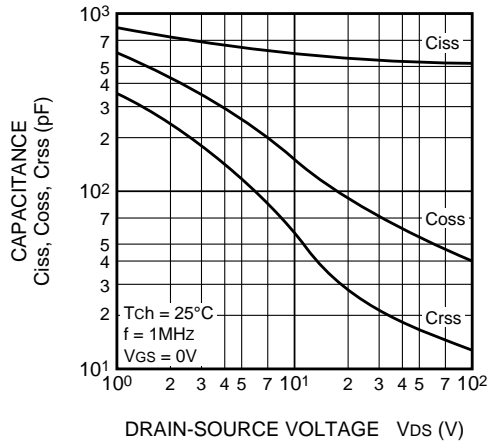

**SWITCHING CHARACTERISTICS (TYPICAL)**

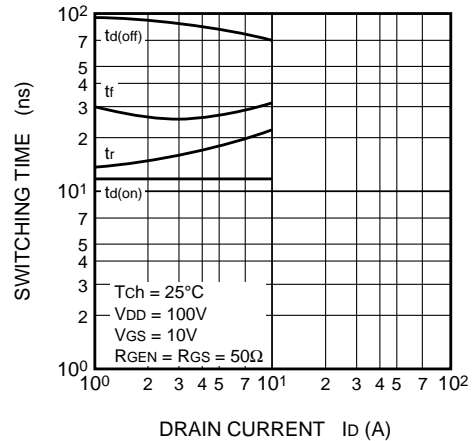

**PRELIMINARY**  
 Notice: This is not a final specification.  
 Some parametric limits are subject to change.

**GATE-SOURCE VOLTAGE VS. GATE CHARGE (TYPICAL)**

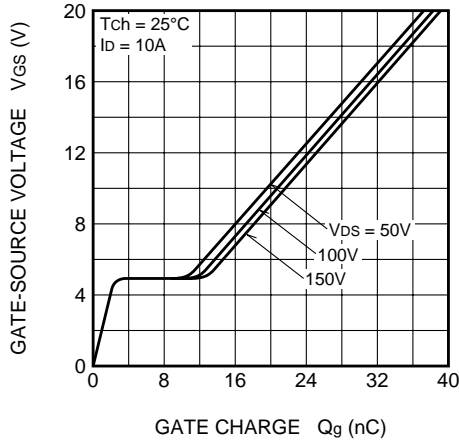

**SOURCE-DRAIN DIODE FORWARD CHARACTERISTICS (TYPICAL)**

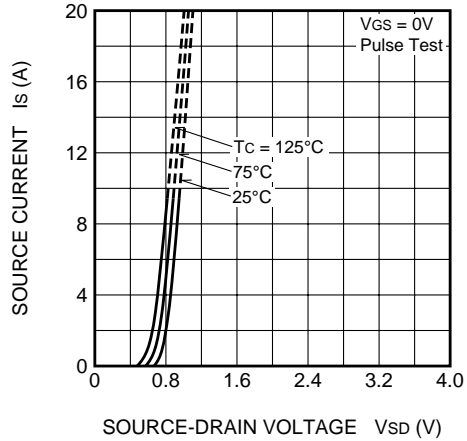

**ON-STATE RESISTANCE VS. CHANNEL TEMPERATURE (TYPICAL)**

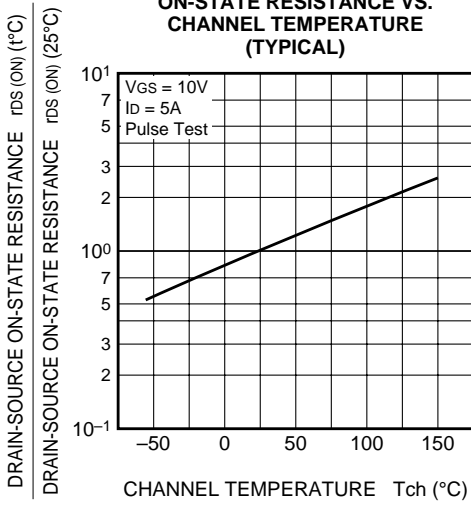

**THRESHOLD VOLTAGE VS. CHANNEL TEMPERATURE (TYPICAL)**

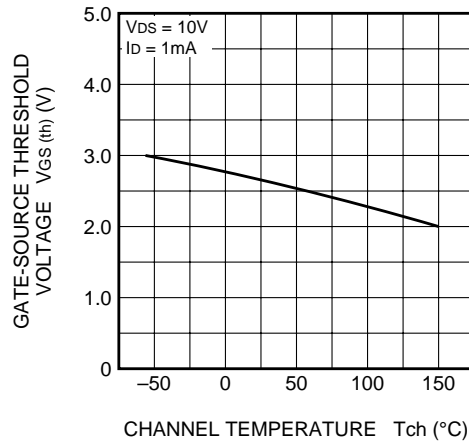

**BREAKDOWN VOLTAGE VS. CHANNEL TEMPERATURE (TYPICAL)**

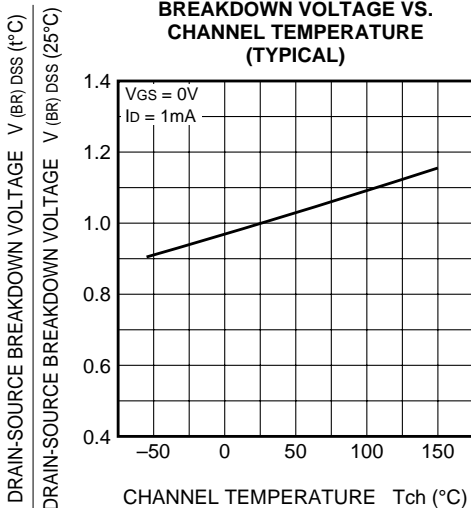

**TRANSIENT THERMAL IMPEDANCE CHARACTERISTICS**

