

MITSUBISHI Nch POWER MOSFET

FS12KMA-4A

HIGH-SPEED SWITCHING USE

PRELIMINARY

Notice: This is not a final specification.
Some parametric limits are subject to change.

FS12KMA-4A

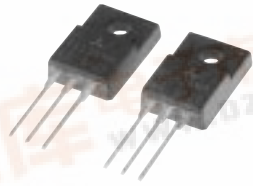

- 10V DRIVE
- V_{DSS} 200V
- r_{DS} (ON) (MAX) 0.40Ω
- I_D 12A

OUTLINE DRAWING

Dimensions in mm

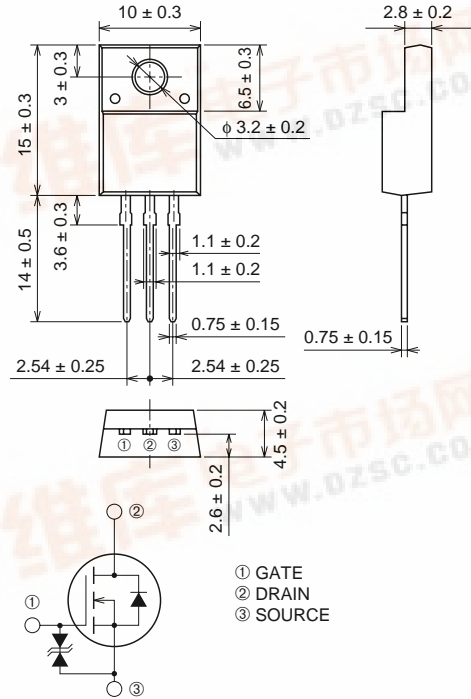

TO-220FN

APPLICATION

Cs Switch for CRT Display monitor, Switch mode power supply, etc.

MAXIMUM RATINGS (T_c = 25°C)

Symbol	Parameter	Conditions	Ratings	Unit
V _{DSS}	Drain-source voltage	V _{GS} = 0V	200	V
V _{GSS}	Gate-source voltage	V _{DS} = 0V	±20	V
I _D	Drain current		12	A
I _{DM}	Drain current (Pulsed)		36	A
I _{DA}	Avalanche drain current (Pulsed)	L = 200μH	12	A
P _D	Maximum power dissipation		32	W
T _{ch}	Channel temperature		-55 ~ +150	°C
T _{stg}	Storage temperature		-55 ~ +150	°C
V _{iso}	Isolation voltage	AC for 1minute, Terminal to case	2000	V
—	Weight	Typical value	2.0	g

FS12KMA-4A

HIGH-SPEED SWITCHING USE

PRELIMINARY
 Notice: This is not a final specification.
 Some parametric limits are subject to change.

ELECTRICAL CHARACTERISTICS (Tch = 25°C)

Symbol	Parameter	Test conditions	Limits			Unit
			Min.	Typ.	Max.	
V (BR) DSS	Drain-source breakdown voltage	Id = 1mA, VGS = 0V	200	—	—	V
V (BR) GSS	Gate-source breakdown voltage	IGS = ±10μA, VDS = 0V	±20	—	—	V
IGSS	Gate-source leakage current	VGS = ±20V, VDS = 0V	—	—	±10	μA
IDSS	Drain-source leakage current	VDS = 200V, VGS = 0V	—	—	1	mA
VGS (th)	Gate-source threshold voltage	Id = 1mA, VDS = 10V	2.0	3.0	4.0	V
rDS (ON)	Drain-source on-state resistance	Id = 6A, VGS = 10V	—	0.30	0.40	Ω
VDS (ON)	Drain-source on-state voltage	Id = 6A, VGS = 10V	—	1.80	2.40	V
yfs	Forward transfer admittance	Id = 6A, VDS = 10V	—	8.0	—	S
Ciss	Input capacitance	VDS = 25V, VGS = 0V, f = 1MHz	—	700	—	pF
Coss	Output capacitance		—	95	—	pF
Crss	Reverse transfer capacitance		—	30	—	pF
td (on)	Turn-on delay time	VDD = 100V, Id = 6A, VGS = 10V, RGEN = RGS = 50Ω	—	15	—	ns
tr	Rise time		—	20	—	ns
td (off)	Turn-off delay time		—	110	—	ns
tf	Fall time		—	35	—	ns
VSD	Source-drain voltage	Is = 6A, VGS = 0V	—	0.95	—	V
Rth (ch-c)	Thermal resistance	Channel to case	—	—	3.91	°C/W

PERFORMANCE CURVES

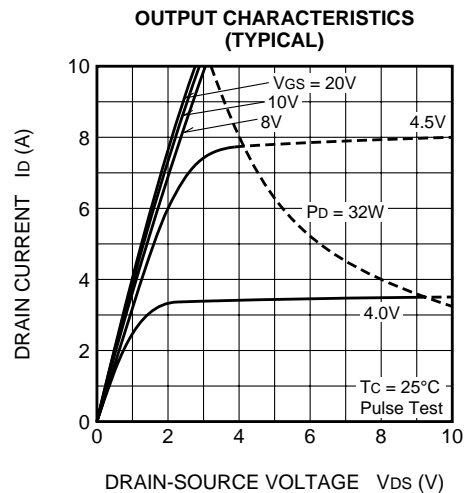
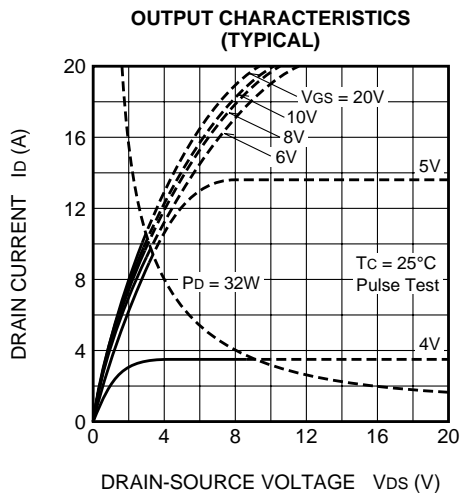
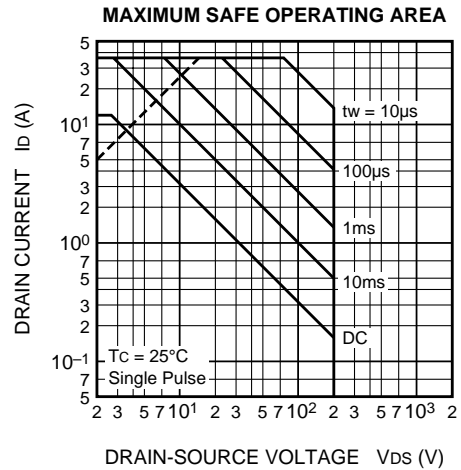
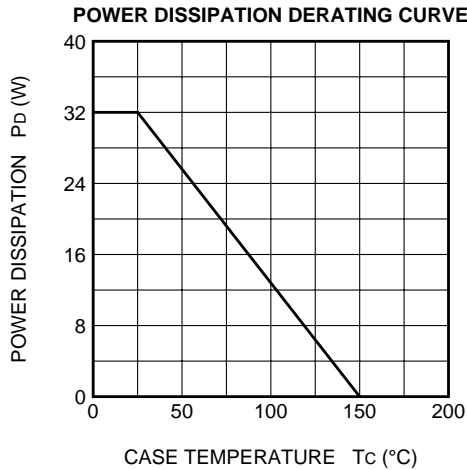

PRELIMINARY
 Notice: This is not a final specification.
 Some parametric limits are subject to change.

MITSUBISHI Nch POWER MOSFET

FS12KMA-4A

HIGH-SPEED SWITCHING USE

ON-STATE VOLTAGE VS. GATE-SOURCE VOLTAGE (TYPICAL)

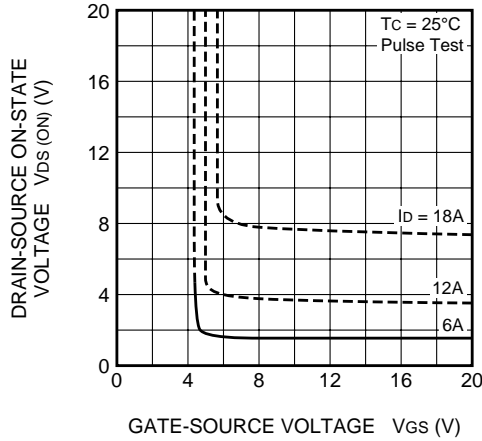

ON-STATE RESISTANCE VS. DRAIN CURRENT (TYPICAL)

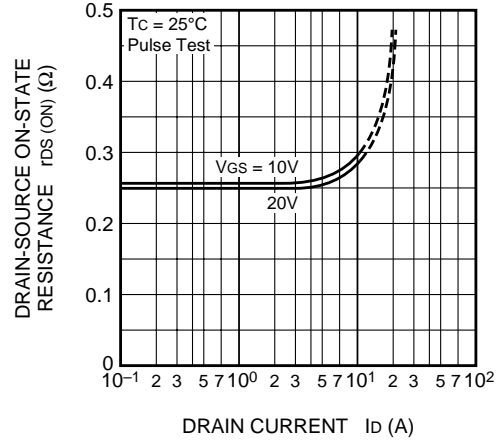

TRANSFER CHARACTERISTICS (TYPICAL)

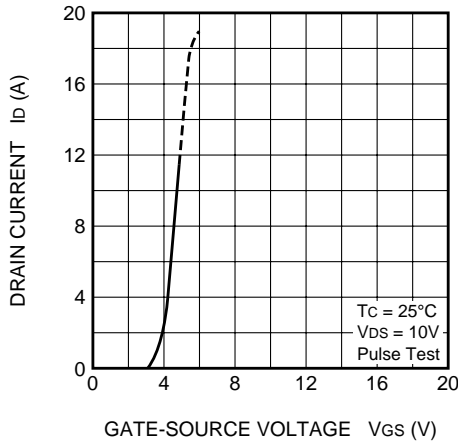

FORWARD TRANSFER ADMITTANCE VS. DRAIN CURRENT (TYPICAL)

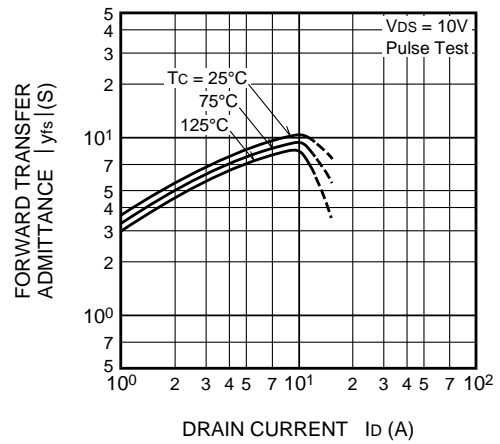

CAPACITANCE VS. DRAIN-SOURCE VOLTAGE (TYPICAL)

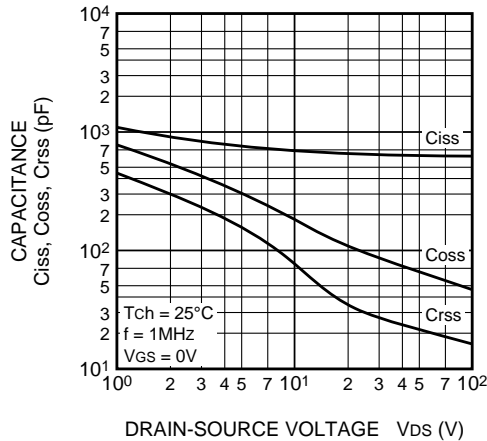

SWITCHING CHARACTERISTICS (TYPICAL)

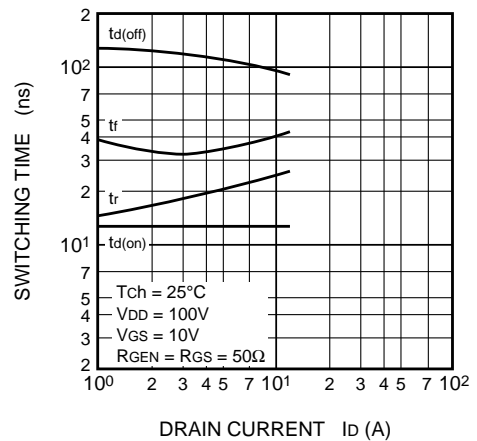

PRELIMINARY
 Notice: This is not a final specification.
 Some parametric limits are subject to change.

GATE-SOURCE VOLTAGE VS. GATE CHARGE (TYPICAL)

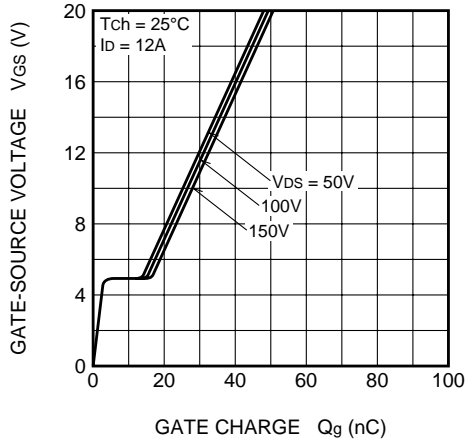

SOURCE-DRAIN DIODE FORWARD CHARACTERISTICS (TYPICAL)

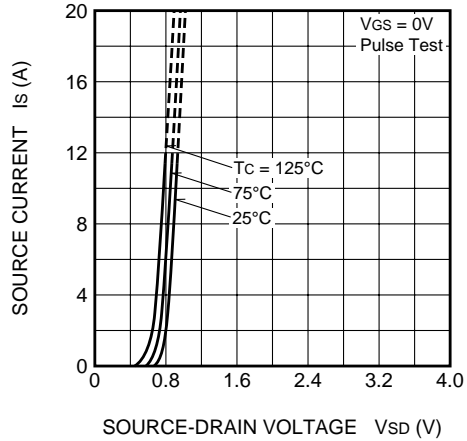

ON-STATE RESISTANCE VS. CHANNEL TEMPERATURE (TYPICAL)

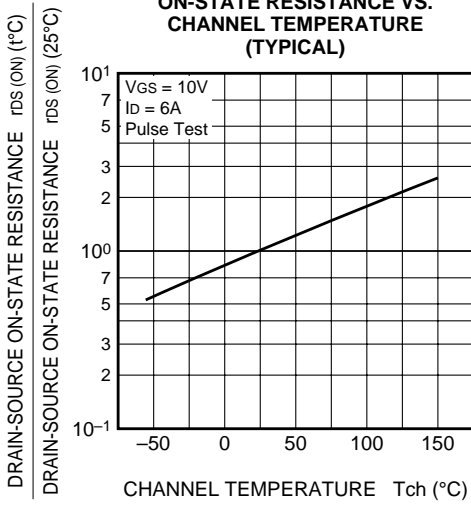

THRESHOLD VOLTAGE VS. CHANNEL TEMPERATURE (TYPICAL)

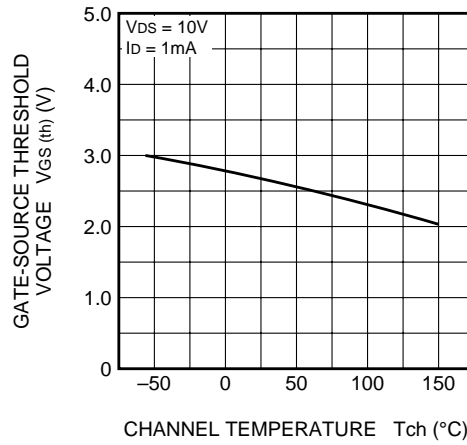

BREAKDOWN VOLTAGE VS. CHANNEL TEMPERATURE (TYPICAL)

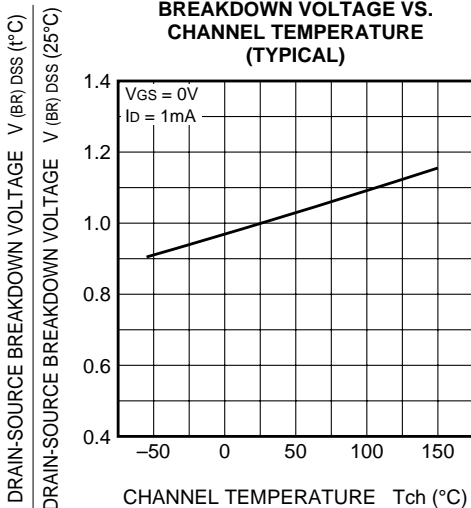

TRANSIENT THERMAL IMPEDANCE CHARACTERISTICS

