

MITSUBISHI Nch POWER MOSFET

FS16VS-5

HIGH-SPEED SWITCHING USE

FS16VS-5

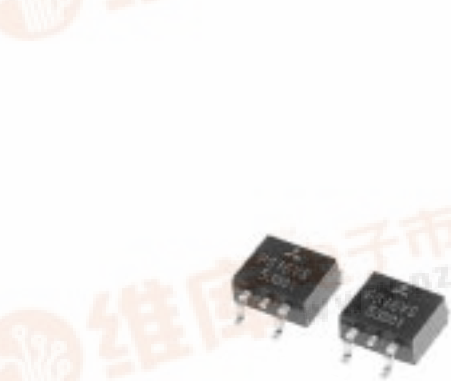

- V_{DSS} 250V
- r_{DS (ON)} (MAX) 0.25Ω
- I_D 16A

OUTLINE DRAWING

Dimensions in mm

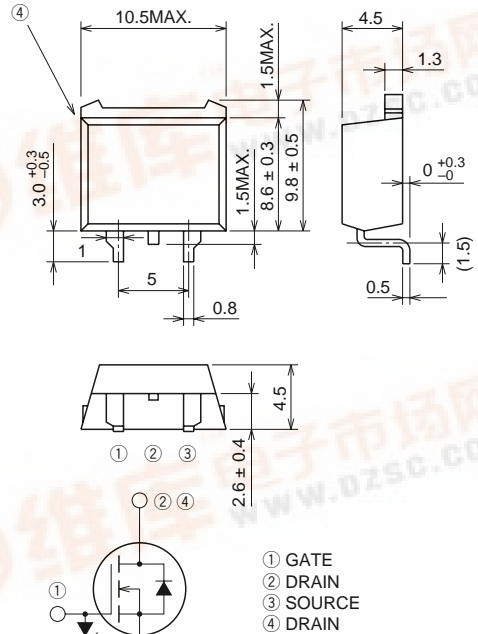

TO-220S

APPLICATION

SMPS, DC-DC Converter, battery charger, power supply of printer, copier, HDD, FDD, TV, VCR, personal computer etc.

MAXIMUM RATINGS (T_c = 25°C)

Symbol	Parameter	Conditions	Ratings	Unit
V _{DSS}	Drain-source voltage	V _{GS} = 0V	250	V
V _{GSS}	Gate-source voltage	V _{DS} = 0V	±30	V
I _D	Drain current		16	A
I _{DM}	Drain current (Pulsed)		48	A
P _D	Maximum power dissipation		125	W
T _{ch}	Channel temperature		-55 ~ +150	°C
T _{stg}	Storage temperature		-55 ~ +150	°C
—	Weight	Typical value	1.2	g

FS16VS-5

HIGH-SPEED SWITCHING USE

ELECTRICAL CHARACTERISTICS (T_{ch} = 25°C)

Symbol	Parameter	Test conditions	Limits			Unit
			Min.	Typ.	Max.	
V(BR)DSS	Drain-source breakdown voltage	I _D = 1mA, V _{GS} = 0V	250	—	—	V
V(BR)GSS	Gate-source breakdown voltage	I _G = ±100μA, V _{DS} = 0V	±30	—	—	V
I _{GSS}	Gate-source leakage current	V _{GS} = ±25V, V _{DS} = 0V	—	—	±10	μA
I _{DSS}	Drain-source leakage current	V _{DS} = 250V, V _{GS} = 0V	—	—	1	mA
V _{GS(th)}	Gate-source threshold voltage	I _D = 1mA, V _{DS} = 10V	2	3	4	V
r _{DS(ON)}	Drain-source on-state resistance	I _D = 8A, V _{GS} = 10V	—	0.19	0.25	Ω
V _{DS(ON)}	Drain-source on-state voltage	I _D = 8A, V _{GS} = 10V	—	1.5	2.0	V
y _{fs}	Forward transfer admittance	I _D = 8A, V _{DS} = 10V	6.5	10.0	—	S
C _{iss}	Input capacitance	V _{DS} = 25V, V _{GS} = 0V, f = 1MHz	—	1050	—	pF
C _{oss}	Output capacitance		—	220	—	pF
C _{rss}	Reverse transfer capacitance		—	45	—	pF
t _{d(on)}	Turn-on delay time	V _{DD} = 150V, I _D = 8A, V _{GS} = 10V, R _{GEN} = R _{GS} = 50Ω	—	20	—	ns
t _r	Rise time		—	40	—	ns
t _{d(off)}	Turn-off delay time		—	110	—	ns
t _f	Fall time		—	50	—	ns
V _{SD}	Source-drain voltage		I _S = 8A, V _{GS} = 0V	—	1.5	2.0
R _{th(ch-c)}	Thermal resistance	Channel to case	—	—	1.00	°C/W

PERFORMANCE CURVES

POWER DISSIPATION DERATING CURVE

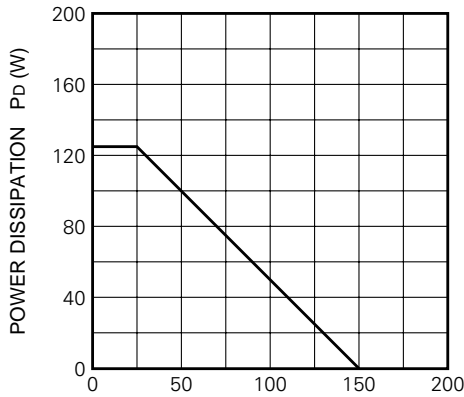

CASE TEMPERATURE T_c (°C)

MAXIMUM SAFE OPERATING AREA

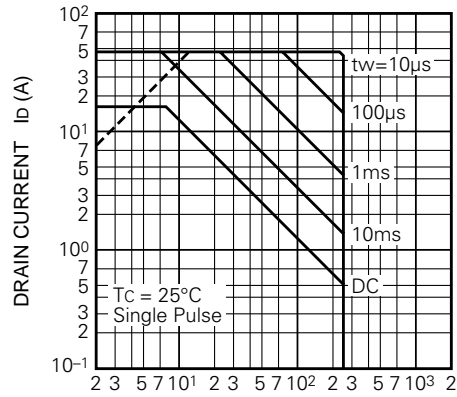

DRAIN-SOURCE VOLTAGE V_{ds} (V)

OUTPUT CHARACTERISTICS (TYPICAL)

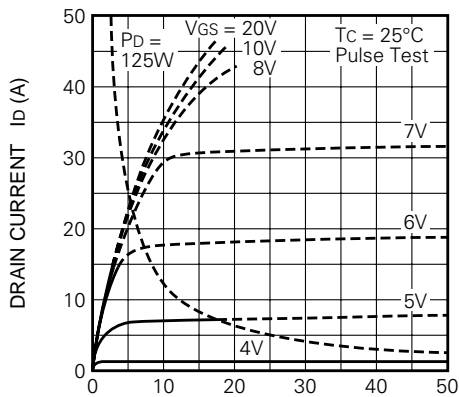

DRAIN-SOURCE VOLTAGE V_{ds} (V)

OUTPUT CHARACTERISTICS (TYPICAL)

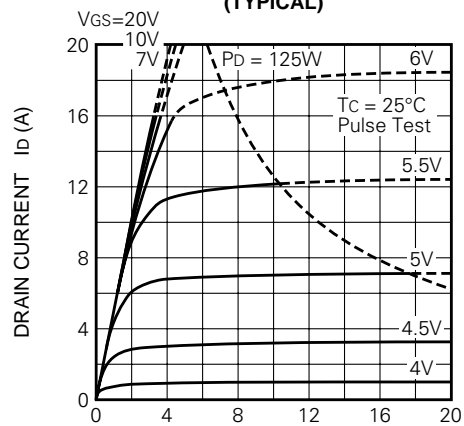

DRAIN-SOURCE VOLTAGE V_{ds} (V)

FS16VS-5

HIGH-SPEED SWITCHING USE

ON-STATE VOLTAGE VS. GATE-SOURCE VOLTAGE (TYPICAL)

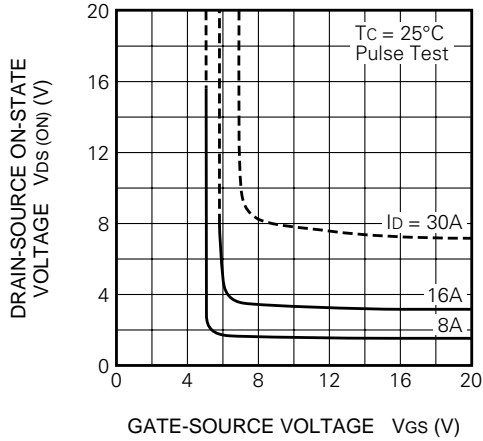

ON-STATE RESISTANCE VS. DRAIN CURRENT (TYPICAL)

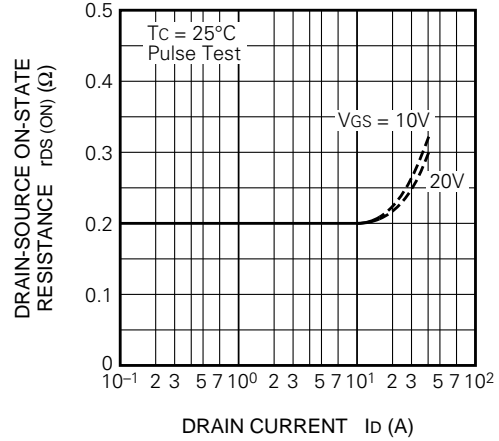

TRANSFER CHARACTERISTICS (TYPICAL)

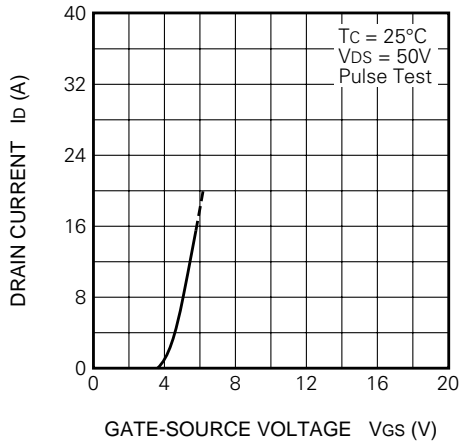

FORWARD TRANSFER ADMITTANCE VS. DRAIN CURRENT (TYPICAL)

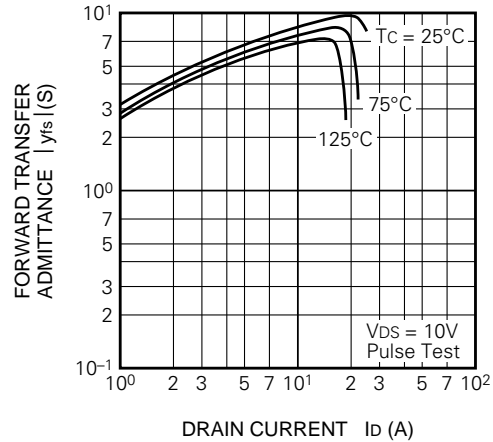

CAPACITANCE VS. DRAIN-SOURCE VOLTAGE (TYPICAL)

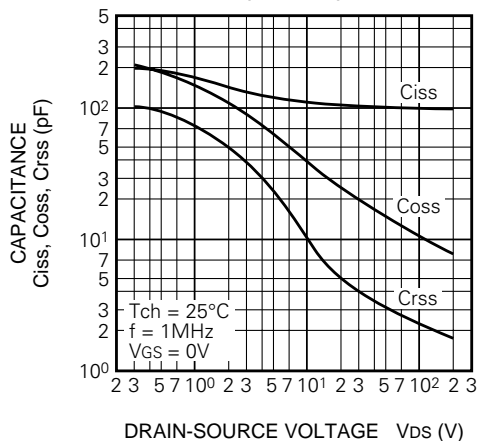

SWITCHING CHARACTERISTICS (TYPICAL)

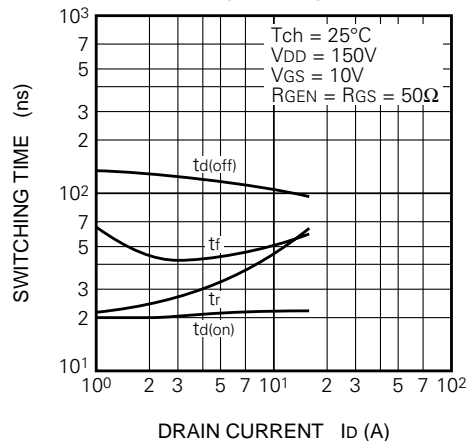

FS16VS-5

HIGH-SPEED SWITCHING USE

GATE-SOURCE VOLTAGE VS. GATE CHARGE (TYPICAL)

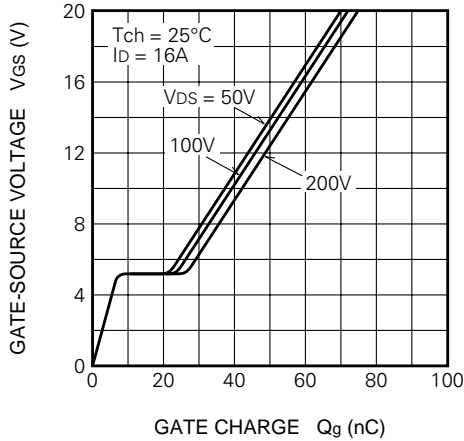

SOURCE-DRAIN DIODE FORWARD CHARACTERISTICS (TYPICAL)

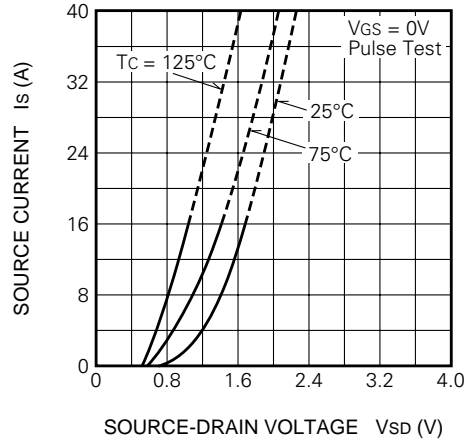

ON-STATE RESISTANCE VS. CHANNEL TEMPERATURE (TYPICAL)

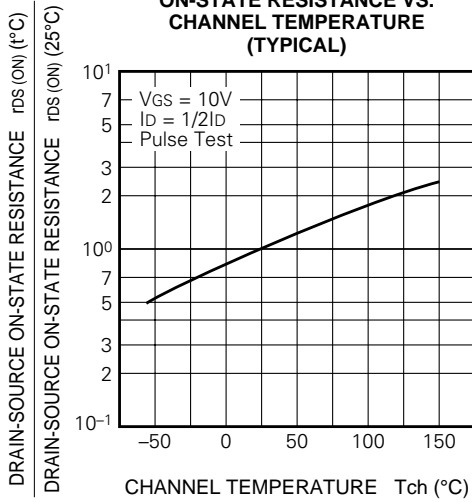

THRESHOLD VOLTAGE VS. CHANNEL TEMPERATURE (TYPICAL)

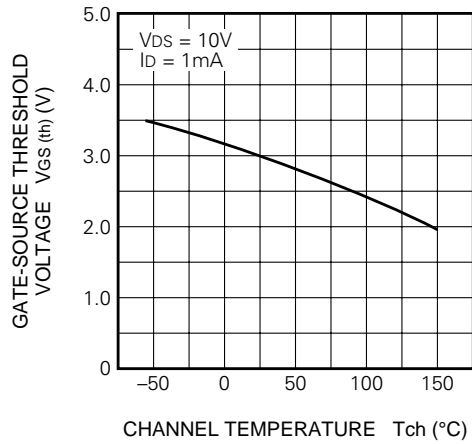

BREAKDOWN VOLTAGE VS. CHANNEL TEMPERATURE (TYPICAL)

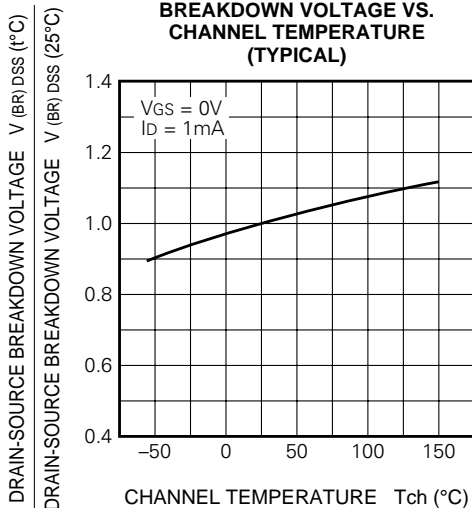

TRANSIENT THERMAL IMPEDANCE CHARACTERISTICS

