

MITSUBISHI Nch POWER MOSFET

# FS18SM-14A

HIGH-SPEED SWITCHING USE

## FS18SM-14A

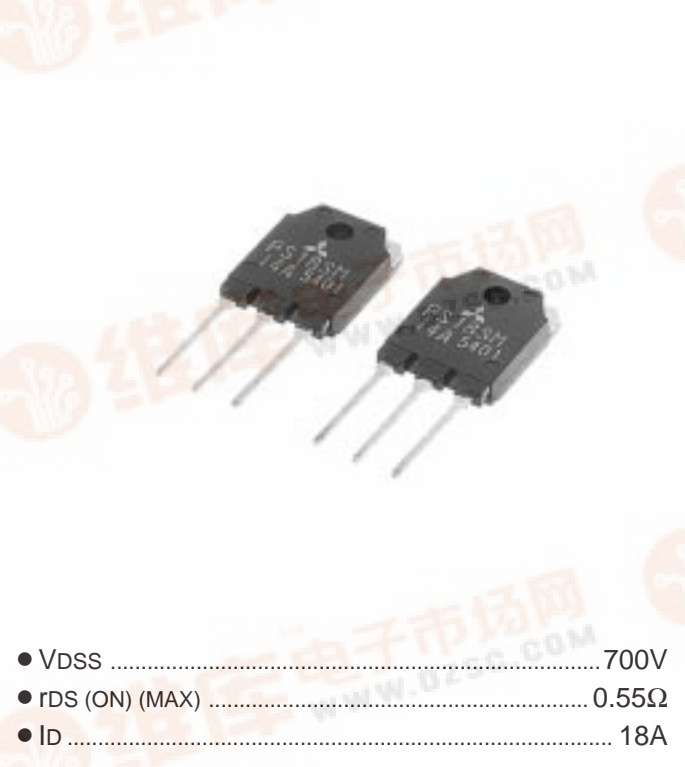

## OUTLINE DRAWING

Dimensions in mm

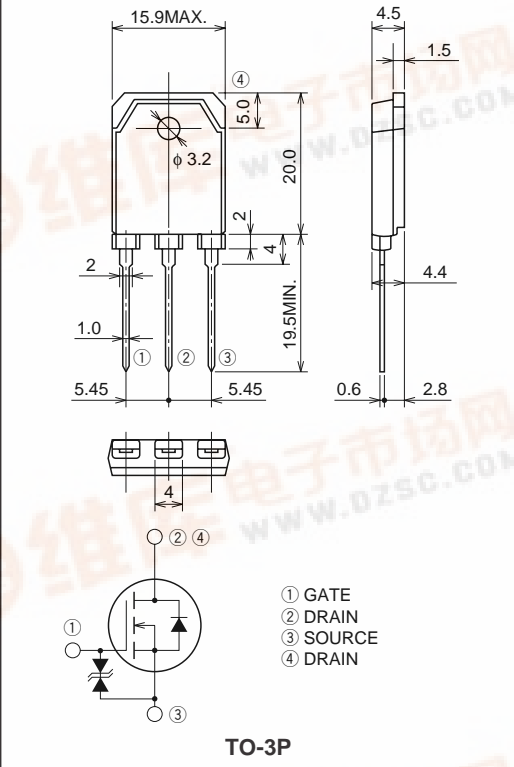

## APPLICATION

SMPS, DC-DC Converter, battery charger, power supply of printer, copier, HDD, FDD, TV, VCR, personal computer etc.

## MAXIMUM RATINGS (Tc = 25°C)

Symbol	Parameter	Conditions	Ratings	Unit
$V_{DS}$	Drain-source voltage	$V_{GS} = 0V$	700	V
$V_{GS}$	Gate-source voltage	$V_{DS} = 0V$	±30	V
$I_D$	Drain current		18	A
$I_{DM}$	Drain current (Pulsed)		54	A
$P_D$	Maximum power dissipation		275	W
$T_{ch}$	Channel temperature		-55 ~ +150	°C
$T_{stg}$	Storage temperature		-55 ~ +150	°C
—	Weight	Typical value	4.8	g

# FS18SM-14A

HIGH-SPEED SWITCHING USE

## ELECTRICAL CHARACTERISTICS (T<sub>ch</sub> = 25°C)

Symbol	Parameter	Test conditions	Limits			Unit
			Min.	Typ.	Max.	
V(BR)DSS	Drain-source breakdown voltage	I <sub>D</sub> = 1mA, V <sub>GS</sub> = 0V	700	—	—	V
V(BR)GSS	Gate-source breakdown voltage	I <sub>GS</sub> = ±100μA, V <sub>DS</sub> = 0V	±30	—	—	V
I <sub>GSS</sub>	Gate-source leakage current	V <sub>GS</sub> = ±25V, V <sub>DS</sub> = 0V	—	—	±10	μA
I <sub>DSS</sub>	Drain-source leakage current	V <sub>DS</sub> = 700V, V <sub>GS</sub> = 0V	—	—	1	mA
V <sub>GS(th)</sub>	Gate-source threshold voltage	I <sub>D</sub> = 1mA, V <sub>DS</sub> = 10V	2	3	4	V
r <sub>DS(ON)</sub>	Drain-source on-state resistance	I <sub>D</sub> = 9A, V <sub>GS</sub> = 10V	—	0.41	0.55	Ω
V <sub>DS(ON)</sub>	Drain-source on-state voltage	I <sub>D</sub> = 9A, V <sub>GS</sub> = 10V	—	3.69	4.95	V
y <sub>fs</sub>	Forward transfer admittance	I <sub>D</sub> = 9A, V <sub>DS</sub> = 10V	10.8	18.0	—	S
C <sub>iss</sub>	Input capacitance	V <sub>DS</sub> = 25V, V <sub>GS</sub> = 0V, f = 1MHz	—	2900	—	pF
C <sub>oss</sub>	Output capacitance		—	340	—	pF
C <sub>rss</sub>	Reverse transfer capacitance		—	60	—	pF
t <sub>d(on)</sub>	Turn-on delay time	V <sub>DD</sub> = 200V, I <sub>D</sub> = 9A, V <sub>GS</sub> = 10V, R <sub>GEN</sub> = R <sub>GS</sub> = 50Ω	—	45	—	ns
t <sub>r</sub>	Rise time		—	75	—	ns
t <sub>d(off)</sub>	Turn-off delay time		—	335	—	ns
t <sub>f</sub>	Fall time		—	110	—	ns
V <sub>SD</sub>	Source-drain voltage		I <sub>S</sub> = 9A, V <sub>GS</sub> = 0V	—	1.0	1.5
R <sub>th(ch-c)</sub>	Thermal resistance	Channel to case	—	—	0.45	°C/W

## PERFORMANCE CURVES

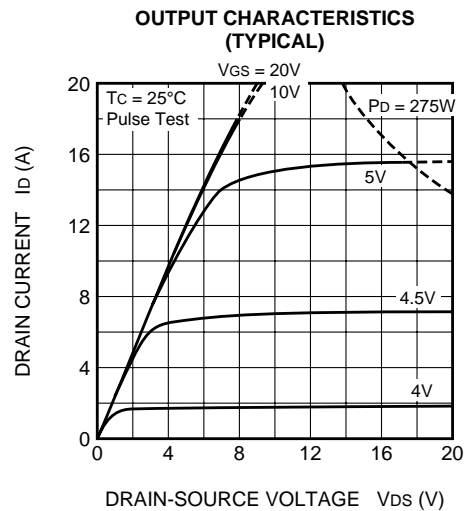
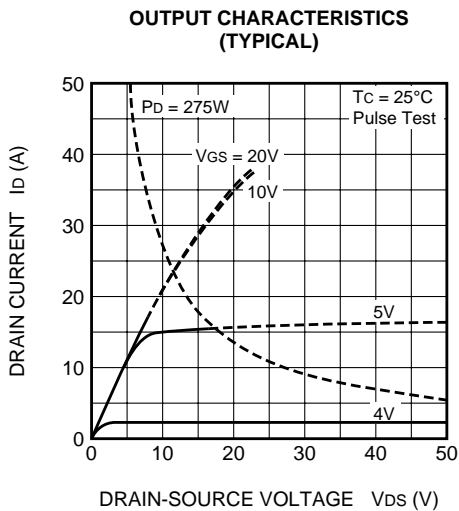
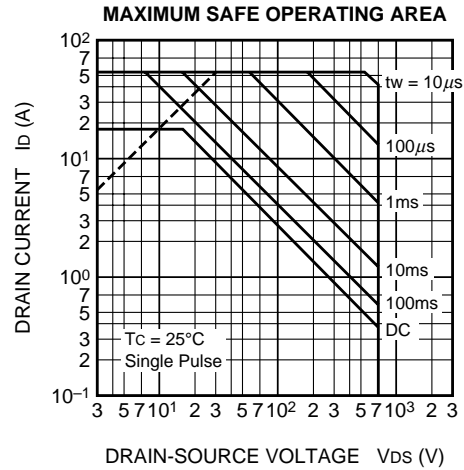
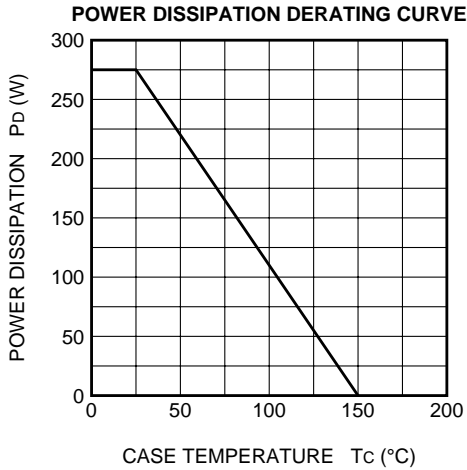

# FS18SM-14A

## HIGH-SPEED SWITCHING USE

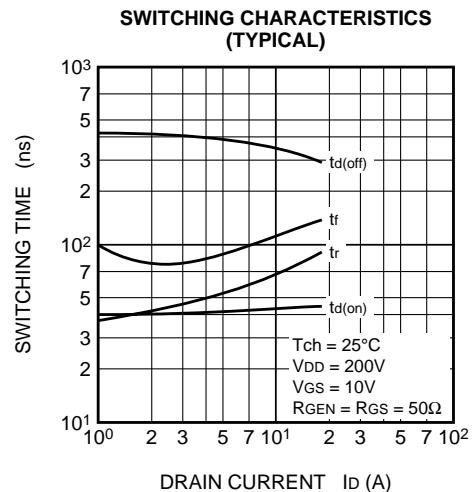
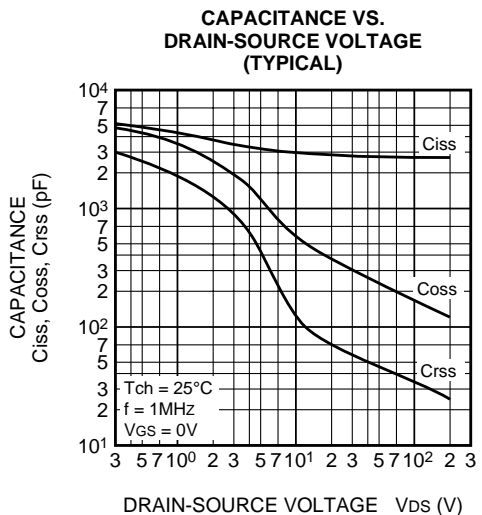
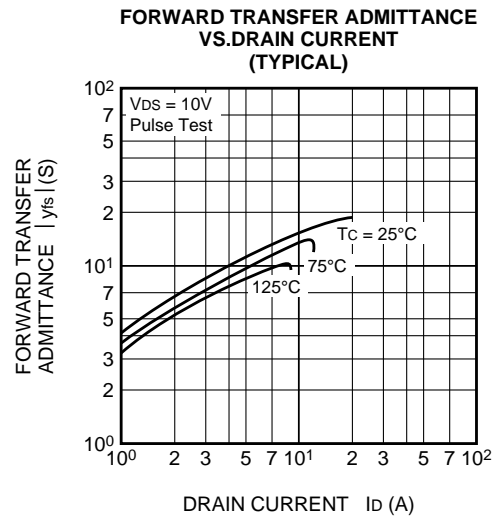
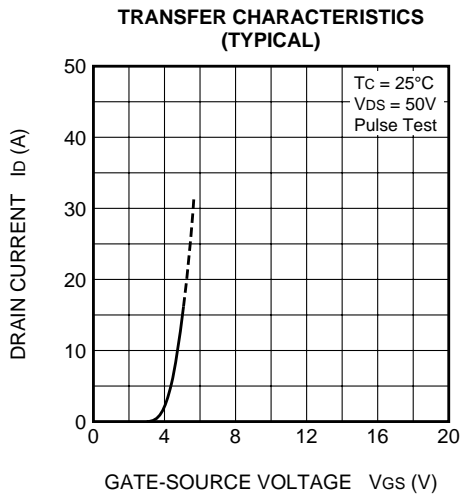
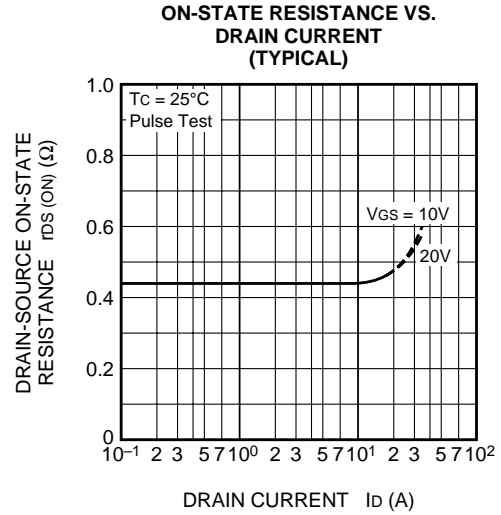
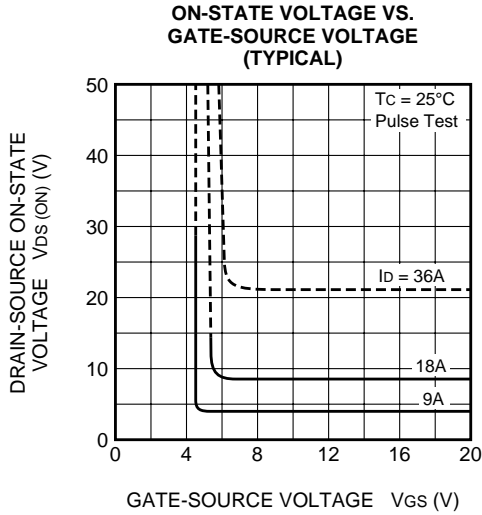

# FS18SM-14A

HIGH-SPEED SWITCHING USE

**GATE-SOURCE VOLTAGE VS. GATE CHARGE (TYPICAL)**

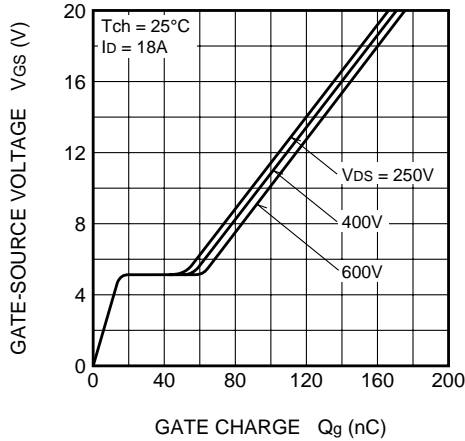

**SOURCE-DRAIN DIODE FORWARD CHARACTERISTICS (TYPICAL)**

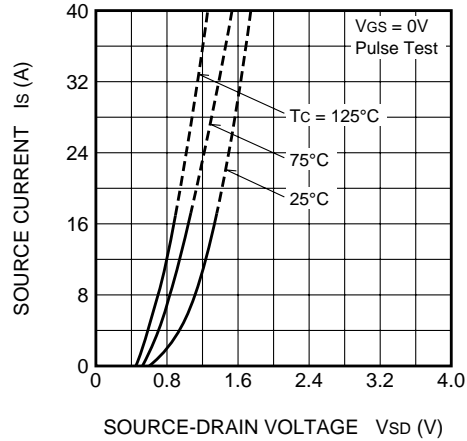

**ON-STATE RESISTANCE VS. CHANNEL TEMPERATURE (TYPICAL)**

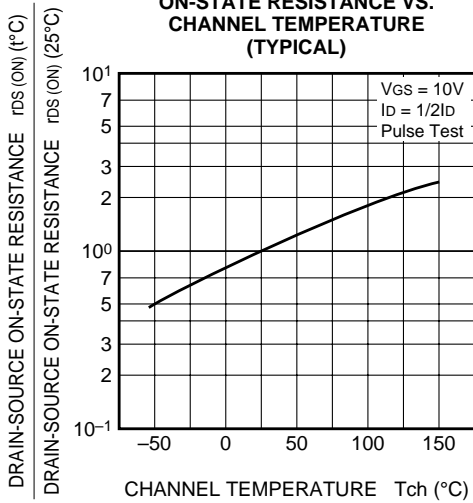

**THRESHOLD VOLTAGE VS. CHANNEL TEMPERATURE (TYPICAL)**

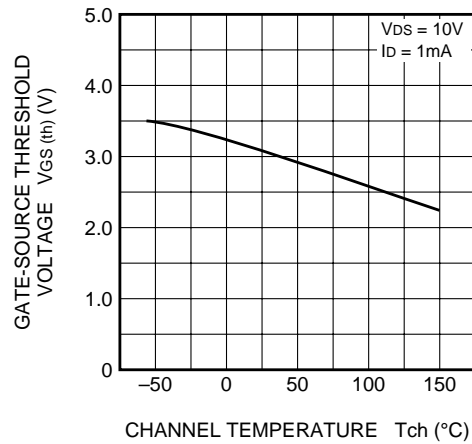

**BREAKDOWN VOLTAGE VS. CHANNEL TEMPERATURE (TYPICAL)**

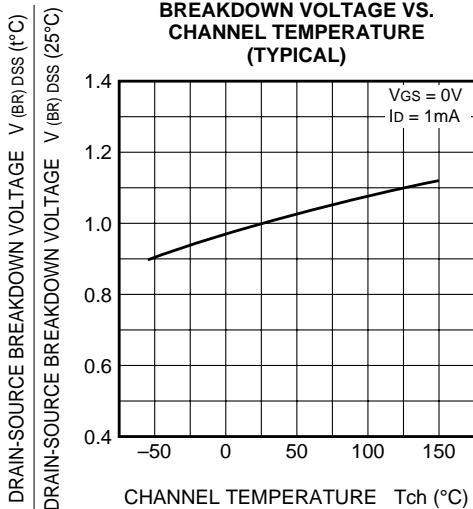

**TRANSIENT THERMAL IMPEDANCE CHARACTERISTICS**

