

MITSUBISHI Nch POWER MOSFET

# FS20VS-6

HIGH-SPEED SWITCHING USE

**FS20VS-6**



- V<sub>DSS</sub> ..... 300V
- r<sub>DS (ON)</sub> (MAX) ..... 0.26Ω
- I<sub>D</sub> ..... 20A

**OUTLINE DRAWING** Dimensions in mm

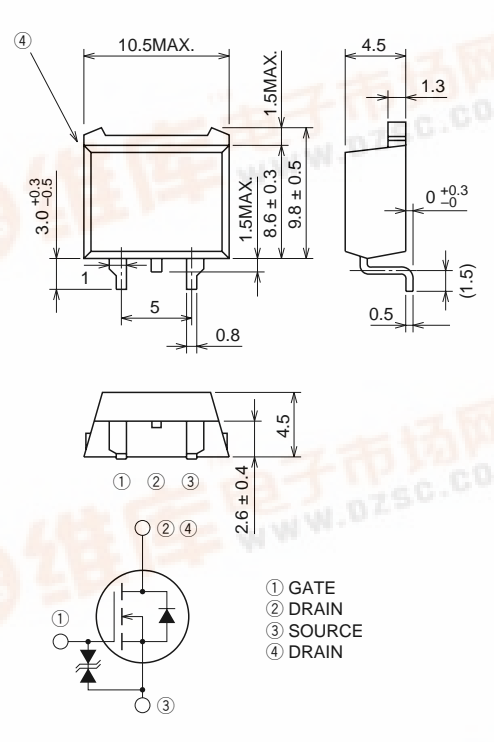

① GATE  
② DRAIN  
③ SOURCE  
④ DRAIN

**TO-220S**

## APPLICATION

SMPS, DC-DC Converter, battery charger, power supply of printer, copier, HDD, FDD, TV, VCR, personal computer etc.

## MAXIMUM RATINGS (T<sub>c</sub> = 25°C)

Symbol	Parameter	Conditions	Ratings	Unit
V <sub>DSS</sub>	Drain-source voltage	V <sub>GS</sub> = 0V	300	V
V <sub>GSS</sub>	Gate-source voltage	V <sub>DS</sub> = 0V	±30	V
I <sub>D</sub>	Drain current		20	A
I <sub>DM</sub>	Drain current (Pulsed)		60	A
P <sub>D</sub>	Maximum power dissipation		150	W
T <sub>ch</sub>	Channel temperature		-55 ~ +150	°C
T <sub>stg</sub>	Storage temperature		-55 ~ +150	°C
—	Weight	Typical value	1.2	g

# FS20VS-6

HIGH-SPEED SWITCHING USE

**ELECTRICAL CHARACTERISTICS** (Tch = 25°C)

Symbol	Parameter	Test conditions	Limits			Unit
			Min.	Typ.	Max.	
V(BR)DSS	Drain-source breakdown voltage	Id = 1mA, Vgs = 0V	300	—	—	V
V(BR)GSS	Gate-source breakdown voltage	Ig = ±100μA, Vds = 0V	±30	—	—	V
Igss	Gate-source leakage current	Vgs = ±25V, Vds = 0V	—	—	±10	μA
Idss	Drain-source leakage current	Vds = 300V, Vgs = 0V	—	—	1	mA
VGS(th)	Gate-source threshold voltage	Id = 1mA, Vds = 10V	2	3	4	V
rDS(ON)	Drain-source on-state resistance	Id = 10A, Vgs = 10V	—	0.20	0.26	Ω
VDS(ON)	Drain-source on-state voltage	Id = 10A, Vgs = 10V	—	2.0	2.6	V
yfs	Forward transfer admittance	Id = 10A, Vds = 10V	8.5	13.0	—	S
Ciss	Input capacitance	Vds = 25V, Vgs = 0V, f = 1MHz	—	1400	—	pF
Coss	Output capacitance		—	280	—	pF
Crss	Reverse transfer capacitance		—	55	—	pF
td(on)	Turn-on delay time	VDD = 150V, Id = 10A, Vgs = 10V, RGEN = RGS = 50Ω	—	25	—	ns
tr	Rise time		—	50	—	ns
td(off)	Turn-off delay time		—	150	—	ns
tf	Fall time		—	65	—	ns
VSD	Source-drain voltage	Is = 10A, Vgs = 0V	—	1.5	2.0	V
Rth(ch-c)	Thermal resistance	Channel to case	—	—	0.83	°C/W

**PERFORMANCE CURVES**

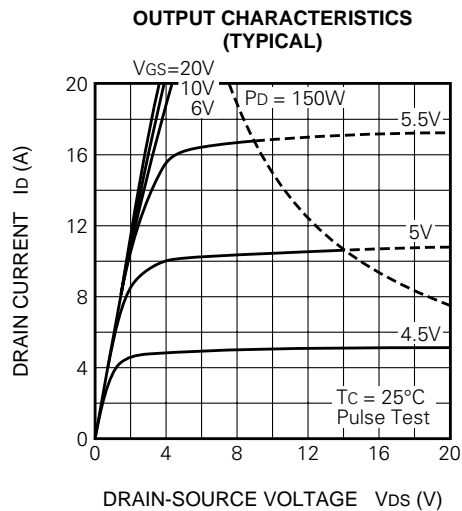
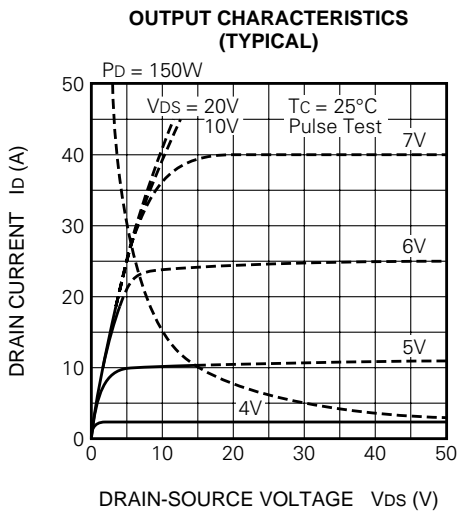
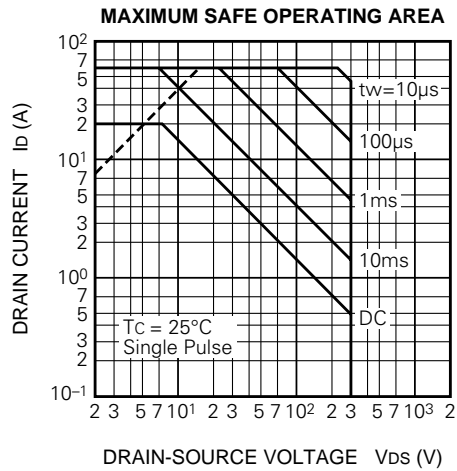
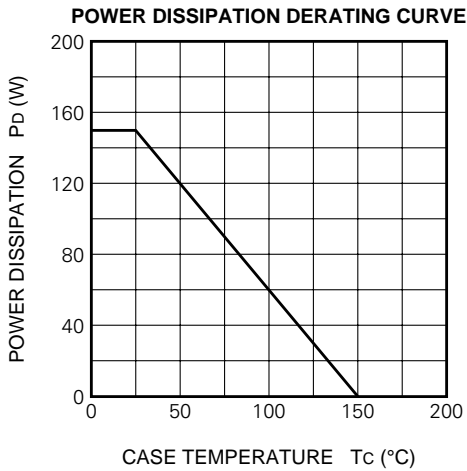

# FS20VS-6

HIGH-SPEED SWITCHING USE

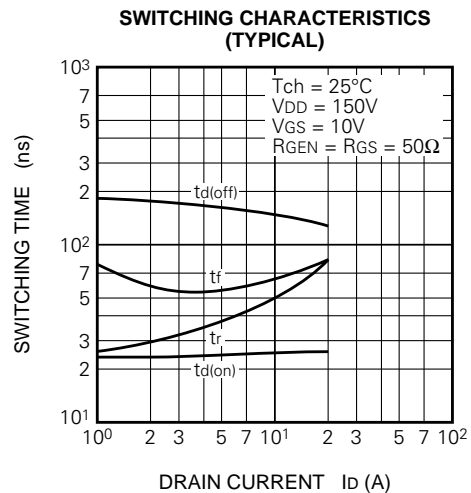
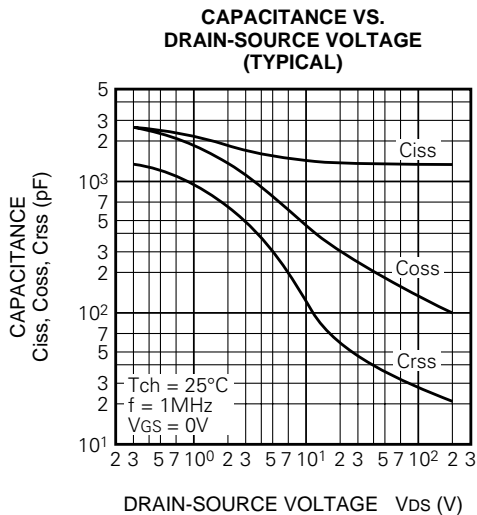
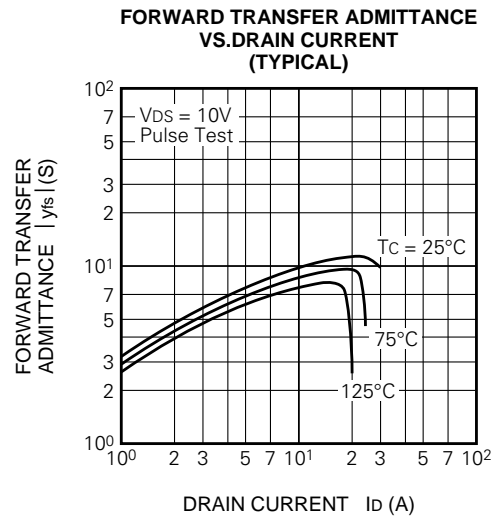
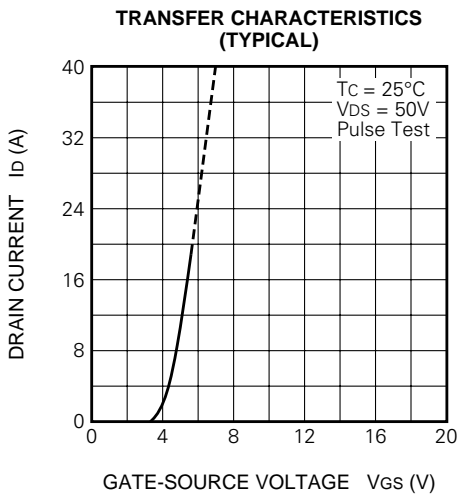
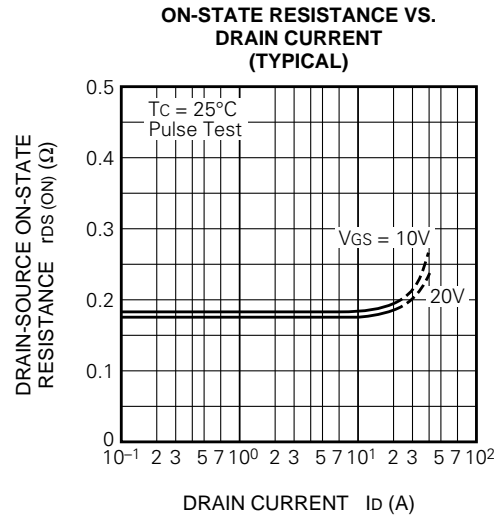
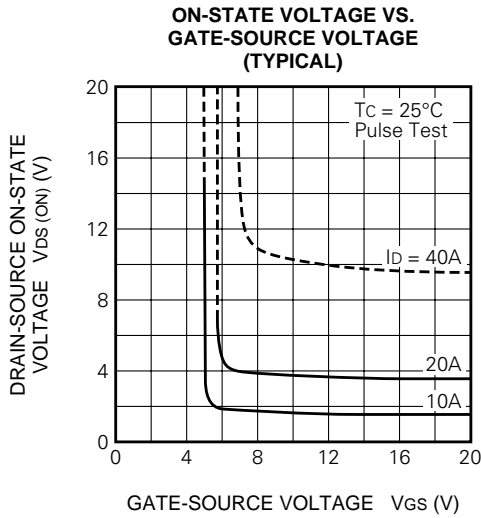

FS20VS-6

HIGH-SPEED SWITCHING USE

