

MITSUBISHI Nch POWER MOSFET

FS30ASJ-06

HIGH-SPEED SWITCHING USE

FS30ASJ-06



- 4V DRIVE
- V_{DSS} 60V
- r_{D(S)} (ON) (MAX) 30mΩ
- I_D 30A
- Integrated Fast Recovery Diode (TYP.) 60ns

OUTLINE DRAWING

Dimensions in mm

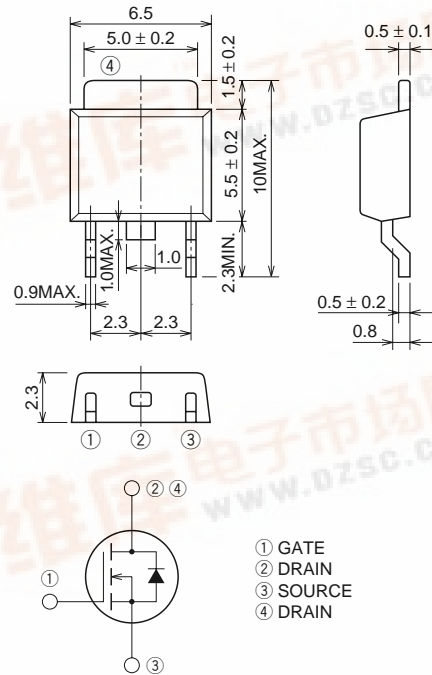

APPLICATION

Motor control, Lamp control, Solenoid control
DC-DC converter, etc.

MAXIMUM RATINGS (T_c = 25°C)

Symbol	Parameter	Conditions	Ratings	Unit
V _{DSS}	Drain-source voltage	V _{GS} = 0V	60	V
V _{GSS}	Gate-source voltage	V _{DS} = 0V	±20	V
I _D	Drain current		30	A
I _{DM}	Drain current (Pulsed)		120	A
I _{DA}	Avalanche drain current (Pulsed)	L = 100μH	30	A
I _S	Source current		30	A
I _{SM}	Source current (Pulsed)		120	A
P _D	Maximum power dissipation		35	W
T _{ch}	Channel temperature		-55 ~ +150	°C
T _{stg}	Storage temperature		-55 ~ +150	°C
—	Weight	Typical value	0.26	g

FS30ASJ-06

HIGH-SPEED SWITCHING USE

ELECTRICAL CHARACTERISTICS (Tch = 25°C)

Symbol	Parameter	Test conditions	Limits			Unit
			Min.	Typ.	Max.	
V(BR)DSS	Drain-source breakdown voltage	Id = 1mA, VGS = 0V	60	—	—	V
IGSS	Gate-source leakage current	VGS = ±20V, VDS = 0V	—	—	±0.1	μA
IDSS	Drain-source leakage current	VDS = 60V, VGS = 0V	—	—	0.1	mA
VGS(th)	Gate-source threshold voltage	Id = 1mA, VDS = 10V	1.0	1.5	2.0	V
rDS(ON)	Drain-source on-state resistance	Id = 15A, VGS = 10V	—	25	30	mΩ
rDS(ON)	Drain-source on-state resistance	Id = 15A, VGS = 4V	—	31	38	mΩ
VDS(ON)	Drain-source on-state voltage	Id = 15A, VGS = 10V	—	0.38	0.45	V
yfs	Forward transfer admittance	Id = 15A, VDS = 10V	—	28	—	S
Ciss	Input capacitance	VDS = 10V, VGS = 0V, f = 1MHz	—	1800	—	pF
Coss	Output capacitance		—	340	—	pF
Crss	Reverse transfer capacitance		—	180	—	pF
td(on)	Turn-on delay time	VDD = 30V, Id = 15A, VGS = 10V, RGEN = RGS = 50Ω	—	17	—	ns
tr	Rise time		—	46	—	ns
td(off)	Turn-off delay time		—	120	—	ns
tf	Fall time		—	95	—	ns
VSD	Source-drain voltage	Is = 15A, VGS = 0V	—	1.0	1.5	V
Rth(ch-c)	Thermal resistance	Channel to case	—	—	3.57	°C/W
trr	Reverse recovery time	Is = 30A, dis/dt = -100A/μs	—	60	—	ns

PERFORMANCE CURVES

POWER DISSIPATION DERATING CURVE

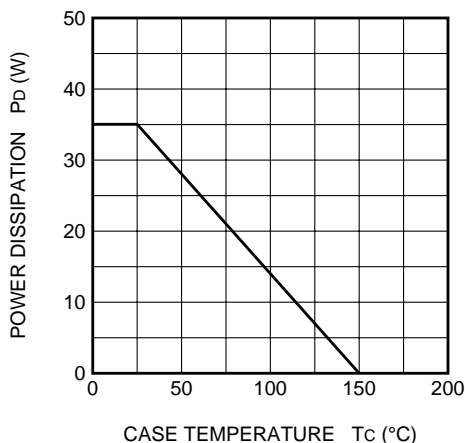

MAXIMUM SAFE OPERATING AREA

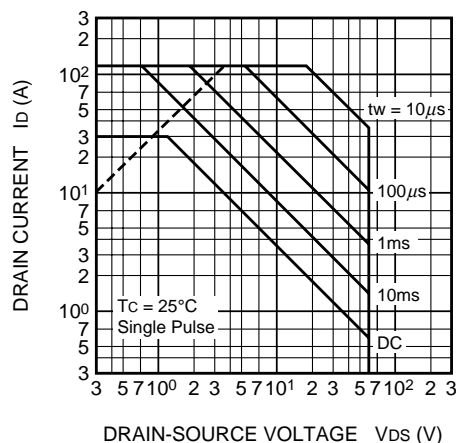

OUTPUT CHARACTERISTICS (TYPICAL)

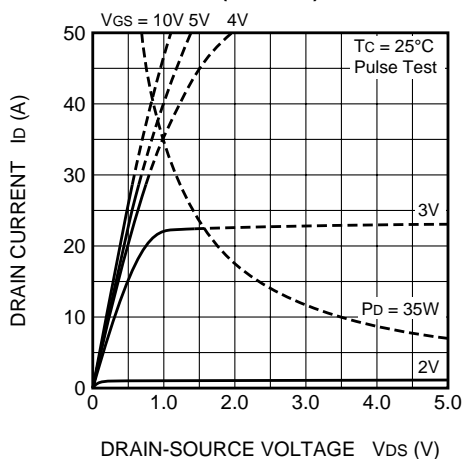

OUTPUT CHARACTERISTICS (TYPICAL)

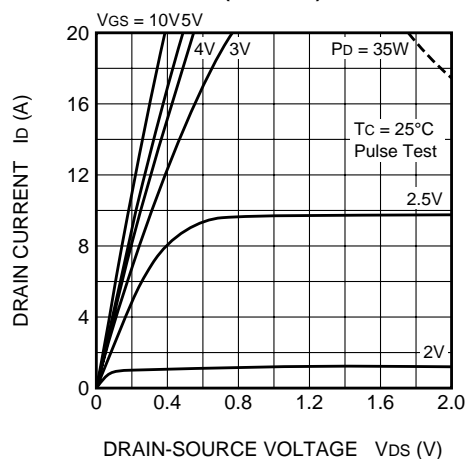

FS30ASJ-06

HIGH-SPEED SWITCHING USE

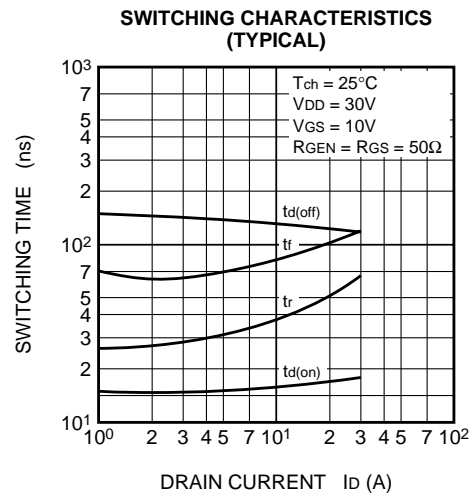
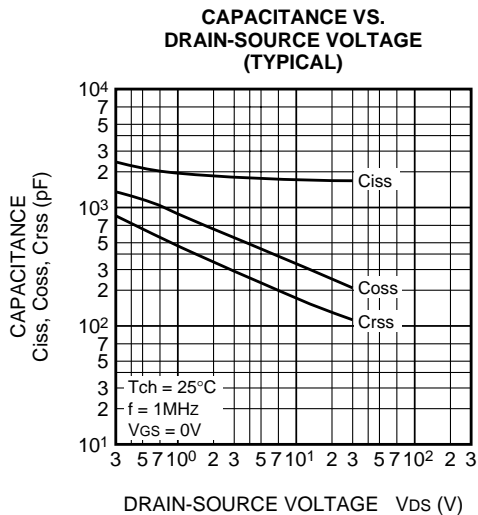
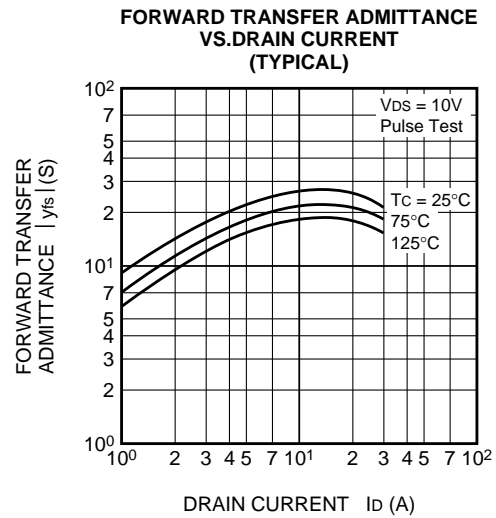
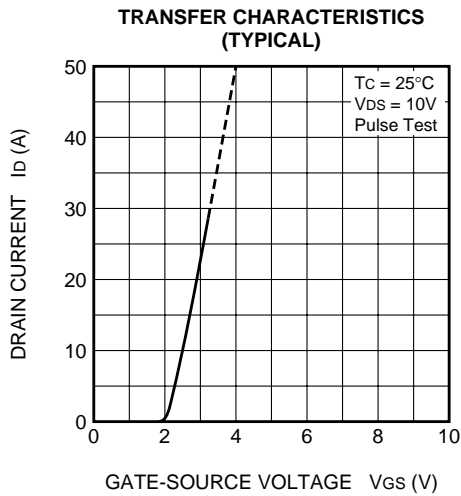
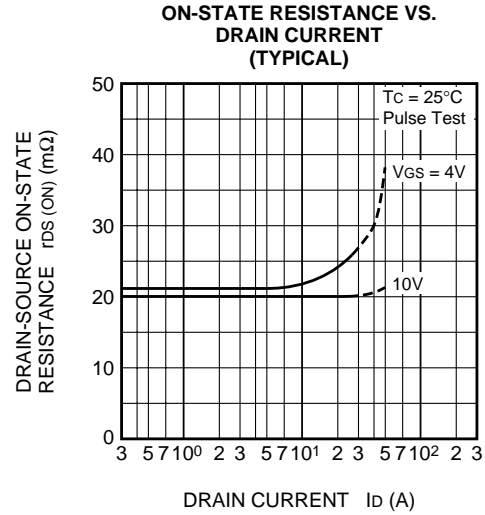
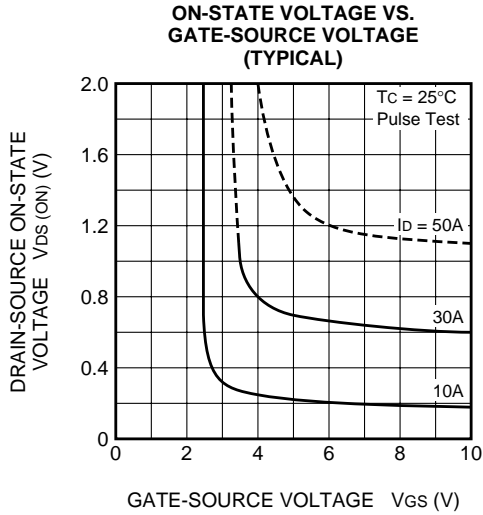

FS30ASJ-06

HIGH-SPEED SWITCHING USE

