

MITSUBISHI Nch POWER MOSFET

FS30KMJ-2

HIGH-SPEED SWITCHING USE

FS30KMJ-2

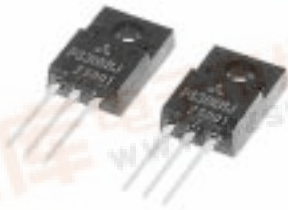

- 4V DRIVE
- V_{DSS} 100V
- r_{DS (ON)} (MAX) 84mΩ
- I_D 30A
- Integrated Fast Recovery Diode (TYP.) 80ns
- V_{iso} 2000V

OUTLINE DRAWING

Dimensions in mm

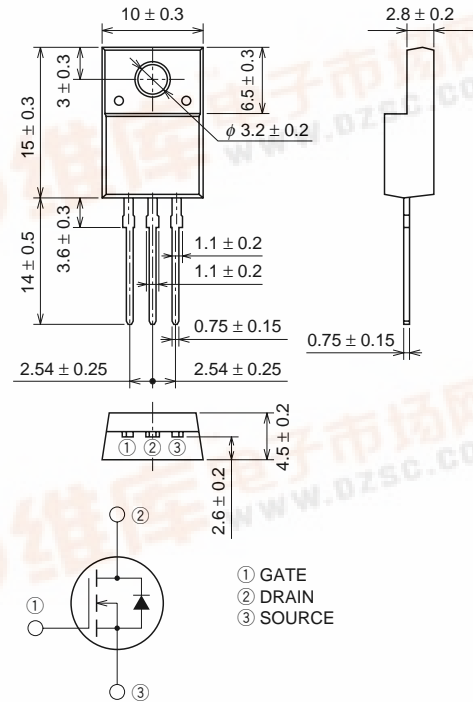

APPLICATION

Motor control, Lamp control, Solenoid control
DC-DC converter, etc.

MAXIMUM RATINGS (T_c = 25°C)

Symbol	Parameter	Conditions	Ratings	Unit
V _{DSS}	Drain-source voltage	V _{GS} = 0V	100	V
V _{GSS}	Gate-source voltage	V _{DS} = 0V	±20	V
I _D	Drain current		30	A
I _{DM}	Drain current (Pulsed)		120	A
I _{DA}	Avalanche drain current (Pulsed)	L = 100μH	30	A
I _S	Source current		30	A
I _{SM}	Source current (Pulsed)		120	A
P _D	Maximum power dissipation		25	W
T _{ch}	Channel temperature		-55 ~ +150	°C
T _{stg}	Storage temperature		-55 ~ +150	°C
V _{iso}	Isolation voltage	AC for 1minute, Terminal to case	2000	V
—	Weight	Typical value	2.0	g

FS30KMJ-2

HIGH-SPEED SWITCHING USE

ELECTRICAL CHARACTERISTICS (T_{ch} = 25°C)

Symbol	Parameter	Test conditions	Limits			Unit
			Min.	Typ.	Max.	
V(BR) _{DSS}	Drain-source breakdown voltage	I _D = 1mA, V _{GS} = 0V	100	—	—	V
I _{GSS}	Gate-source leakage current	V _{GS} = ±20V, V _{DS} = 0V	—	—	±0.1	μA
I _{DSS}	Drain-source leakage current	V _{DS} = 100V, V _{GS} = 0V	—	—	0.1	mA
V _{GS(th)}	Gate-source threshold voltage	I _D = 1mA, V _{DS} = 10V	1.0	1.5	2.0	V
r _{DS(ON)}	Drain-source on-state resistance	I _D = 15A, V _{GS} = 10V	—	65	84	mΩ
r _{DS(ON)}	Drain-source on-state resistance	I _D = 15A, V _{GS} = 4V	—	70	91	mΩ
V _{DS(ON)}	Drain-source on-state voltage	I _D = 15A, V _{GS} = 10V	—	0.98	1.26	V
y _{fs}	Forward transfer admittance	I _D = 15A, V _{DS} = 10V	—	23	—	S
C _{iss}	Input capacitance	V _{DS} = 10V, V _{GS} = 0V, f = 1MHz	—	1800	—	pF
C _{oss}	Output capacitance		—	230	—	pF
C _{rss}	Reverse transfer capacitance		—	120	—	pF
t _{d(on)}	Turn-on delay time	V _{DD} = 50V, I _D = 15A, V _{GS} = 10V, R _{GEN} = R _{GS} = 50Ω	—	17	—	ns
t _r	Rise time		—	46	—	ns
t _{d(off)}	Turn-off delay time		—	135	—	ns
t _f	Fall time		—	95	—	ns
V _{SD}	Source-drain voltage	I _S = 15A, V _{GS} = 0V	—	1.0	1.5	V
R _{th(ch-c)}	Thermal resistance	Channel to case	—	—	5.00	°C/W
t _{rr}	Reverse recovery time	I _S = 30A, di/dt = -100A/μs	—	80	—	ns

PERFORMANCE CURVES

POWER DISSIPATION DERATING CURVE

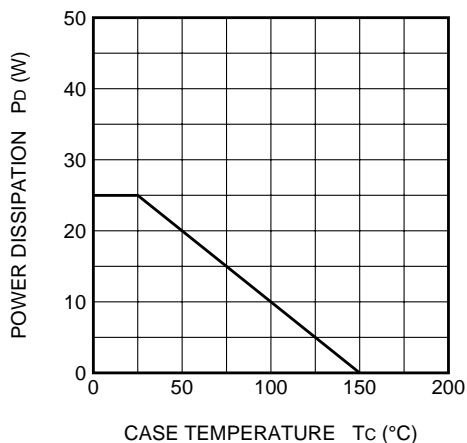

MAXIMUM SAFE OPERATING AREA

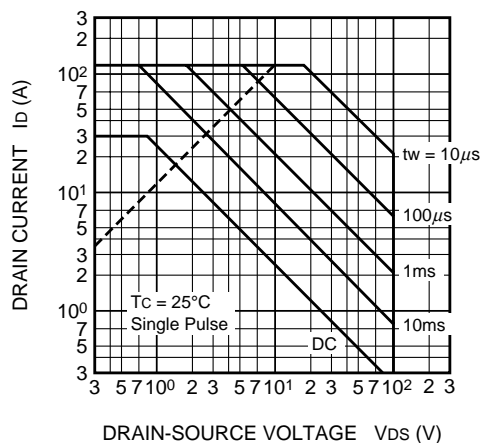

OUTPUT CHARACTERISTICS (TYPICAL)

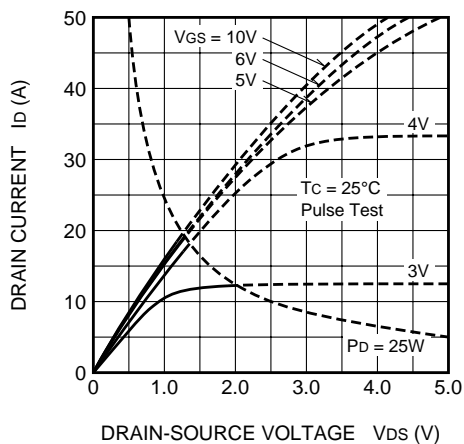

OUTPUT CHARACTERISTICS (TYPICAL)

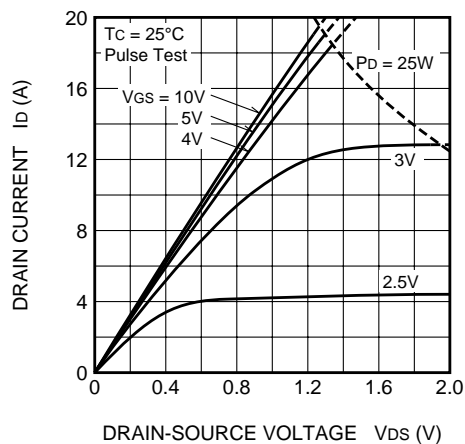

FS30KMJ-2

HIGH-SPEED SWITCHING USE

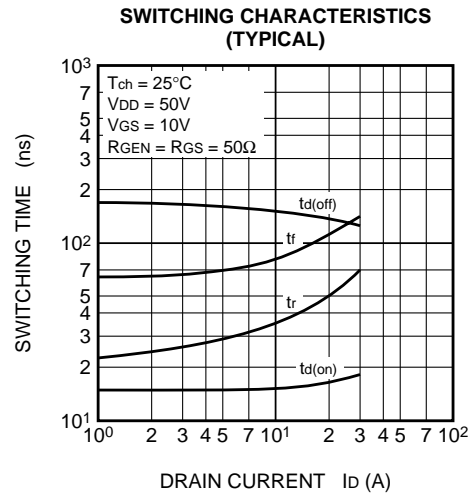
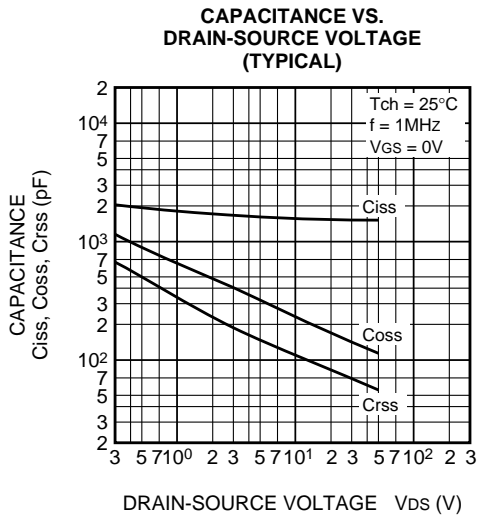
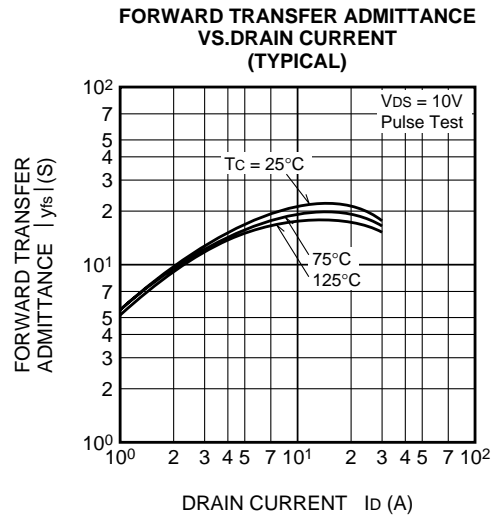
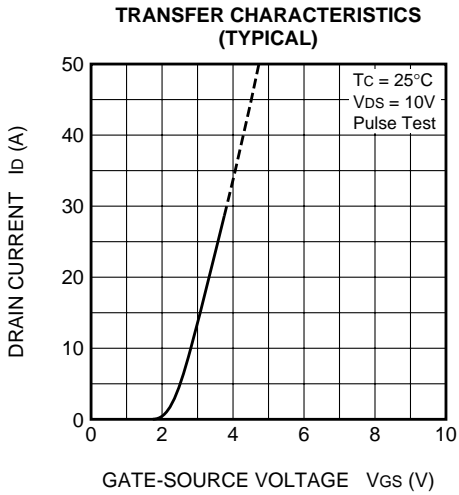
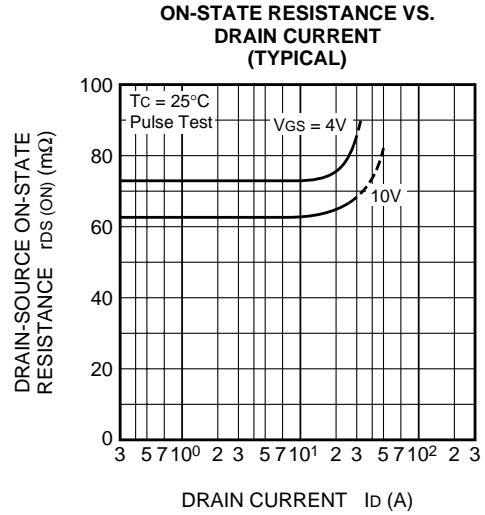
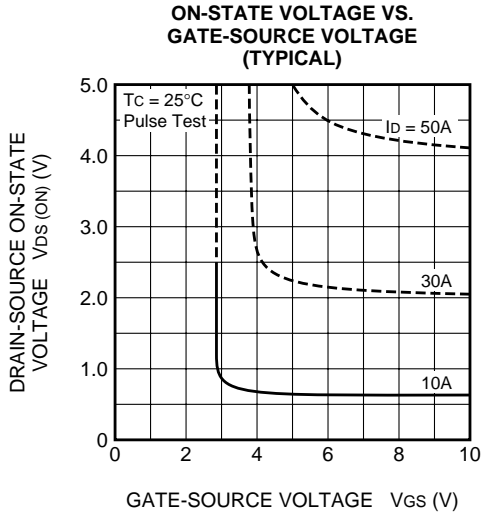

FS30KMJ-2

HIGH-SPEED SWITCHING USE

