

MITSUBISHI Nch POWER MOSFET

FS50SM-06

HIGH-SPEED SWITCHING USE

FS50SM-06

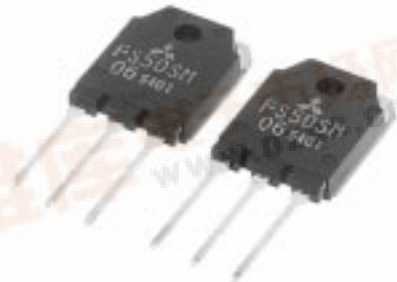

- 10V DRIVE
- V_{DSS} 60V
- r_{DS} (ON) (MAX) 22mΩ
- I_D 50A
- Integrated Fast Recovery Diode (TYP.) 65ns

OUTLINE DRAWING

Dimensions in mm

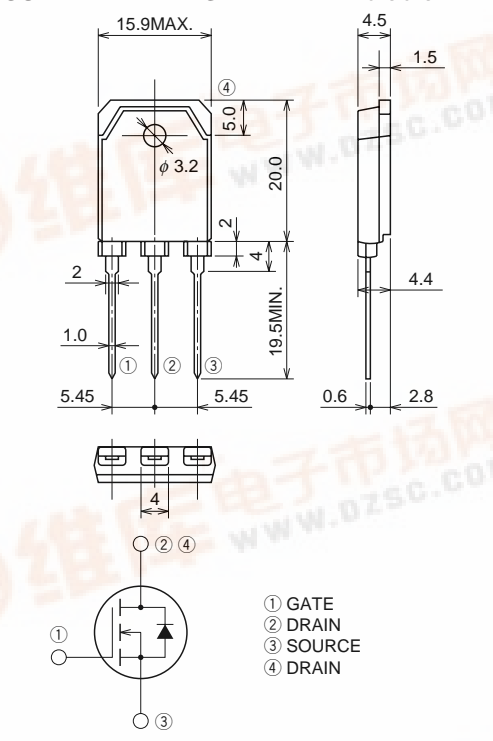

① GATE
② DRAIN
③ SOURCE
④ DRAIN

TO-3P

APPLICATION

Motor control, Lamp control, Solenoid control
DC-DC converter, etc.

MAXIMUM RATINGS (T_c = 25°C)

Symbol	Parameter	Conditions	Ratings	Unit
V _{DSS}	Drain-source voltage	V _{GS} = 0V	60	V
V _{GSS}	Gate-source voltage	V _{DS} = 0V	±20	V
I _D	Drain current		50	A
I _{DM}	Drain current (Pulsed)		200	A
I _{DA}	Avalanche drain current (Pulsed)	L = 100μH	50	A
I _S	Source current		50	A
I _{SM}	Source current (Pulsed)		200	A
P _D	Maximum power dissipation		70	W
T _{ch}	Channel temperature		-55 ~ +150	°C
T _{stg}	Storage temperature		-55 ~ +150	°C
—	Weight	Typical value	4.8	g



FS50SM-06

HIGH-SPEED SWITCHING USE

ELECTRICAL CHARACTERISTICS (T_{ch} = 25°C)

Symbol	Parameter	Test conditions	Limits			Unit
			Min.	Typ.	Max.	
V(BR) _{DSS}	Drain-source breakdown voltage	I _D = 1mA, V _{GS} = 0V	60	—	—	V
I _{GSS}	Gate-source leakage current	V _{GS} = ±20V, V _{DS} = 0V	—	—	±0.1	μA
I _{DSS}	Drain-source leakage current	V _{DS} = 60V, V _{GS} = 0V	—	—	0.1	mA
V _{GS(th)}	Gate-source threshold voltage	I _D = 1mA, V _{DS} = 10V	2.0	3.0	4.0	V
r _{DS(on)}	Drain-source on-state resistance	I _D = 25A, V _{GS} = 10V	—	17	22	mΩ
V _{DS(on)}	Drain-source on-state voltage	I _D = 25A, V _{GS} = 10V	—	0.43	0.55	V
y _{fs}	Forward transfer admittance	I _D = 25A, V _{DS} = 10V	—	32	—	S
C _{iss}	Input capacitance	V _{DS} = 10V, V _{GS} = 0V, f = 1MHz	—	2300	—	pF
C _{oss}	Output capacitance		—	570	—	pF
C _{rss}	Reverse transfer capacitance		—	280	—	pF
t _{d(on)}	Turn-on delay time	V _{DD} = 30V, I _D = 25A, V _{GS} = 10V, R _{GEN} = R _{GS} = 50Ω	—	35	—	ns
t _r	Rise time		—	95	—	ns
t _{d(off)}	Turn-off delay time		—	95	—	ns
t _f	Fall time		—	80	—	ns
V _{SD}	Source-drain voltage	I _S = 25A, V _{GS} = 0V	—	1.0	1.5	V
R _{th(ch-c)}	Thermal resistance	Channel to case	—	—	1.78	°C/W
t _{rr}	Reverse recovery time	I _S = 50A, dis/dt = -100A/μs	—	65	—	ns

PERFORMANCE CURVES

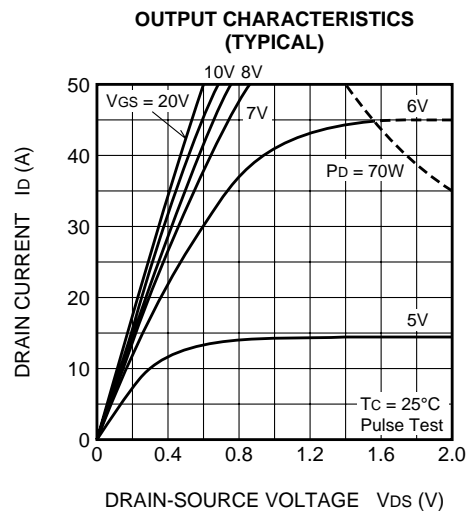
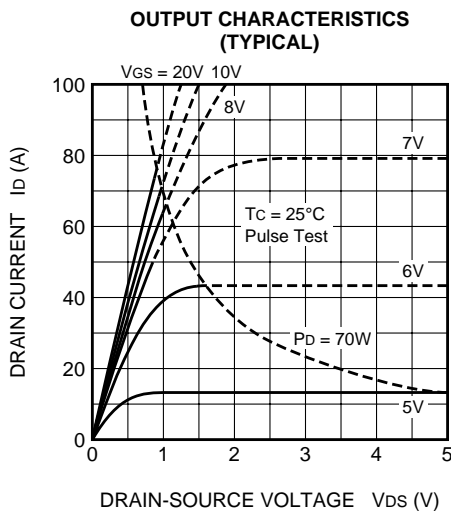
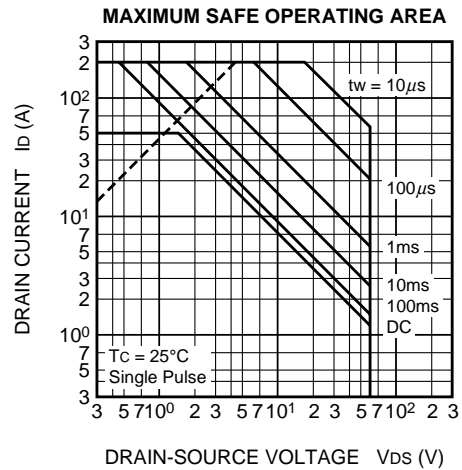
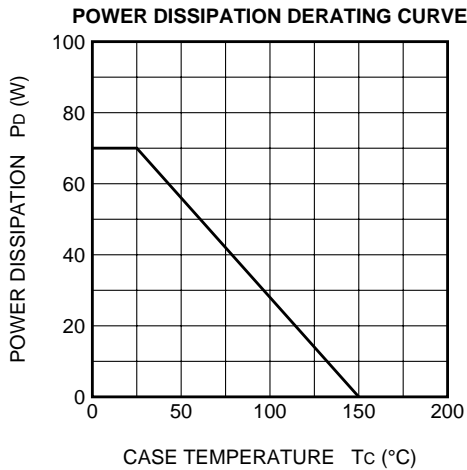

FS50SM-06

HIGH-SPEED SWITCHING USE

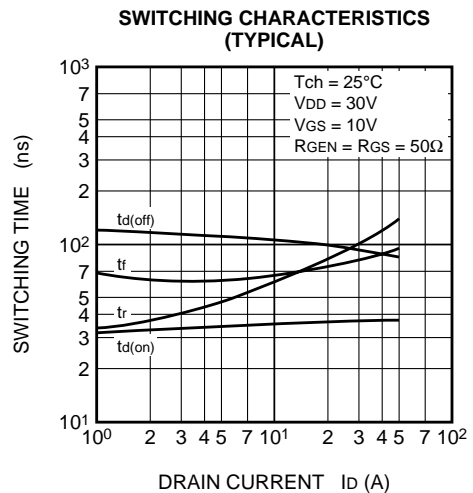
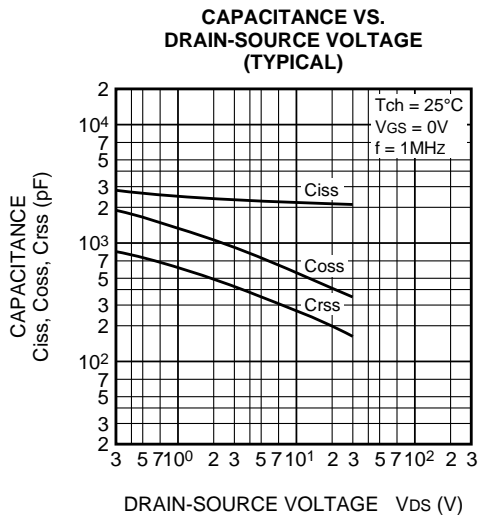
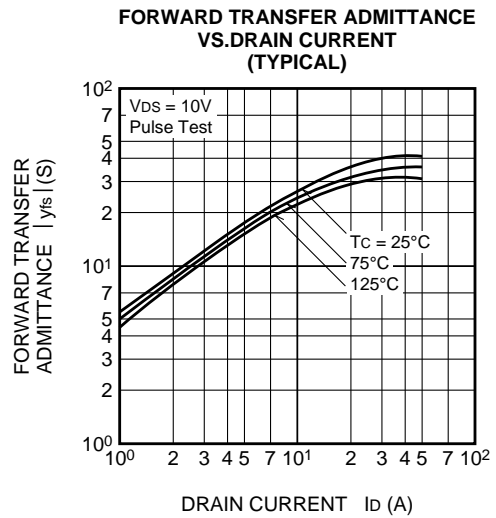
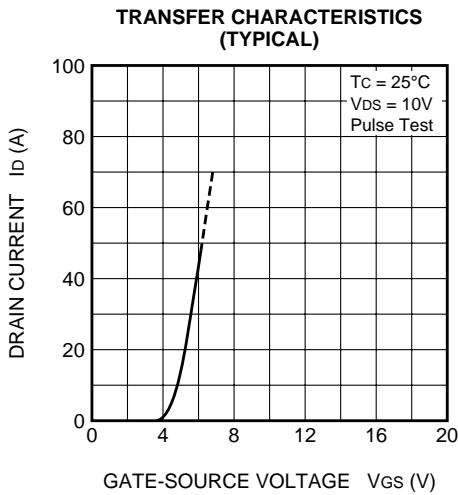
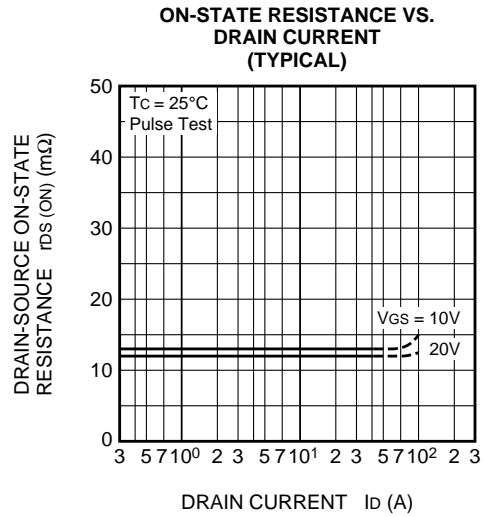
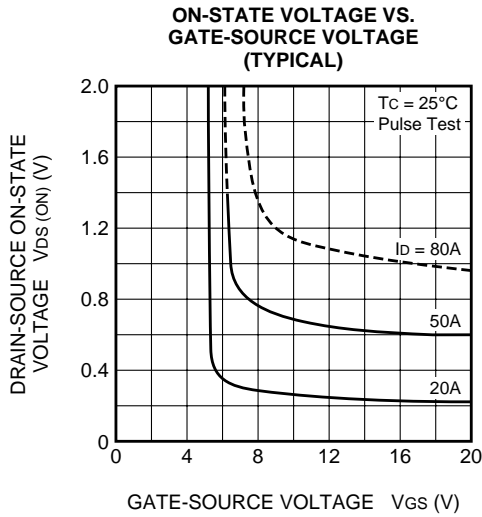

FS50SM-06

HIGH-SPEED SWITCHING USE

GATE-SOURCE VOLTAGE VS. GATE CHARGE (TYPICAL)

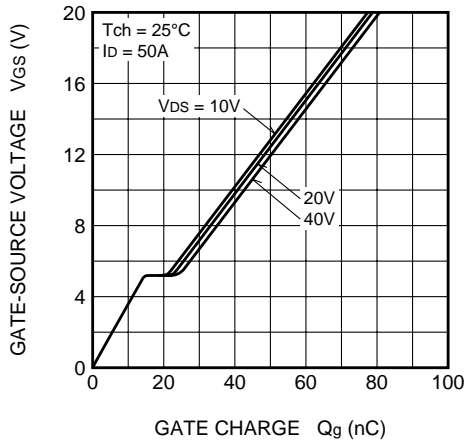

SOURCE-DRAIN DIODE FORWARD CHARACTERISTICS (TYPICAL)

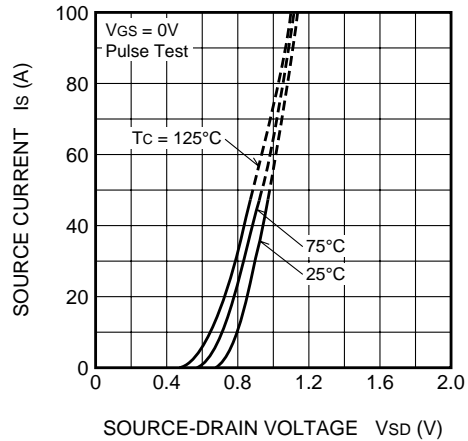

ON-STATE RESISTANCE VS. CHANNEL TEMPERATURE (TYPICAL)

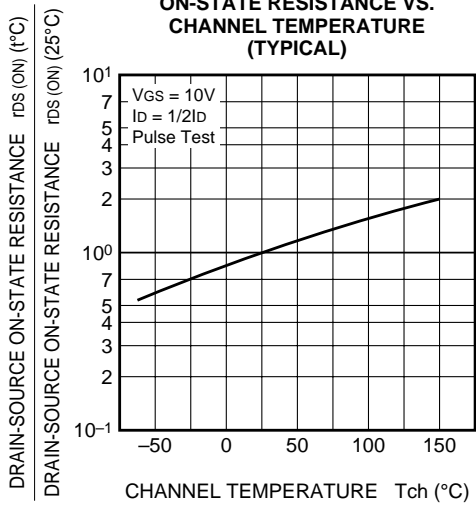

THRESHOLD VOLTAGE VS. CHANNEL TEMPERATURE (TYPICAL)

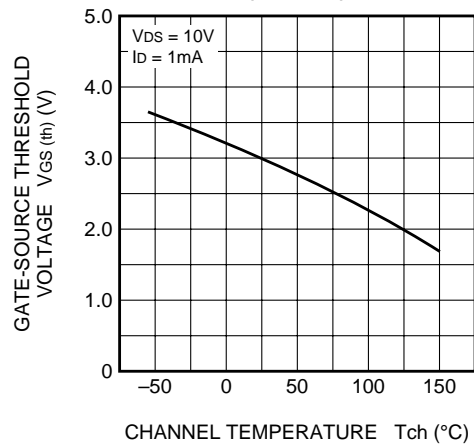

BREAKDOWN VOLTAGE VS. CHANNEL TEMPERATURE (TYPICAL)

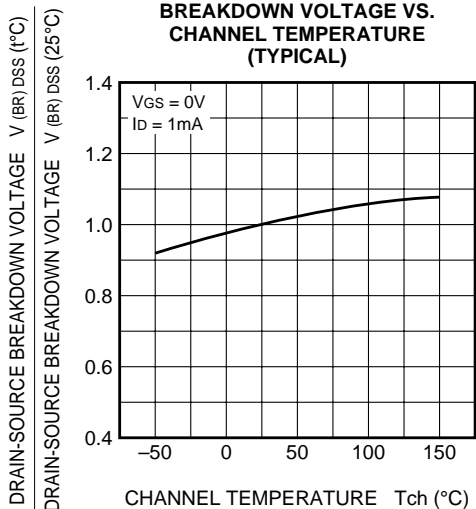

TRANSIENT THERMAL IMPEDANCE CHARACTERISTICS

