

MITSUBISHI Nch POWER MOSFET

# FS5VS-18A

HIGH-SPEED SWITCHING USE

## FS5VS-18A



- V<sub>DSS</sub> ..... 900V
- r<sub>DS (ON)</sub> (MAX) ..... 2.8Ω
- I<sub>D</sub> ..... 5A

## OUTLINE DRAWING

Dimensions in mm

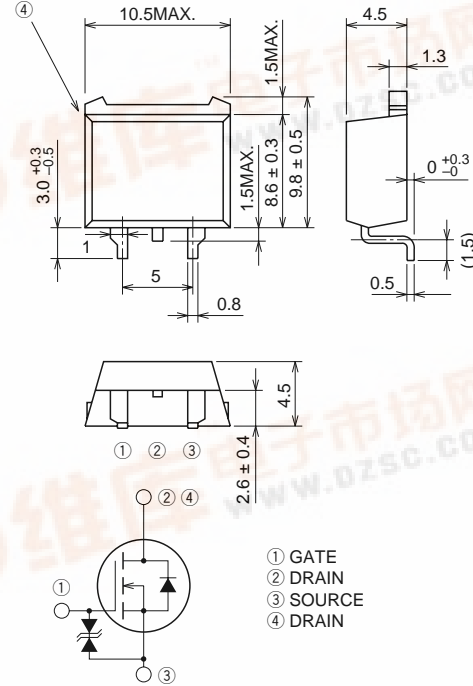

TO-220S

## APPLICATION

SMPS, DC-DC Converter, battery charger, power supply of printer, copier, HDD, FDD, TV, VCR, personal computer etc.

## MAXIMUM RATINGS (T<sub>c</sub> = 25°C)

| Symbol           | Parameter                 | Conditions           | Ratings    | Unit |
|------------------|---------------------------|----------------------|------------|------|
| V <sub>DSS</sub> | Drain-source voltage      | V <sub>GS</sub> = 0V | 900        | V    |
| V <sub>GSS</sub> | Gate-source voltage       | V <sub>DS</sub> = 0V | ±30        | V    |
| I <sub>D</sub>   | Drain current             |                      | 5          | A    |
| I <sub>DM</sub>  | Drain current (Pulsed)    |                      | 15         | A    |
| P <sub>D</sub>   | Maximum power dissipation |                      | 125        | W    |
| T <sub>ch</sub>  | Channel temperature       |                      | -55 ~ +150 | °C   |
| T <sub>stg</sub> | Storage temperature       |                      | -55 ~ +150 | °C   |
| —                | Weight                    | Typical value        | 1.2        | g    |



# FS5VS-18A

HIGH-SPEED SWITCHING USE

## ELECTRICAL CHARACTERISTICS (T<sub>ch</sub> = 25°C)

| Symbol                | Parameter                        | Test conditions   | Limits                                    |      |      | Unit |
|-----------------------|----------------------------------|---|---|------|------|------|
|                       |                                  |   | Min.                                      | Typ. | Max. |      |
| V(BR)DSS              | Drain-source breakdown voltage   | I <sub>D</sub> = 1mA, V <sub>GS</sub> = 0V  | 900                                       | —    | —    | V    |
| V(BR)GSS              | Gate-source breakdown voltage    | I <sub>GS</sub> = ±100μA, V <sub>DS</sub> = 0V  | ±30                                       | —    | —    | V    |
| I <sub>GSS</sub>      | Gate-source leakage current      | V <sub>GS</sub> = ±25V, V <sub>DS</sub> = 0V  | —   | —    | ±10  | μA   |
| I <sub>DSS</sub>      | Drain-source leakage current     | V <sub>DS</sub> = 900V, V <sub>GS</sub> = 0V  | —   | —    | 1    | mA   |
| V <sub>GS(th)</sub>   | Gate-source threshold voltage    | I <sub>D</sub> = 1mA, V <sub>DS</sub> = 10V   | 2   | 3    | 4    | V    |
| r <sub>DS(ON)</sub>   | Drain-source on-state resistance | I <sub>D</sub> = 2A, V <sub>GS</sub> = 10V  | —   | 2.15 | 2.80 | Ω    |
| V <sub>DS(ON)</sub>   | Drain-source on-state voltage    | I <sub>D</sub> = 2A, V <sub>GS</sub> = 10V  | —   | 4.30 | 5.60 | V    |
| y <sub>fs</sub>       | Forward transfer admittance      | I <sub>D</sub> = 2A, V <sub>DS</sub> = 10V  | 3.0                                       | 5.0  | —    | S    |
| C <sub>iss</sub>      | Input capacitance                | V <sub>DS</sub> = 25V, V <sub>GS</sub> = 0V, f = 1MHz   | —   | 1050 | —    | pF   |
| C <sub>oss</sub>      | Output capacitance               |   | —   | 100  | —    | pF   |
| C <sub>rss</sub>      | Reverse transfer capacitance     |   | —   | 20   | —    | pF   |
| t <sub>d(on)</sub>    | Turn-on delay time               | V <sub>DD</sub> = 200V, I <sub>D</sub> = 2A, V <sub>GS</sub> = 10V,<br>R <sub>GEN</sub> = R <sub>GS</sub> = 50Ω | —   | 20   | —    | ns   |
| t <sub>r</sub>        | Rise time                        |   | —   | 18   | —    | ns   |
| t <sub>d(off)</sub>   | Turn-off delay time              |   | —   | 110  | —    | ns   |
| t <sub>f</sub>        | Fall time                        |   | —   | 35   | —    | ns   |
| V <sub>SD</sub>       | Source-drain voltage             |   | I <sub>S</sub> = 2A, V <sub>GS</sub> = 0V | —    | 1.0  | 1.5  |
| R <sub>th(ch-c)</sub> | Thermal resistance               | Channel to case   | —   | —    | 1.0  | °C/W |

## PERFORMANCE CURVES

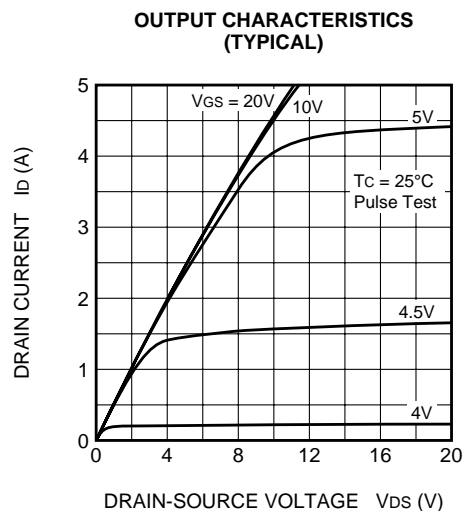
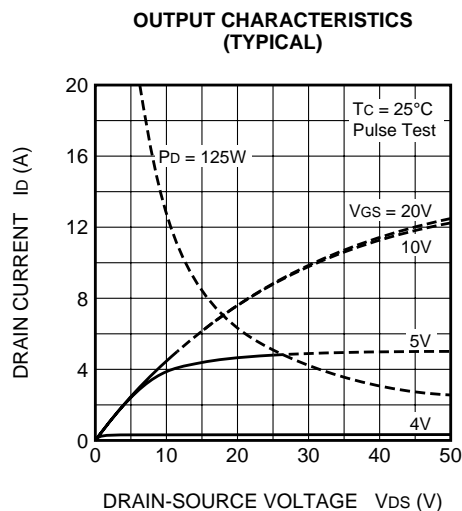
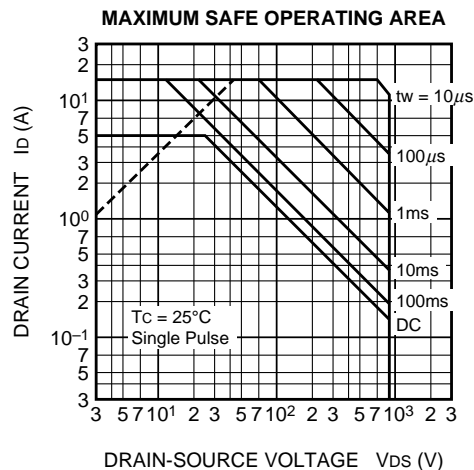
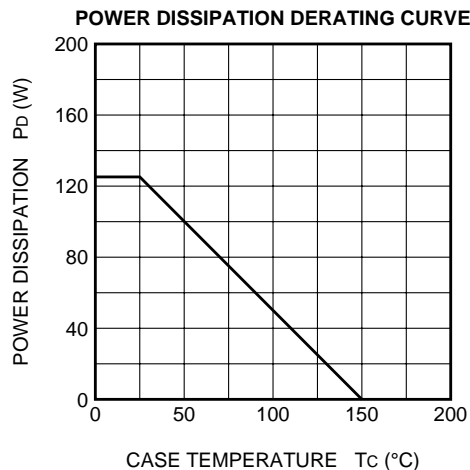

# FS5VS-18A

HIGH-SPEED SWITCHING USE

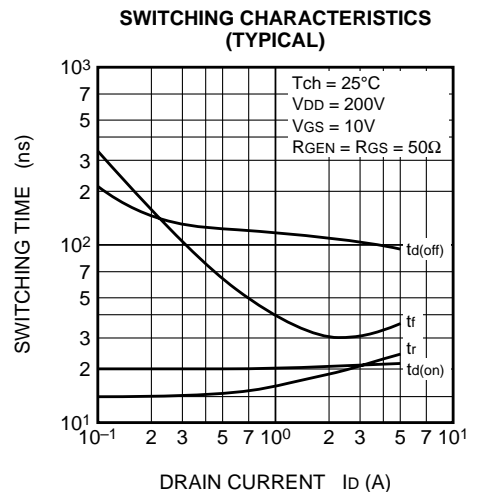
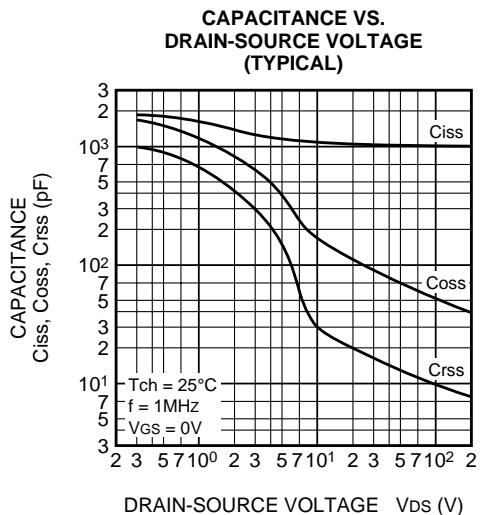
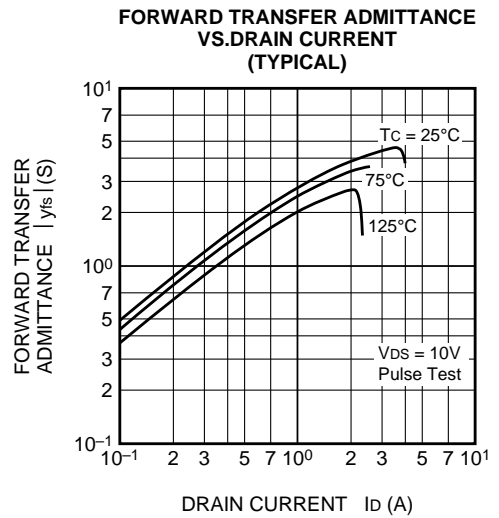
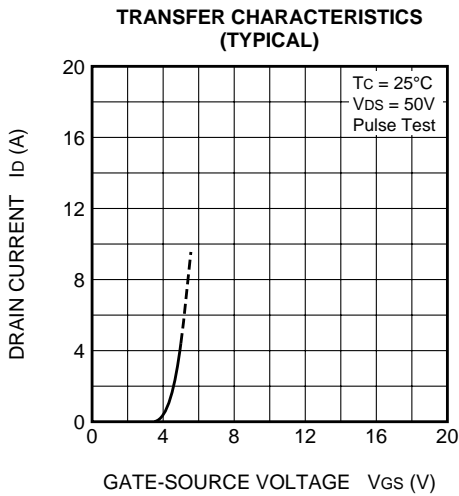
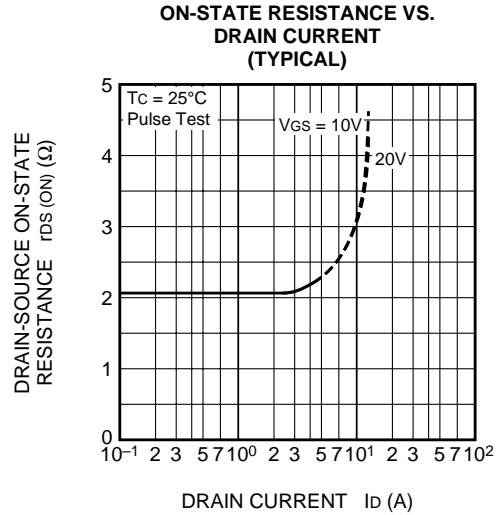
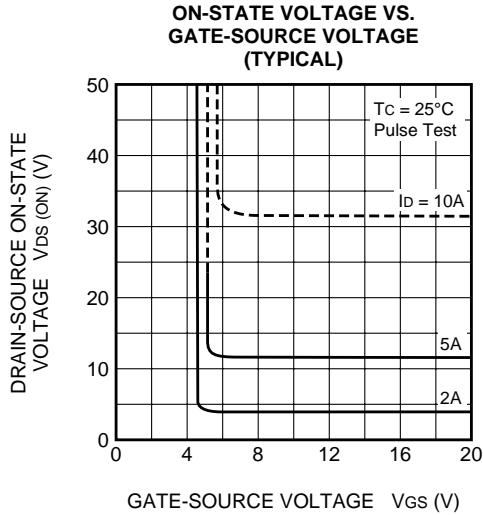

# FS5VS-18A

HIGH-SPEED SWITCHING USE

