

MITSUBISHI Nch POWER MOSFET

# FS70SMJ-03

HIGH-SPEED SWITCHING USE

**FS70SMJ-03**

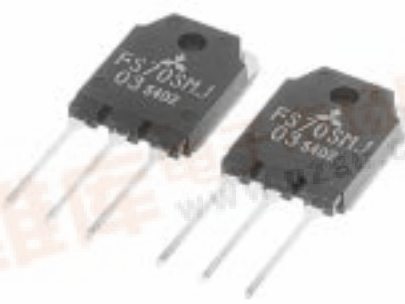

- 4V DRIVE
- V<sub>DSS</sub> ..... 30V
- r<sub>DS</sub> (ON) (MAX) ..... 12mΩ
- I<sub>D</sub> ..... 70A
- Integrated Fast Recovery Diode (TYP.) ..... 70ns

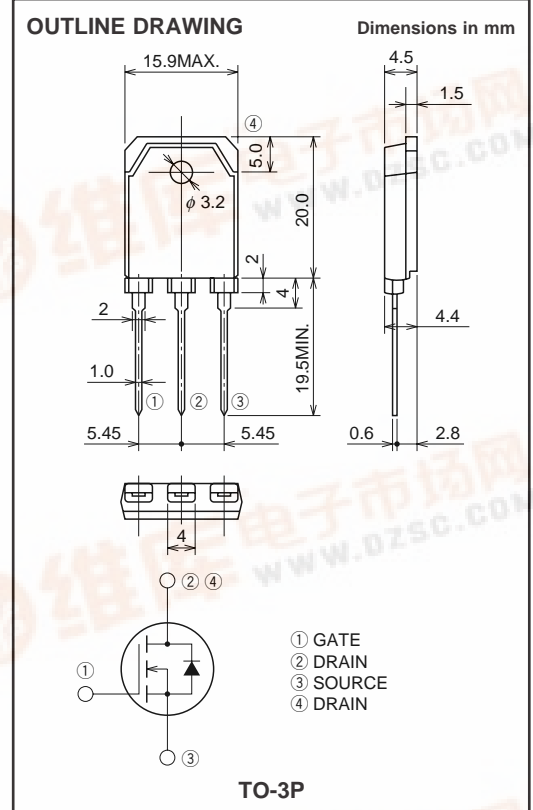

## APPLICATION

Motor control, Lamp control, Solenoid control  
DC-DC converter, etc.

## MAXIMUM RATINGS (T<sub>c</sub> = 25°C)

Symbol	Parameter	Conditions	Ratings	Unit
V <sub>DSS</sub>	Drain-source voltage	V <sub>GS</sub> = 0V	30	V
V <sub>GSS</sub>	Gate-source voltage	V <sub>DS</sub> = 0V	±20	V
I <sub>D</sub>	Drain current		70	A
I <sub>DM</sub>	Drain current (Pulsed)		280	A
I <sub>DA</sub>	Avalanche drain current (Pulsed)	L = 30μH	70	A
I <sub>S</sub>	Source current		70	A
I <sub>SM</sub>	Source current (Pulsed)		280	A
P <sub>D</sub>	Maximum power dissipation		70	W
T <sub>ch</sub>	Channel temperature		-55 ~ +150	°C
T <sub>stg</sub>	Storage temperature		-55 ~ +150	°C
—	Weight	Typical value	4.8	g

# FS70SMJ-03

## HIGH-SPEED SWITCHING USE

### ELECTRICAL CHARACTERISTICS (Tch = 25°C)

Symbol	Parameter	Test conditions	Limits			Unit
			Min.	Typ.	Max.	
V(BR)DSS	Drain-source breakdown voltage	Id = 1mA, VGS = 0V	30	—	—	V
IGSS	Gate-source leakage current	VGS = ±20V, VDS = 0V	—	—	±0.1	μA
IDSS	Drain-source leakage current	VDS = 30V, VGS = 0V	—	—	0.1	mA
VGS(th)	Gate-source threshold voltage	Id = 1mA, VDS = 10V	1.0	1.5	2.0	V
rDS(ON)	Drain-source on-state resistance	Id = 35A, VGS = 10V	—	9	12	mΩ
rDS(ON)	Drain-source on-state resistance	Id = 35A, VGS = 4V	—	13	22	mΩ
VDS(ON)	Drain-source on-state voltage	Id = 35A, VGS = 10V	—	0.32	0.42	V
yfs	Forward transfer admittance	Id = 35A, VDS = 10V	—	50	—	S
Ciss	Input capacitance	VDS = 10V, VGS = 0V, f = 1MHz	—	2850	—	pF
Coss	Output capacitance		—	800	—	pF
Crss	Reverse transfer capacitance		—	450	—	pF
td(on)	Turn-on delay time	VDD = 15V, Id = 35A, VGS = 10V, RGEN = RGS = 50Ω	—	25	—	ns
tr	Rise time		—	125	—	ns
td(off)	Turn-off delay time		—	250	—	ns
tf	Fall time		—	210	—	ns
VSD	Source-drain voltage	Is = 35A, VGS = 0V	—	1.0	1.5	V
Rth(ch-c)	Thermal resistance	Channel to case	—	—	1.76	°C/W
trr	Reverse recovery time	Is = 35A, dis/dt = -50A/μs	—	70	—	ns

### PERFORMANCE CURVES

POWER DISSIPATION DERATING CURVE

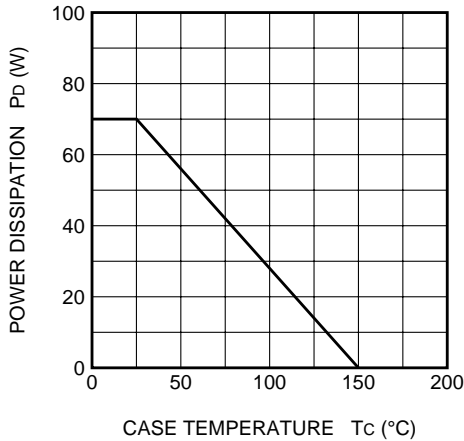

MAXIMUM SAFE OPERATING AREA

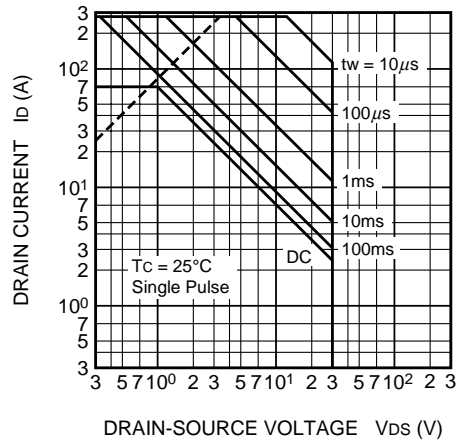

OUTPUT CHARACTERISTICS (TYPICAL)

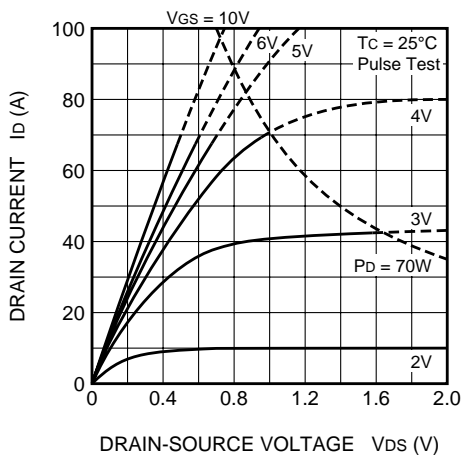

OUTPUT CHARACTERISTICS (TYPICAL)

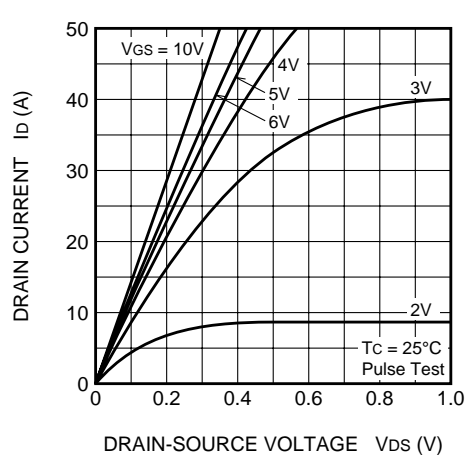

# FS70SMJ-03

HIGH-SPEED SWITCHING USE

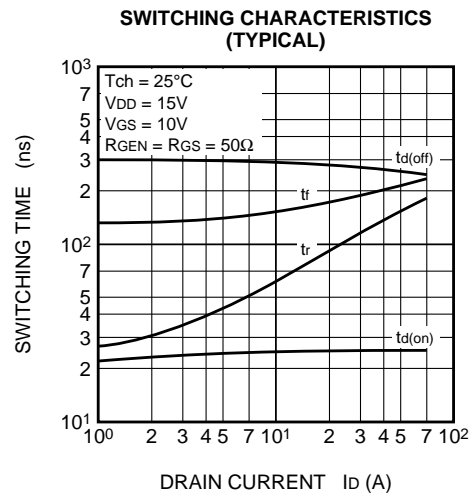
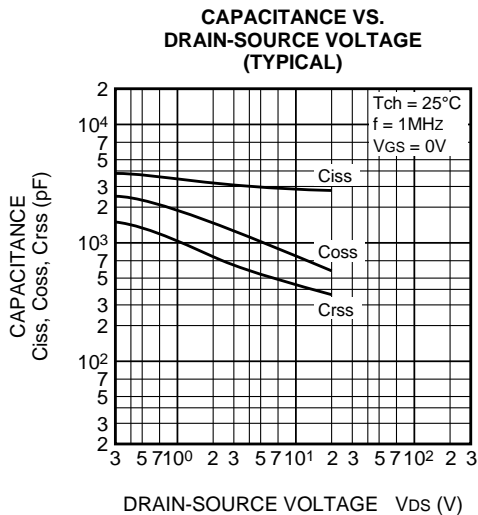
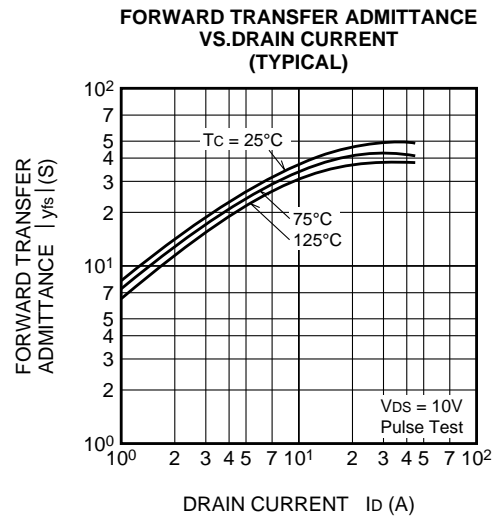
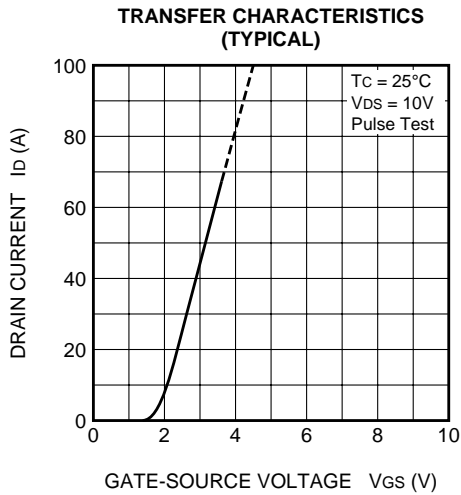
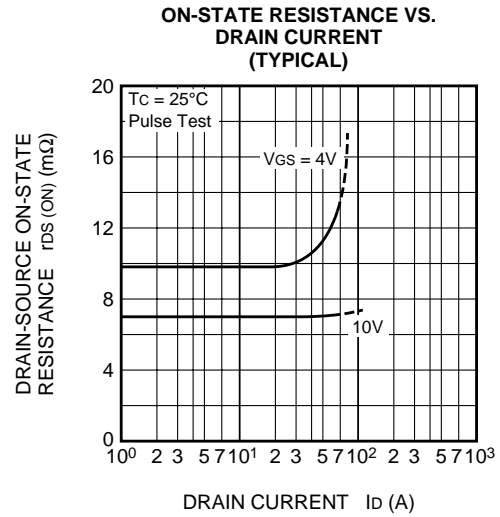
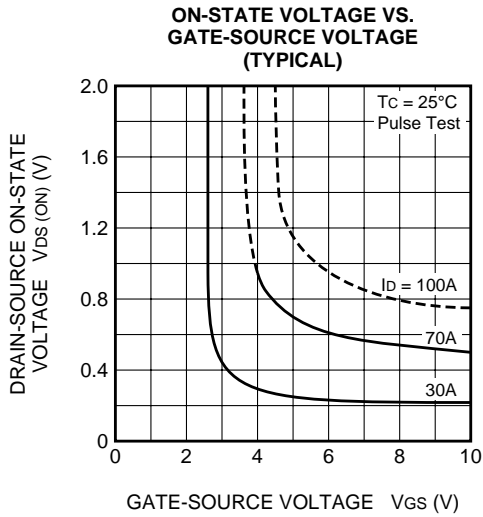

FS70SMJ-03

HIGH-SPEED SWITCHING USE

