

MITSUBISHI Nch POWER MOSFET

FS7SM-18A

HIGH-SPEED SWITCHING USE

FS7SM-18A



- V_{DSS} 900V
- r_{DS (ON)} (MAX) 2.0Ω
- I_D 7A

OUTLINE DRAWING Dimensions in mm

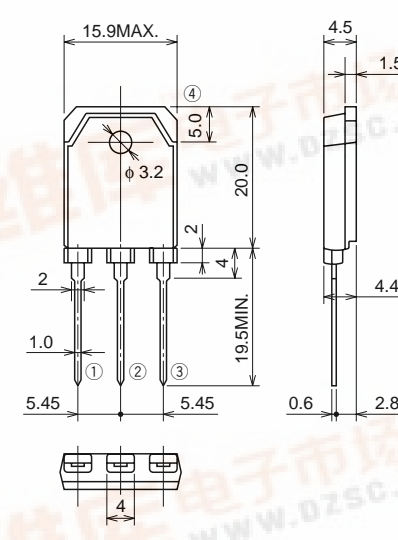

① GATE
② DRAIN
③ SOURCE
④ DRAIN

TO-3P

APPLICATION

SMPS, DC-DC Converter, battery charger, power supply of printer, copier, HDD, FDD, TV, VCR, personal computer etc.

MAXIMUM RATINGS (T_c = 25°C)

Symbol	Parameter	Conditions	Ratings	Unit
V _{DSS}	Drain-source voltage	V _{GS} = 0V	900	V
V _{GSS}	Gate-source voltage	V _{DS} = 0V	±30	V
I _D	Drain current		7	A
I _{DM}	Drain current (Pulsed)		21	A
P _D	Maximum power dissipation		150	W
T _{ch}	Channel temperature		-55 ~ +150	°C
T _{stg}	Storage temperature		-55 ~ +150	°C
—	Weight	Typical value	4.8	g



FS7SM-18A

HIGH-SPEED SWITCHING USE

ELECTRICAL CHARACTERISTICS (T_{ch} = 25°C)

Symbol	Parameter	Test conditions	Limits			Unit
			Min.	Typ.	Max.	
V(BR)DSS	Drain-source breakdown voltage	I _D = 1mA, V _{GS} = 0V	900	—	—	V
V(BR)GSS	Gate-source breakdown voltage	I _{GS} = ±100μA, V _{DS} = 0V	±30	—	—	V
I _{GSS}	Gate-source leakage current	V _{GS} = ±25V, V _{DS} = 0V	—	—	±10	μA
I _{DSS}	Drain-source leakage current	V _{DS} = 900V, V _{GS} = 0V	—	—	1	mA
V _{GS(th)}	Gate-source threshold voltage	I _D = 1mA, V _{DS} = 10V	2	3	4	V
r _{DS(ON)}	Drain-source on-state resistance	I _D = 3A, V _{GS} = 10V	—	1.54	2.00	Ω
V _{DS(ON)}	Drain-source on-state voltage	I _D = 3A, V _{GS} = 10V	—	4.62	6.00	V
y _{fs}	Forward transfer admittance	I _D = 3A, V _{DS} = 10V	4.2	7.0	—	S
C _{iss}	Input capacitance	V _{DS} = 25V, V _{GS} = 0V, f = 1MHz	—	1380	—	pF
C _{oss}	Output capacitance		—	140	—	pF
C _{rss}	Reverse transfer capacitance		—	28	—	pF
t _{d(on)}	Turn-on delay time	V _{DD} = 200V, I _D = 3A, V _{GS} = 10V, R _{GEN} = R _{GS} = 50Ω	—	25	—	ns
t _r	Rise time		—	28	—	ns
t _{d(off)}	Turn-off delay time		—	185	—	ns
t _f	Fall time		—	46	—	ns
V _{SD}	Source-drain voltage		I _S = 3A, V _{GS} = 0V	—	1.0	1.5
R _{th(ch-c)}	Thermal resistance	Channel to case	—	—	0.83	°C/W

PERFORMANCE CURVES

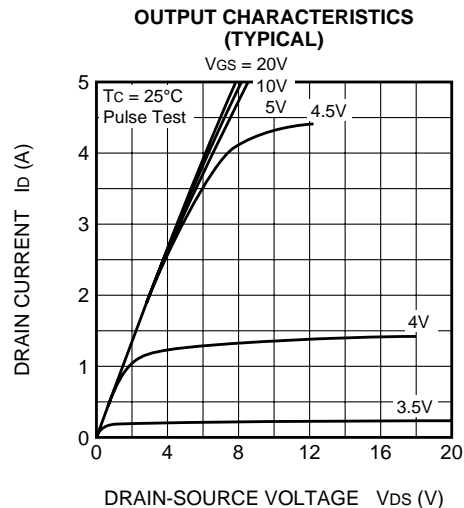
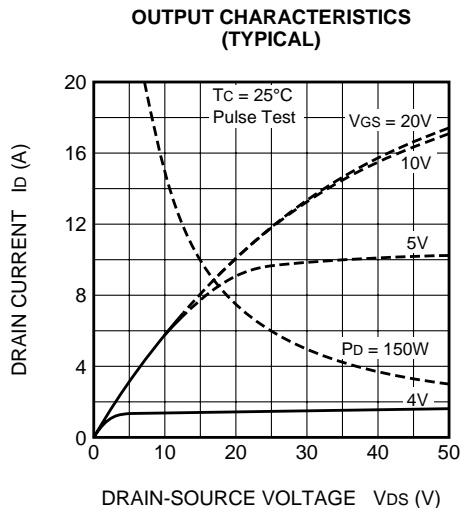
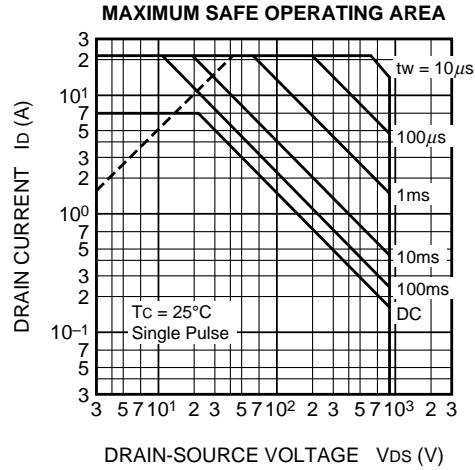
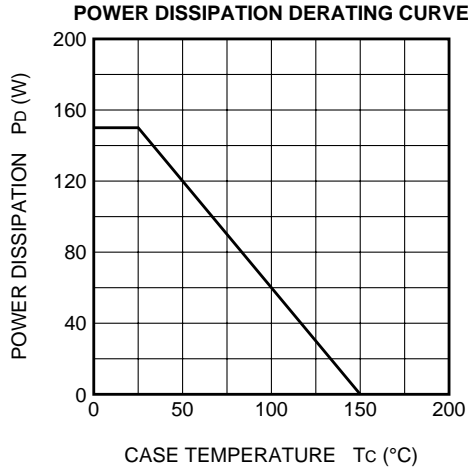

FS7SM-18A

HIGH-SPEED SWITCHING USE

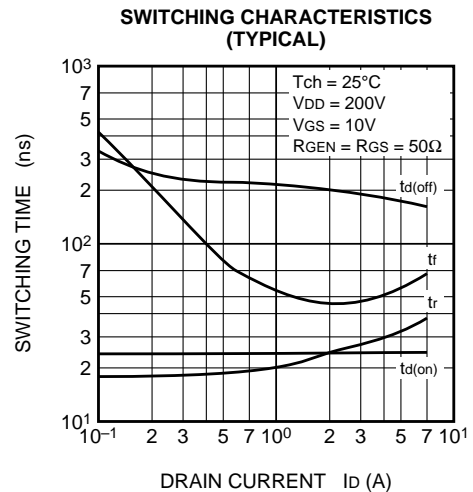
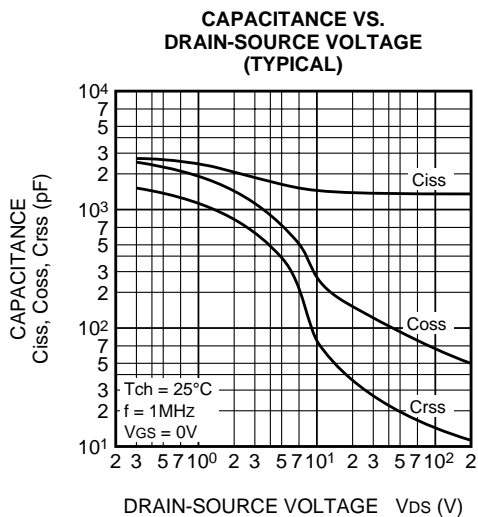
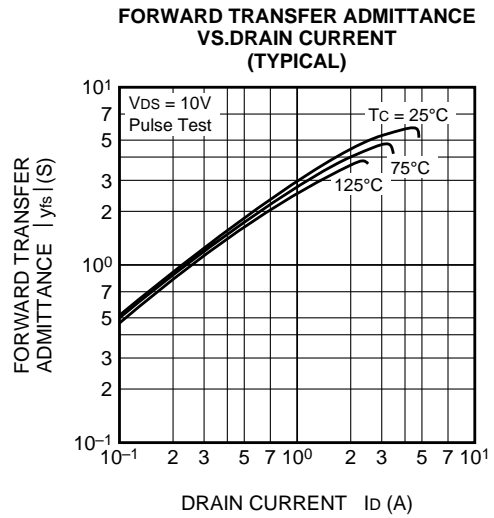
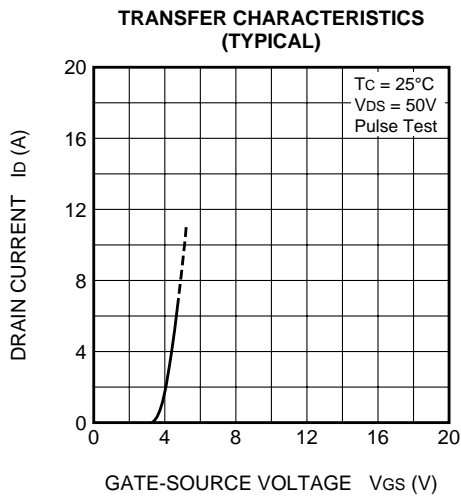
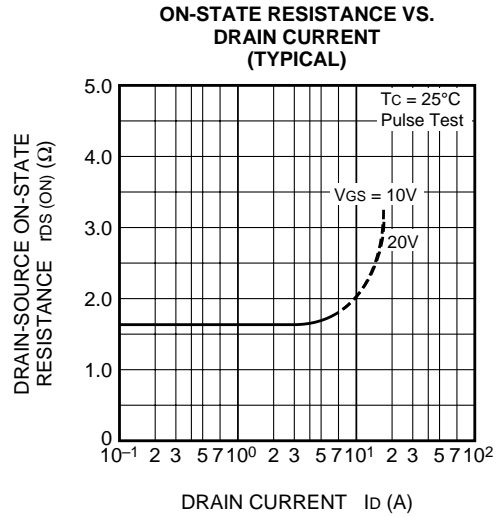
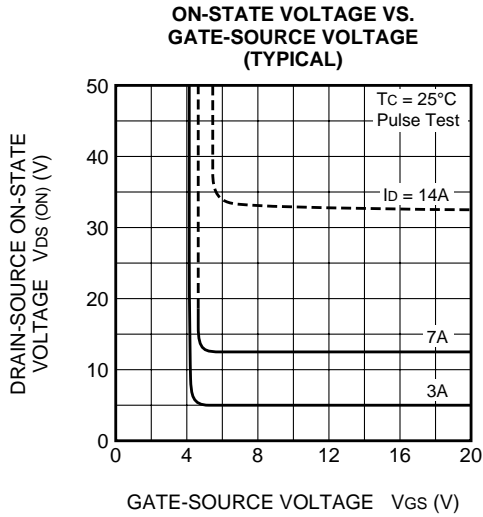

FS7SM-18A

HIGH-SPEED SWITCHING USE

