

SBD Type : FSH10A06B

OUTLINE DRAWING

FEATURES

- *Similar to TO-220AB Case
- *Fully Molded Isolation
- *Low Forward Voltage Drop
- *Low Power Loss,High Efficiency
- *High Surge Capability
- *Tj=150 °C operation

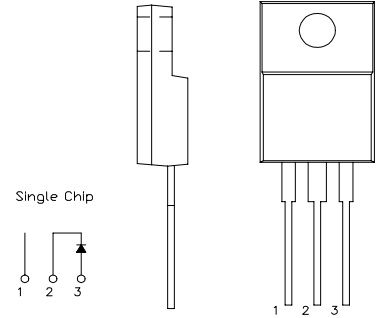

Maximum Ratings

Approx Net Weight: 1.75g

Rating	Symbol	FSH10A06B		Unit
Repetitive Peak Reverse Voltage	V_{RRM}	60		V
Repetitive Peak Surge Reverse Voltage	V_{RRSM}	65(pulse width $\leq 1\mu s$ duty $\leq 1/50$)		V
Average Rectified Output Current	I_O	10	Tc=124°C 50 Hz half Sine Wave Resistive Load	A
RMS Forward Current	$I_{F(RMS)}$	15.7		A
Surge Forward Current	I_{FSM}	180	50Hz Half Sine Wave ,1cycle Non-repetitive	A
Operating JunctionTemperature Range	T_{jw}	-40 to +150		°C
Storage Temperature Range	T_{stg}	-40 to +150		°C
Mounting torque	F_{tor}	recommended torque = 0.5		N•m

Electrical • Thermal Characteristics

Characteristics	Symbol	Conditions	Min.	Typ.	Max.	Unit
Peak Reverse Current	I_{RM}	Tj= 25°C, $V_{RM}= V_{RRM}$	-	-	1	mA
Peak Forward Voltage	V_{FM}	Tj= 25°C, $I_{FM}= 10 A$	-	-	0.68	V
Thermal Resistance	$R_{th(j-c)}$	Junction to Case	-	-	3	°C /W
	$R_{th(c-f)}$	Cace to Fin	-	-	1.5	°C /W

FSH_A_B OUTLINE DRAWING (Dimensions in mm)

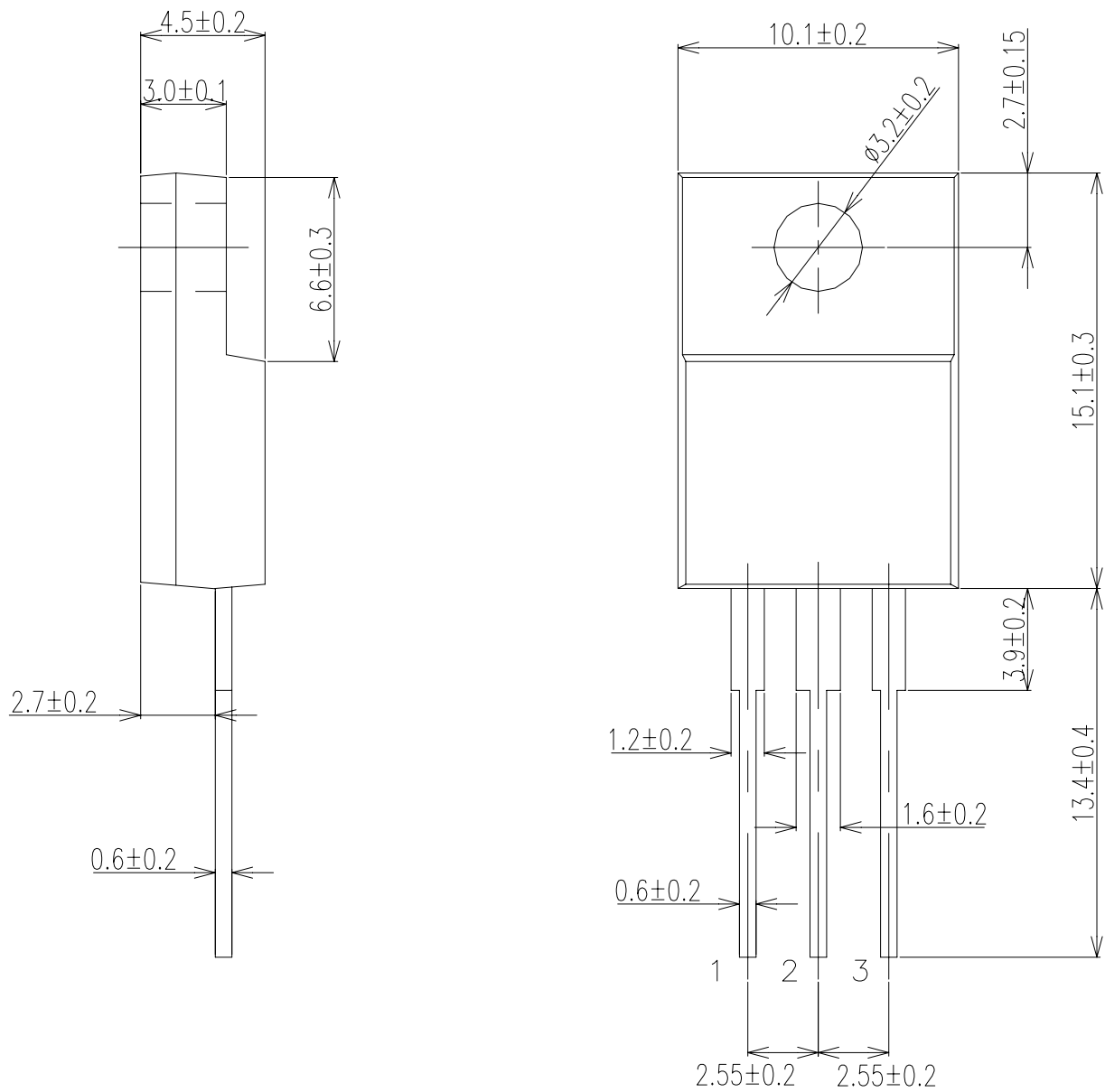

Single Chip

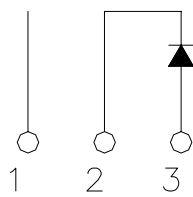

FORWARD CURRENT VS. VOLTAGE

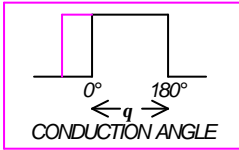
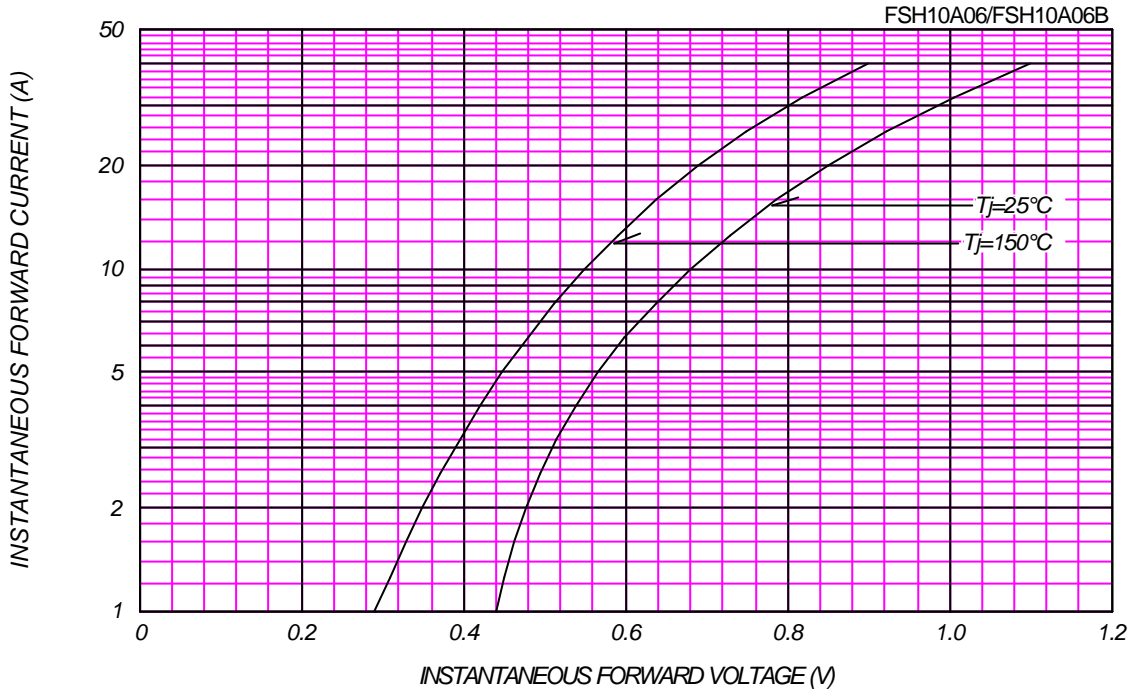

AVERAGE FORWARD POWER DISSIPATION

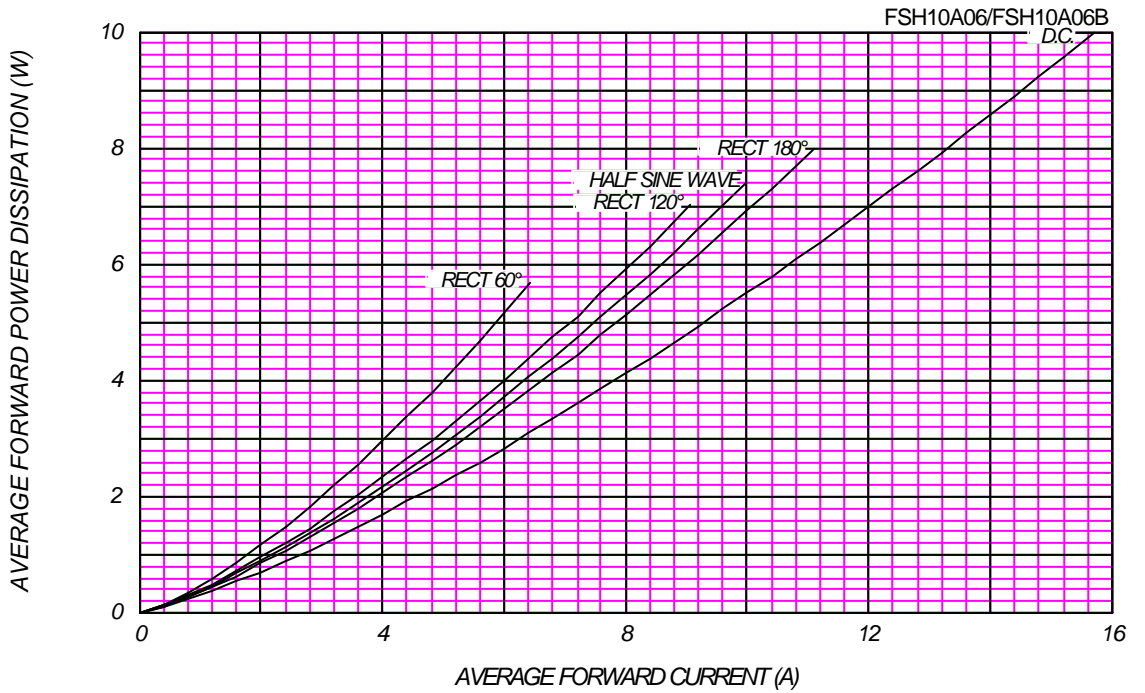

PEAK REVERSE CURRENT VS. PEAK REVERSE VOLTAGE

T_j = 150 °C

FSH10A06/FSH10A06B

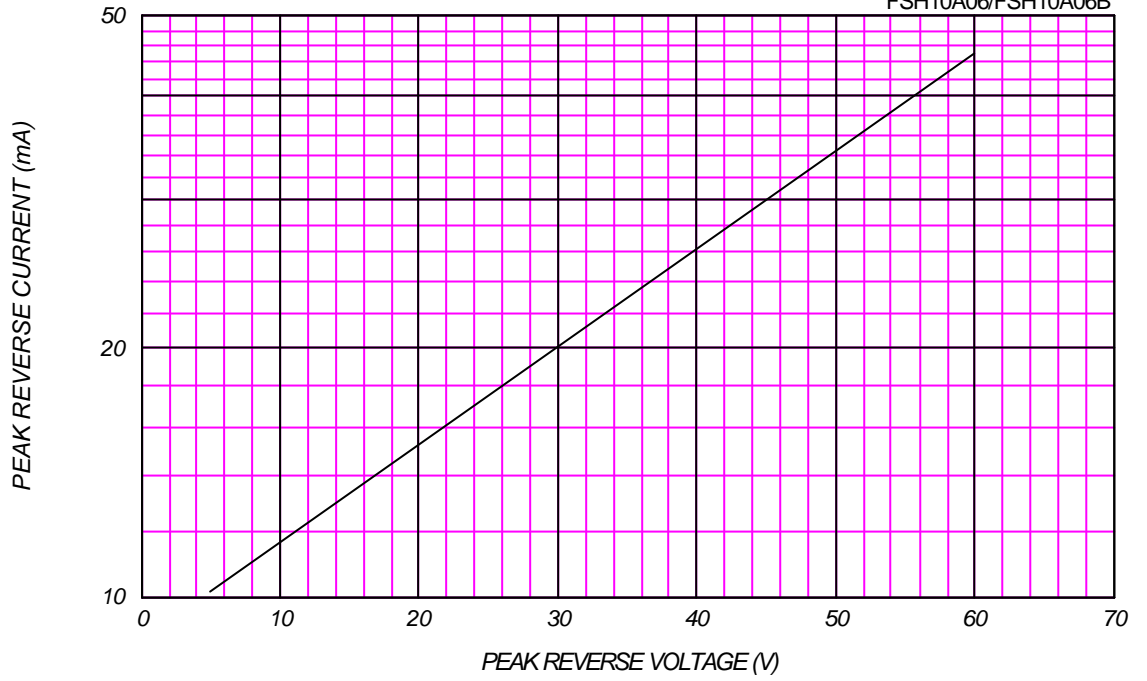

AVERAGE REVERSE POWER DISSIPATION

FSH10A06/FSH10A06B

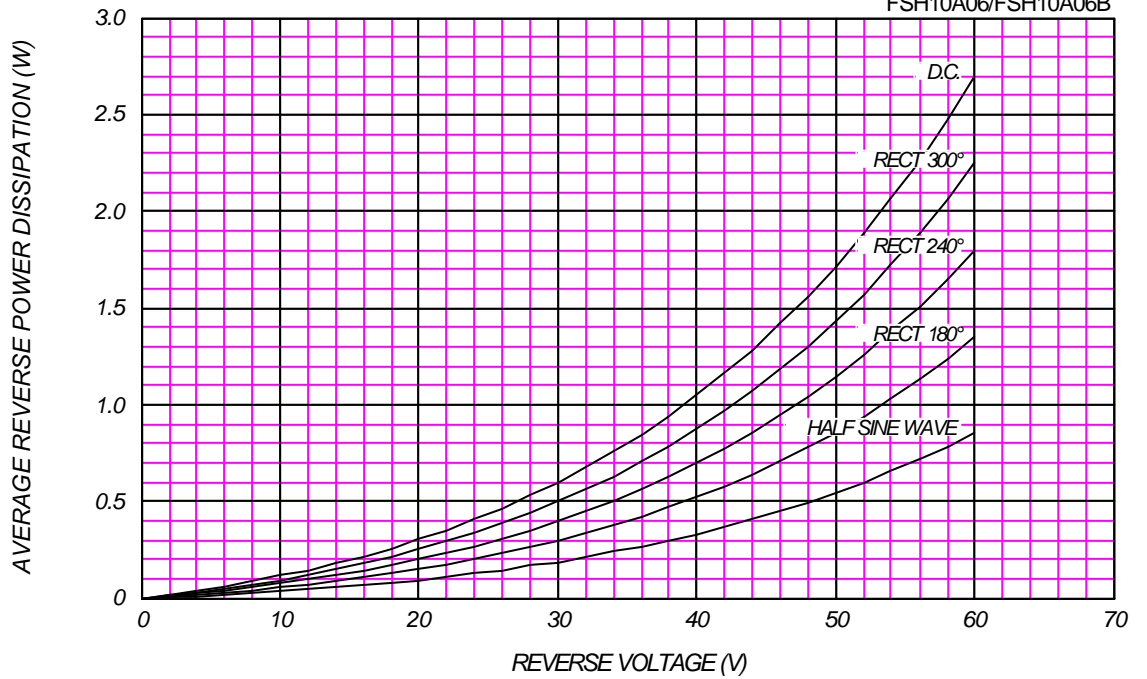

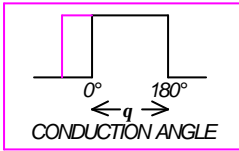

AVERAGE FORWARD CURRENT VS. CASE TEMPERATURE

$V_{RM}=60V$

FSH10A06/FSH10A06B

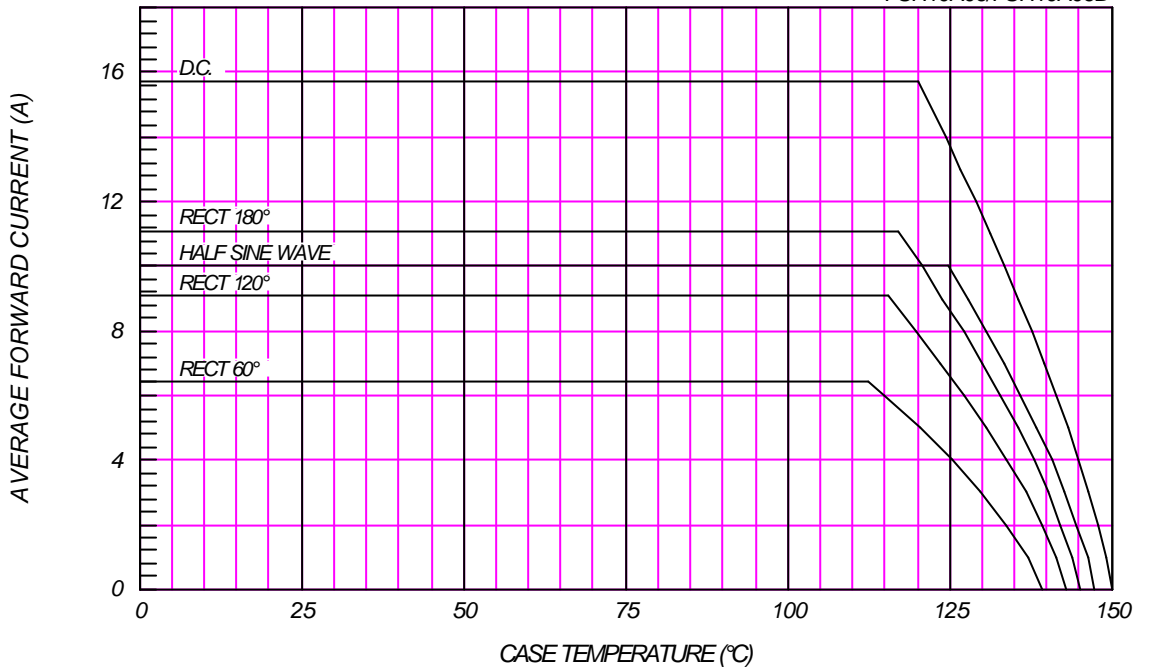

SURGE CURRENT RATINGS

$f=50Hz$, Half Sine Wave, Non-Repetitive, No Load

FSH10A06/FSH10A06B

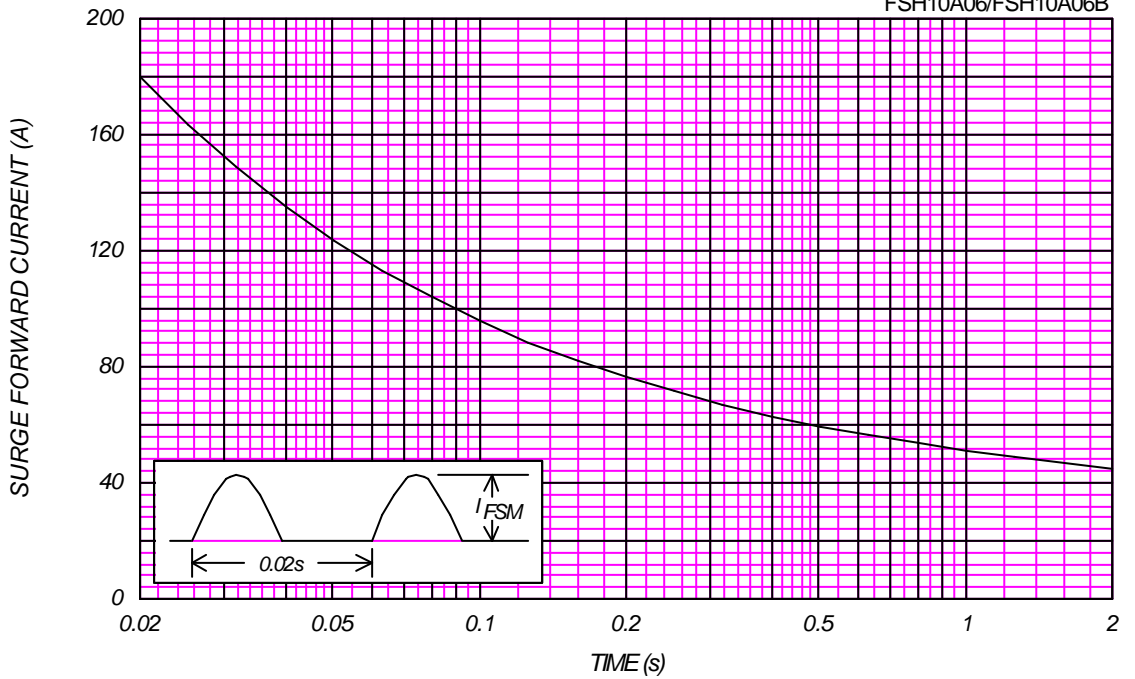

JUNCTION CAPACITANCE VS. REVERSE VOLTAGE

$T_j=25^\circ\text{C}$, $V_m=20\text{mV}_{\text{RMS}}$, $f=100\text{kHz}$, Typical Value

FSH10A06/FSH10A06B

