



**DC COMPONENTS CO., LTD.**  
RECTIFIER SPECIALISTS

**FSM101  
THRU  
FSM107**

**TECHNICAL SPECIFICATIONS OF SURFACE MOUNT FAST RECOVERY RECTIFIER**

**VOLTAGE RANGE - 50 to 1000 Volts**

**CURRENT - 1.0 Ampere**

**FEATURES**

- \* Ideal for surface mounted applications
- \* Low leakage current
- \* Fast switching for high efficiency
- \* Glass passivated junction

**MECHANICAL DATA**

- \* Case: Molded plastic
- \* Epoxy: UL 94V-0 rate flame retardant
- \* Terminals: Solder plated solderable per MIL-STD-202E, Method 208 guaranteed
- \* Polarity: Color band denotes cathode end
- \* Mounting position: Any
- \* Weight: 0.12 gram

**MAXIMUM RATINGS AND ELECTRICAL CHARACTERISTICS**

Ratings at 25 °C ambient temperature unless otherwise specified.  
Single phase, half wave, 60 Hz, resistive or inductive load.  
For capacitive load, derate current by 20%.



SM-1(DO-213AB)

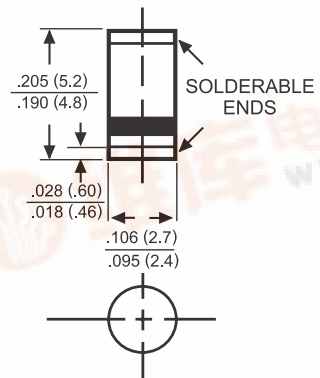

Dimensions in inches and (millimeters)

	SYMBOL	FSM101	FSM102	FSM103	FSM104	FSM105	FSM106	FSM107	UNITS
Maximum Recurrent Peak Reverse Voltage	VRRM	50	100	200	400	600	800	1000	Volts
Maximum RMS Voltage	VRMS	35	70	140	280	420	560	700	Volts
Maximum DC Blocking Voltage	Vbc	50	100	200	400	600	800	1000	Volts
Maximum Average Forward Rectified Current at TA = 55°C	Io	1.0							Amps
Peak Forward Surge Current 8.3 ms single half sine-wave superimposed on rated load (JEDEC Method)	IFSM	30							Amps
Maximum Forward Voltage at 1.0A DC	VF	1.3							Volts
Maximum DC Reverse Current at	IR	5.0							uAmps
Rated DC Blocking Voltage									
Maximum Reverse Recovery Time (Note 3)	trr	150			250	500			nSec
Maximum Thermal Resistance (Note 2)	RθJL	30							°C/W
Typical Junction Capacitance (Note 1)	CJ	15							pF
Operating and Storage Temperature Range	TJ, Tstg	-65 to + 175							°C

- NOTES : 1. Measured at 1.0 MHz and applied reverse voltage of 4.0VDC  
2. Thermal resistance (Junction to Ambient), .24in<sup>2</sup> (6.0mm<sup>2</sup>)copper pads to each terminal.  
3. Test Conditions: IF = 0.5A, IR = 1.0A, IRR = 0.25A



# RATING AND CHARACTERISTIC CURVES ( FSM101 THRU FSM107 )

FIG. 1 - TYPICAL FORWARD CURRENT DERATING CURVE

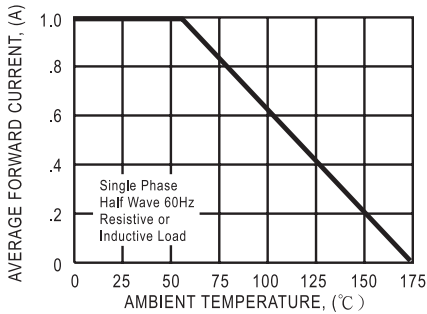

FIG. 2 - MAXIMUM NON-REPETITIVE FORWARD SURGE CURRENT

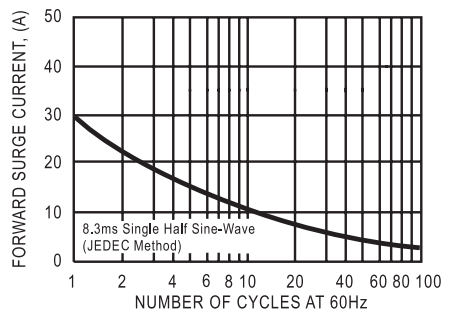

FIG. 3 - TYPICAL REVERSE CHARACTERISTICS

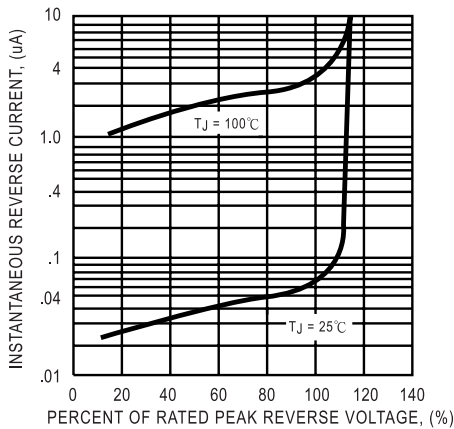

FIG. 4 - TYPICAL INSTANTANEOUS FORWARD CHARACTERISTICS

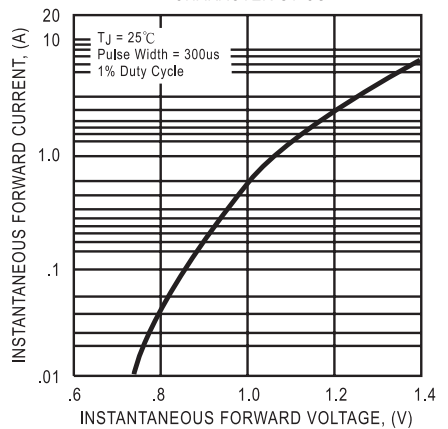
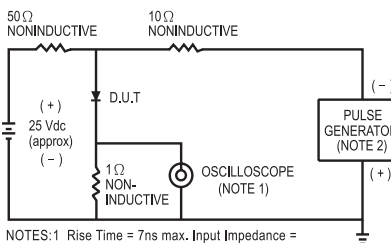

FIG. 5 - TEST CIRCUIT DIAGRAM AND REVERSE RECOVERY TIME CHARACTERISTIC



NOTES: 1. Rise Time = 7ns max. Input Impedance = 1 megohm. 22 pF.  
2. Rise Time = 10ns max. Source Impedance = 50 ohms.

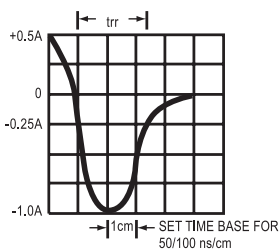

FIG. 6 - TYPICAL JUNCTION CAPACITANCE

