

International IR Rectifier

PD - 94523

IRFR3518
IRFU3518

HEXFET® Power MOSFET

Applications

- High frequency DC-DC converters

| V_{DS} | $R_{DS(on)}$ max | I_D |
|----------|------------------|-------|
| 80V | 29mΩ | 30A |

Benefits

- Low Gate-to-Drain Charge to Reduce Switching Losses
- Fully Characterized Capacitance Including Effective C_{OSS} to Simplify Design, (See App. Note AN1001)
- Fully Characterized Avalanche Voltage and Current

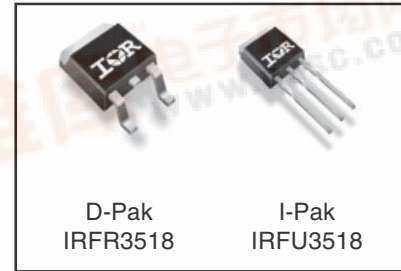

Absolute Maximum Ratings

| | Parameter | Max. | Units |
|---------------------------------|---|------------------------|-------|
| V_{DS} | Drain-to-Source Voltage | 80 | V |
| V_{GS} | Gate-to-Source Voltage | ± 20 | |
| $I_D @ T_C = 25^\circ\text{C}$ | Continuous Drain Current, $V_{GS} @ 10\text{V}$ | 38 | A |
| $I_D @ T_C = 100^\circ\text{C}$ | Continuous Drain Current, $V_{GS} @ 10\text{V}$ | 27 | |
| I_{DM} | Pulsed Drain Current ① | 150 | |
| $P_D @ T_C = 25^\circ\text{C}$ | Power Dissipation | 110 | W |
| | Linear Derating Factor | 0.71 | W/°C |
| dv/dt | Peak Diode Recovery dv/dt ③ | 5.2 | V/ns |
| T_J | Operating Junction and | -55 to + 175 | °C |
| T_{STG} | Storage Temperature Range | | |
| | Soldering Temperature, for 10 seconds | 300 (1.6mm from case) | |

Thermal Resistance

| | Parameter | Typ. | Max. | Units |
|-----------------|----------------------------------|------|------|-------|
| $R_{\theta JC}$ | Junction-to-Case | — | 1.4 | °C/W |
| $R_{\theta JA}$ | Junction-to-Ambient (PCB mount)④ | — | 40 | |
| $R_{\theta JA}$ | Junction-to-Ambient | — | 110 | |

Notes ① through ④ are on page 10

www.irf.com



IRFR3518/IRFU3518

International
IR Rectifier

Static @ T_J = 25°C (unless otherwise specified)

| | Parameter | Min. | Typ. | Max. | Units | Conditions |
|--------------------------------------|--------------------------------------|------|------|------|-------|---|
| V _{(BR)DSS} | Drain-to-Source Breakdown Voltage | 80 | — | — | V | V _{GS} = 0V, I _D = 250μA |
| ΔV _{(BR)DSS/ΔT_J} | Breakdown Voltage Temp. Coefficient | — | 0.09 | — | V/°C | Reference to 25°C, I _D = 1mA ⑥ |
| R _{DS(on)} | Static Drain-to-Source On-Resistance | — | 24 | 29 | mΩ | V _{GS} = 10V, I _D = 18A ④ |
| V _{GS(th)} | Gate Threshold Voltage | 2.0 | — | 4.0 | V | V _{DS} = V _{GS} , I _D = 250μA |
| I _{DSS} | Drain-to-Source Leakage Current | — | — | 20 | μA | V _{DS} = 80V, V _{GS} = 0V |
| | | — | — | 250 | | V _{DS} = 64V, V _{GS} = 0V, T _J = 150°C |
| I _{GSS} | Gate-to-Source Forward Leakage | — | — | 200 | nA | V _{GS} = 20V |
| | Gate-to-Source Reverse Leakage | — | — | -200 | | V _{GS} = -20V |

Dynamic @ T_J = 25°C (unless otherwise specified)

| | Parameter | Min. | Typ. | Max. | Units | Conditions |
|-----------------------|---------------------------------|------|------|------|-------|--|
| g _{fs} | Forward Transconductance | 34 | — | — | S | V _{DS} = 25V, I _D = 18A |
| Q _g | Total Gate Charge | — | 37 | 56 | nC | I _D = 18A |
| Q _{gs} | Gate-to-Source Charge | — | 11 | — | | V _{DS} = 40V |
| Q _{gd} | Gate-to-Drain ("Miller") Charge | — | 12 | — | | V _{GS} = 10V ④ |
| t _{d(on)} | Turn-On Delay Time | — | 12 | — | ns | V _{DD} = 40V |
| t _r | Rise Time | — | 25 | — | | I _D = 18A |
| t _{d(off)} | Turn-Off Delay Time | — | 37 | — | | R _G = 9.1Ω |
| t _f | Fall Time | — | 13 | — | | V _{GS} = 10V ④ |
| C _{iss} | Input Capacitance | — | 1710 | — | pF | V _{GS} = 0V |
| C _{oss} | Output Capacitance | — | 270 | — | | V _{DS} = 25V |
| C _{rss} | Reverse Transfer Capacitance | — | 33 | — | | f = 1.0MHz |
| C _{oss} | Output Capacitance | — | 1780 | — | | V _{GS} = 0V, V _{DS} = 1.0V, f = 1.0MHz |
| C _{oss} | Output Capacitance | — | 170 | — | | V _{GS} = 0V, V _{DS} = 64V, f = 1.0MHz |
| C _{oss eff.} | Effective Output Capacitance | — | 330 | — | | V _{GS} = 0V, V _{DS} = 0V to 64V ⑤ |
| | | | | | | |

Avalanche Characteristics

| | Parameter | Typ. | Max. | Units |
|-----------------|--------------------------------|------|------|-------|
| E _{AS} | Single Pulse Avalanche Energy② | — | 160 | mJ |
| I _{AR} | Avalanche Current① | — | 18 | A |
| E _{AR} | Repetitive Avalanche Energy① | — | 11 | mJ |

Diode Characteristics

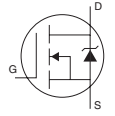
| | Parameter | Min. | Typ. | Max. | Units | Conditions |
|-----------------|--|--|------|------|-------|--|
| I _S | Continuous Source Current (Body Diode) | — | — | 38 | A | MOSFET symbol showing the integral reverse p-n junction diode.  |
| I _{SM} | Pulsed Source Current (Body Diode) ① | — | — | 150 | | |
| V _{SD} | Diode Forward Voltage | — | — | 1.3 | V | T _J = 25°C, I _S = 18A, V _{GS} = 0V ④ |
| t _{rr} | Reverse Recovery Time | — | 77 | — | ns | T _J = 25°C, I _F = 18A |
| Q _{rr} | Reverse Recovery Charge | — | 210 | — | nC | di/dt = 100A/μs ④ |
| t _{on} | Forward Turn-On Time | Intrinsic turn-on time is negligible (turn-on is dominated by L _S +L _D) | | | | |

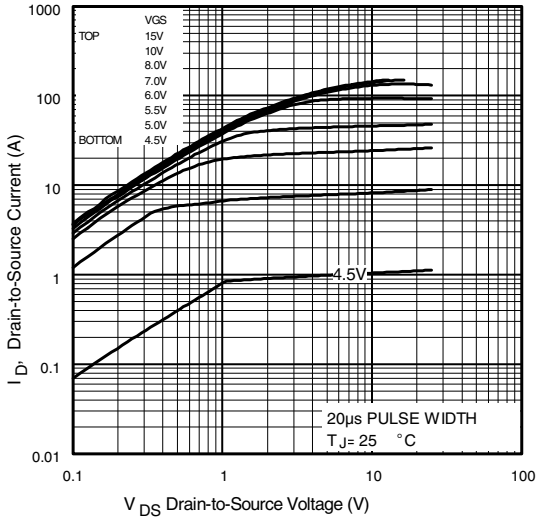

Fig 1. Typical Output Characteristics

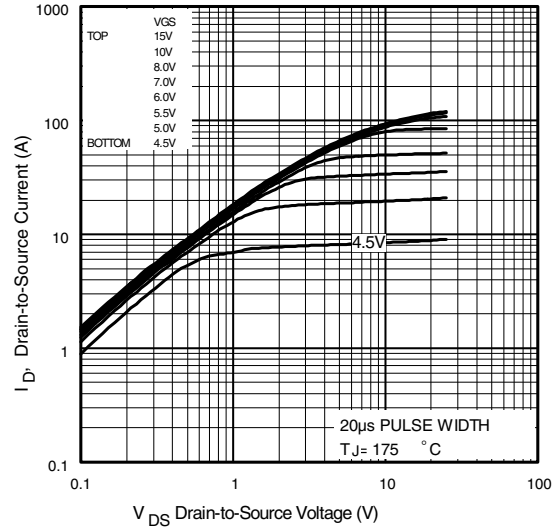

Fig 2. Typical Output Characteristics

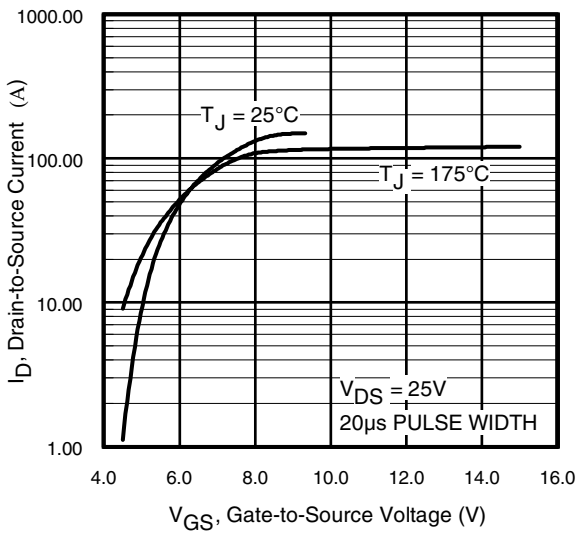

Fig 3. Typical Transfer Characteristics

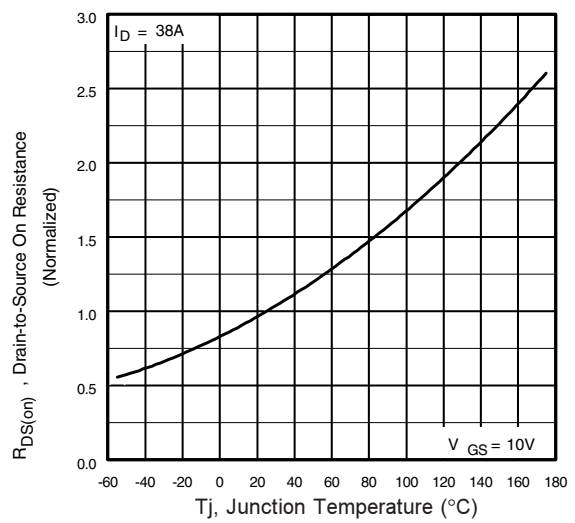

Fig 4. Normalized On-Resistance Vs. Temperature

IRFR3518/IRFU3518

International
IR Rectifier

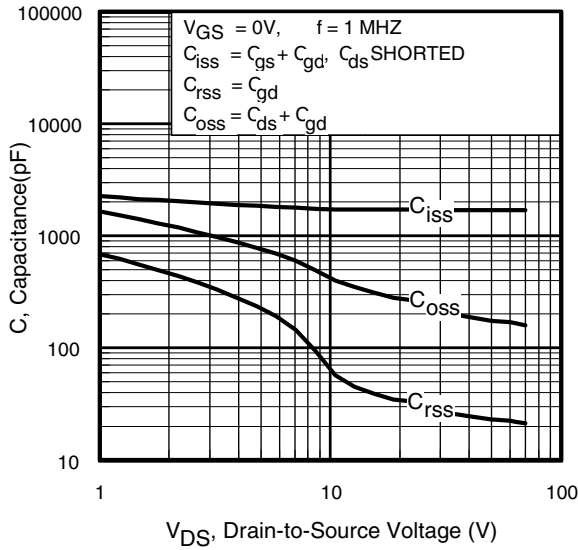

Fig 5. Typical Capacitance Vs. Drain-to-Source Voltage

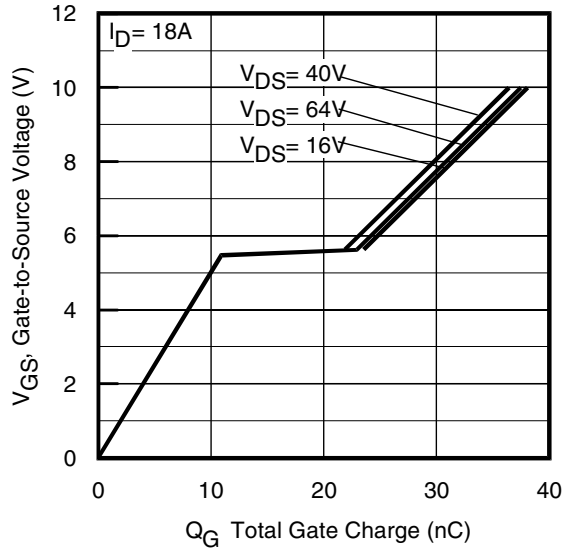

Fig 6. Typical Gate Charge Vs. Gate-to-Source Voltage

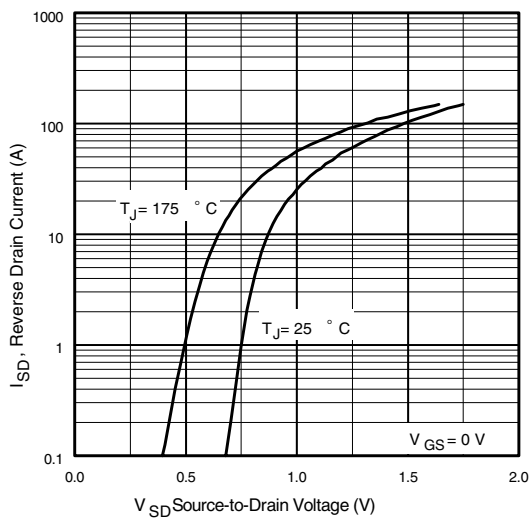

Fig 7. Typical Source-Drain Diode Forward Voltage

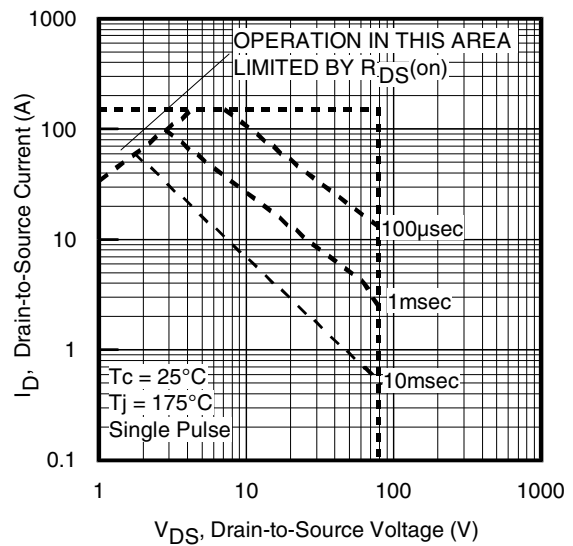

Fig 8. Maximum Safe Operating Area

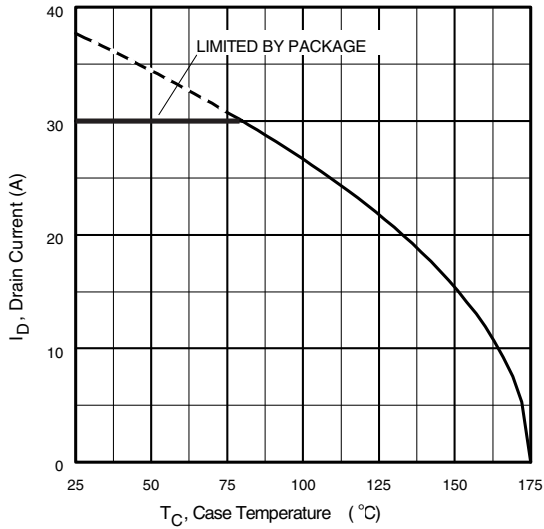

Fig 9. Maximum Drain Current Vs. Case Temperature

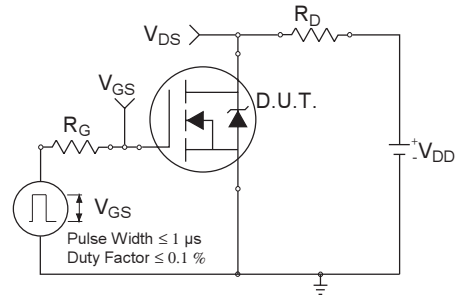

Fig 10a. Switching Time Test Circuit

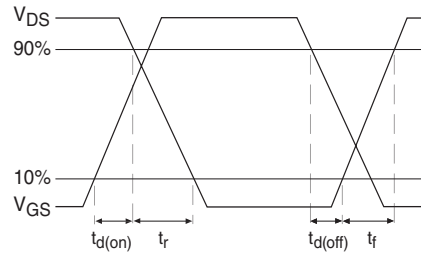

Fig 10b. Switching Time Waveforms

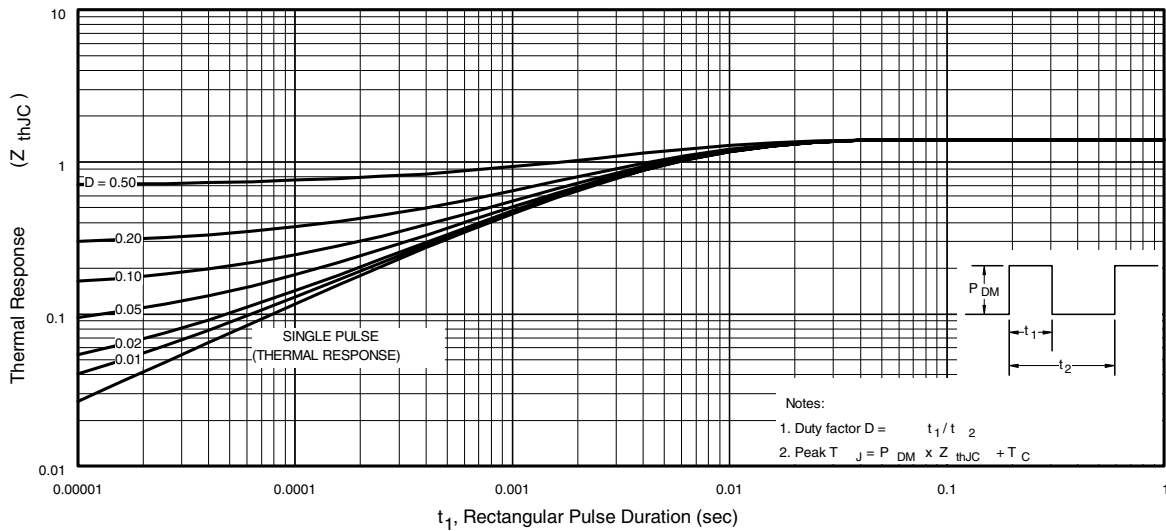

Fig 11. Maximum Effective Transient Thermal Impedance, Junction-to-Case

IRFR3518/IRFU3518

International
IR Rectifier

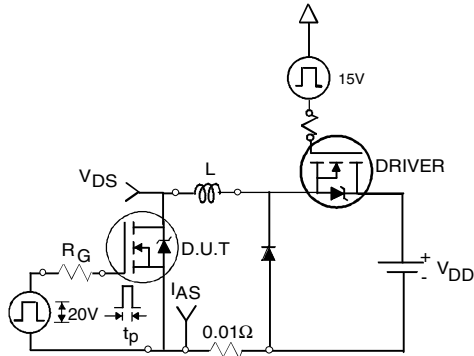

Fig 12a. Unclamped Inductive Test Circuit

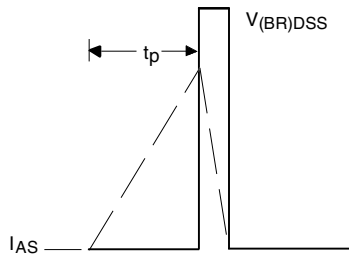

Fig 12b. Unclamped Inductive Waveforms

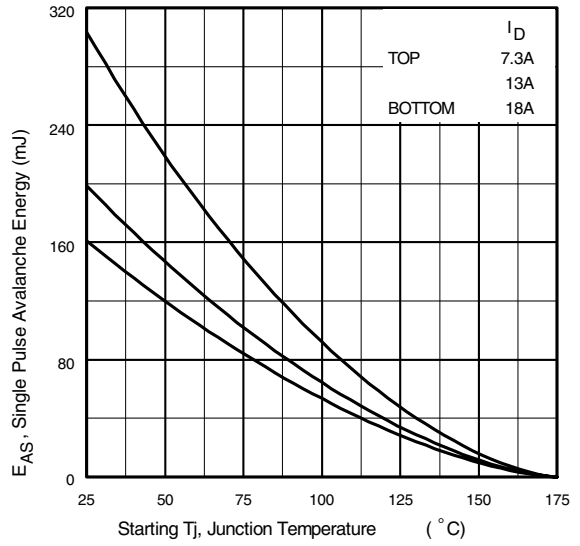

Fig 12c. Maximum Avalanche Energy Vs. Drain Current

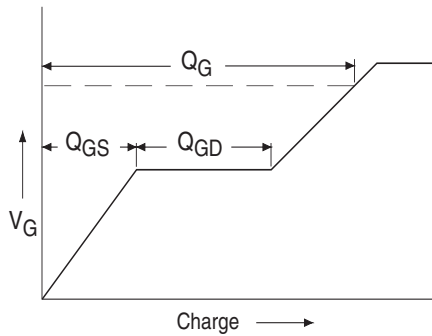

Fig 13a. Basic Gate Charge Waveform

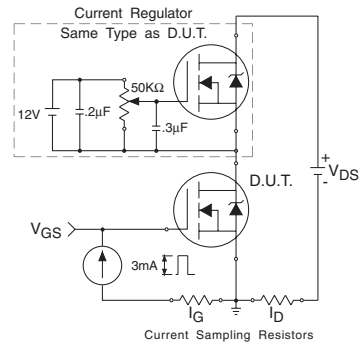
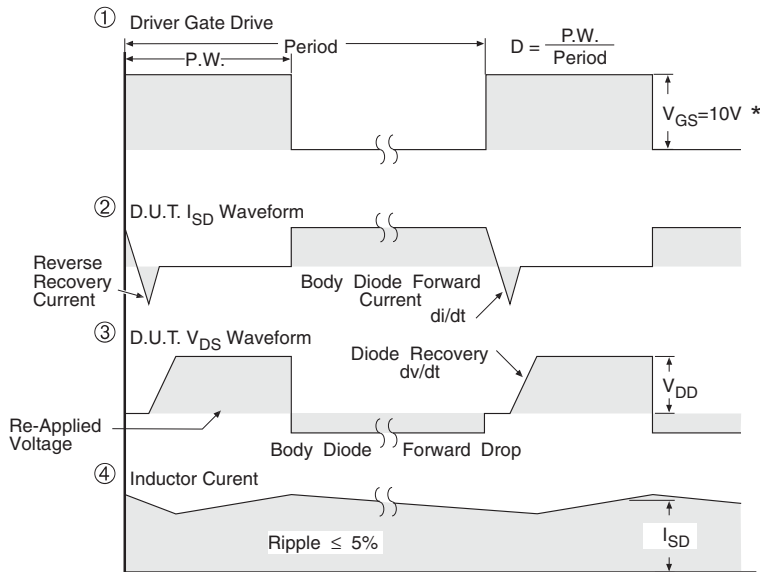
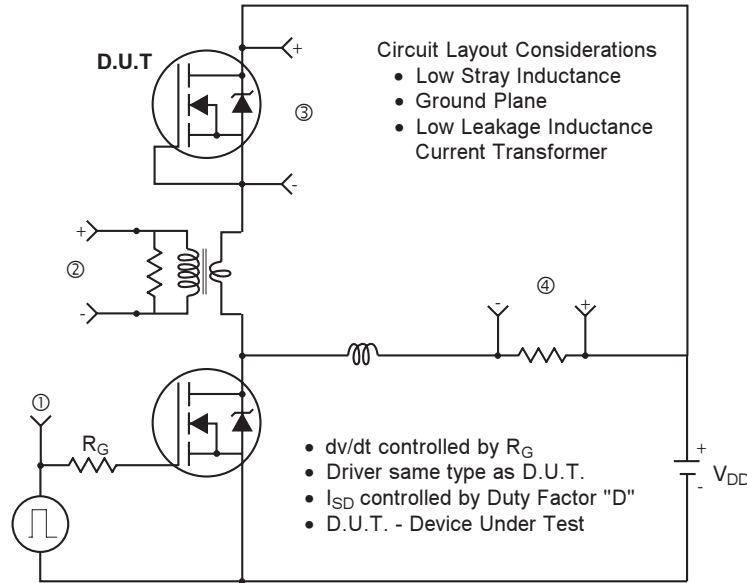

Fig 13b. Gate Charge Test Circuit

Peak Diode Recovery dv/dt Test Circuit



* $V_{GS} = 5V$ for Logic Level Devices

Fig 14. For N-Channel HEXFET® Power MOSFETs

IRFR3518/IRFU3518



D-Pak (TO-252AA) Package Outline

Dimensions are shown in millimeters (inches)

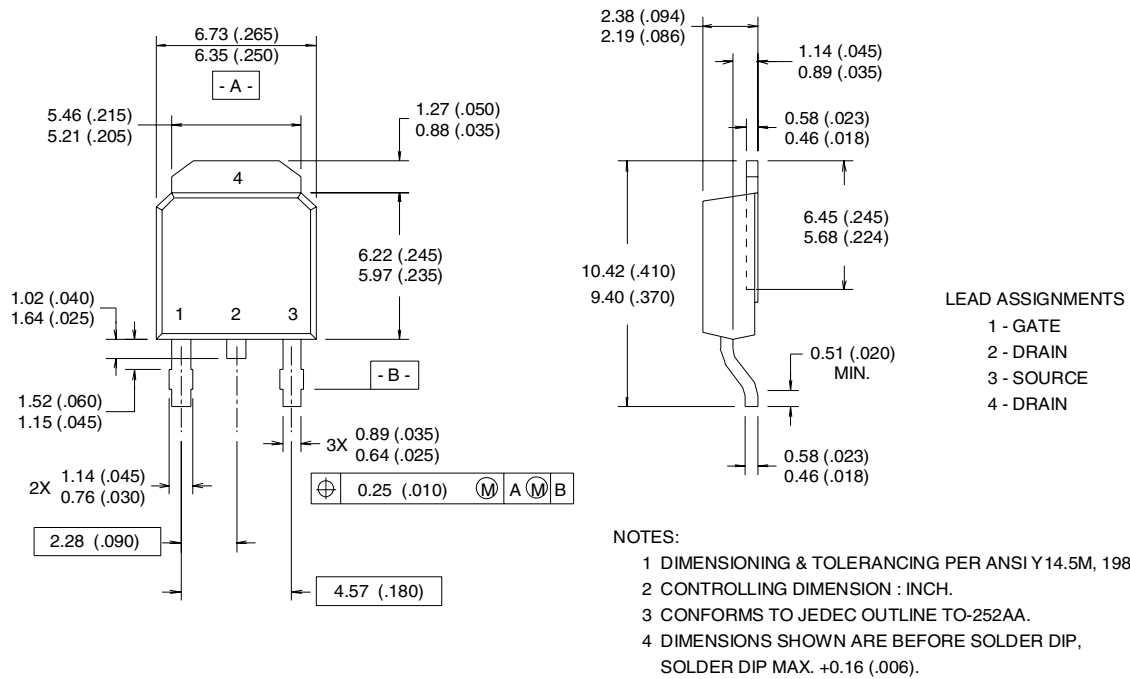

D-Pak (TO-252AA) Part Marking Information

EXAMPLE: THIS IS AN IRFR120
 LOT CODE 1789
 ASSEMBLED ON WW 19, 1997
 IN THE ASSEMBLY LINE "C"

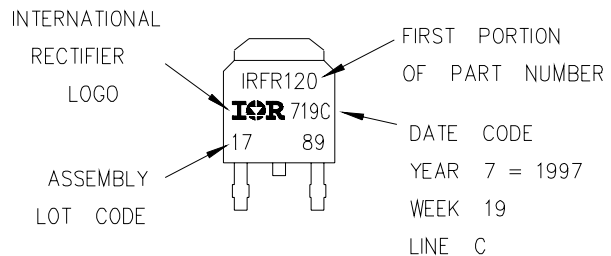

I-Pak (TO-251AA) Package Outline

Dimensions are shown in millimeters (inches)

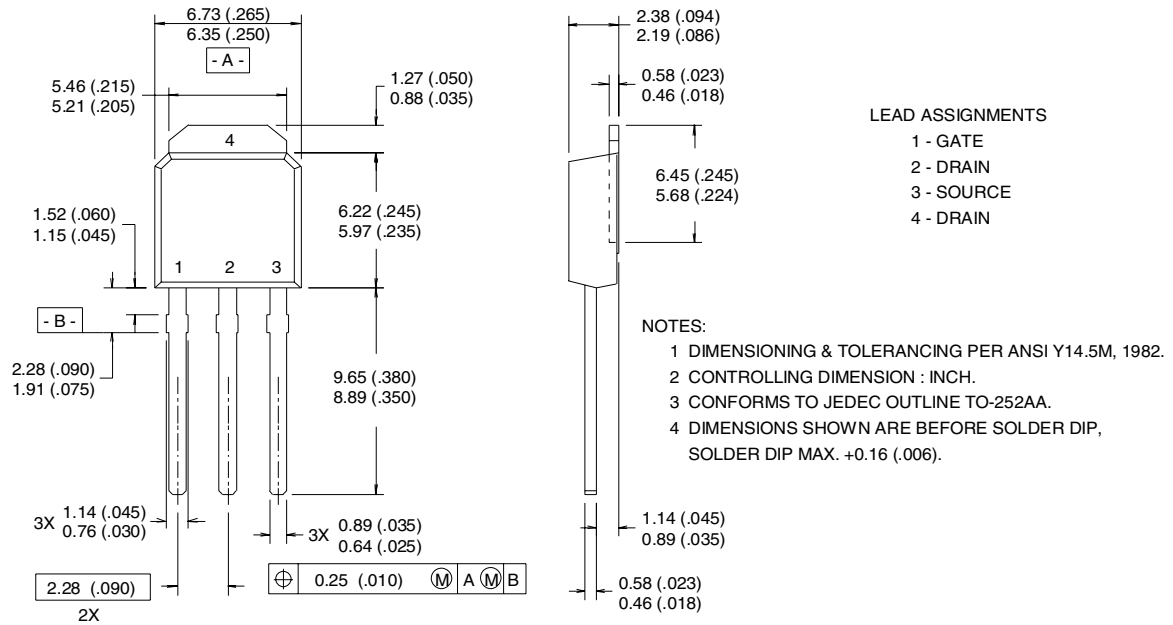

I-Pak (TO-251AA) Part Marking Information

EXAMPLE: THIS IS AN IRFU120
 LOT CODE 1789
 ASSEMBLED ON WW 19, 1997
 IN THE ASSEMBLY LINE "C"

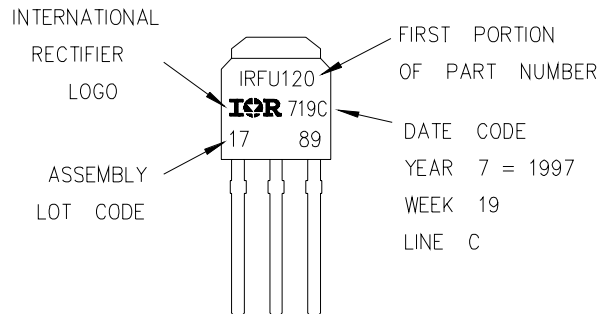

IRFR3518/IRFU3518

International
IR Rectifier

D-Pak (TO-252AA) Tape & Reel Information

Dimensions are shown in millimeters (inches)

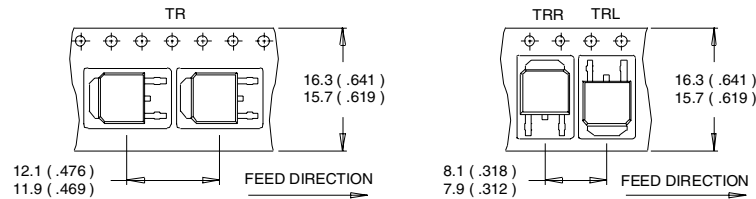

NOTES :

1. CONTROLLING DIMENSION : MILLIMETER.
2. ALL DIMENSIONS ARE SHOWN IN MILLIMETERS (INCHES).
3. OUTLINE CONFORMS TO EIA-481 & EIA-541.

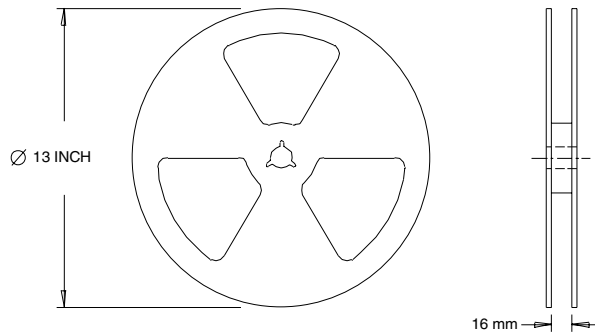

NOTES :

1. OUTLINE CONFORMS TO EIA-481.

Notes:

- ① Repetitive rating; pulse width limited by max. junction temperature.
- ② Starting $T_J = 25^\circ\text{C}$, $L = 0.99\text{mH}$
 $R_G = 25\Omega$, $I_{AS} = 18\text{A}$.
- ③ $I_{SD} \leq 18\text{A}$, $di/dt \leq 360\text{A}/\mu\text{s}$, $V_{DD} \leq V_{(BR)DSS}$,
 $T_J \leq 175^\circ\text{C}$.
- ④ Pulse width $\leq 300\mu\text{s}$; duty cycle $\leq 2\%$.
- ⑤ C_{OSS} eff. is a fixed capacitance that gives the same charging time as C_{OSS} while V_{DS} is rising from 0 to 80% V_{DSS} .
- ⑥ When mounted on 1" square PCB (FR-4 or G-10 Material).
For recommended footprint and soldering techniques refer to application note #AN-994.

Data and specifications subject to change without notice.
This product has been designed and qualified for the Industrial market.
Qualification Standards can be found on IR's Web site.

International
IR Rectifier

IR WORLD HEADQUARTERS: 233 Kansas St., El Segundo, California 90245, USA Tel: (310) 252-7105
TAC Fax: (310) 252-7903

Visit us at www.irf.com for sales contact information. 09/02

www.irf.com