

PRELIMINARY
 Notice: This is not a final specification.
 Some parametric limits are subject to change.

MITSUBISHI Pch POWER MOSFET

FX20KMJ-3

HIGH-SPEED SWITCHING USE

FX20KMJ-3

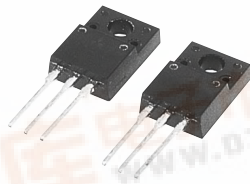

- 4V DRIVE
- V_{DSS} -150V
- r_{DS (ON)} (MAX) 0.29Ω
- I_D -20A
- Integrated Fast Recovery Diode (TYP.) 100ns
- V_{iso} 2000V

OUTLINE DRAWING

Dimensions in mm

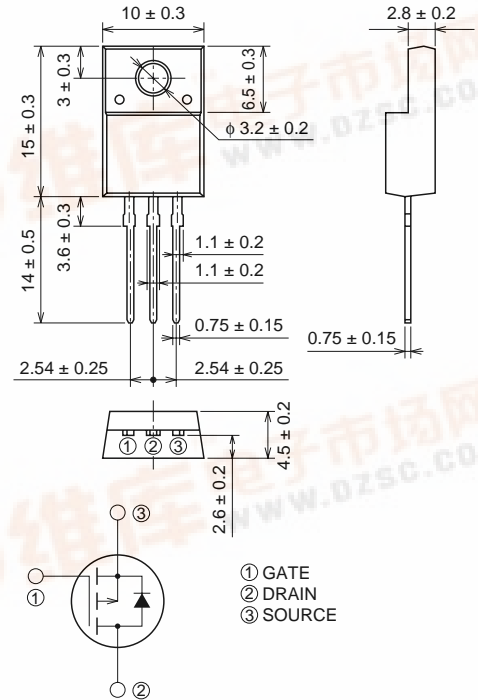

TO-220FN

APPLICATION

Motor control, Lamp control, Solenoid control
 DC-DC converter, etc.

MAXIMUM RATINGS (T_c = 25°C)

Symbol	Parameter	Conditions	Ratings	Unit
V _{DSS}	Drain-source voltage	V _{GS} = 0V	-150	V
V _{GSS}	Gate-source voltage	V _{DS} = 0V	±20	V
I _D	Drain current		-20	A
I _{DM}	Drain current (Pulsed)		-80	A
I _{DA}	Avalanche drain current (Pulsed)	L = 30μH	-20	A
I _S	Source current		-20	A
I _{SM}	Source current (Pulsed)		-80	A
P _D	Maximum power dissipation		30	W
T _{ch}	Channel temperature		-55 ~ +150	°C
T _{stg}	Storage temperature		-55 ~ +150	°C
V _{iso}	Isolation voltage	AC for 1minute, Terminal to case	2000	V
—	Weight	Typical value	2.0	g



PRELIMINARY
 Notice: This is not a final specification.
 Some parametric limits are subject to change.

ELECTRICAL CHARACTERISTICS (Tch = 25°C)

Symbol	Parameter	Test conditions	Limits			Unit
			Min.	Typ.	Max.	
V(BR)DSS	Drain-source breakdown voltage	Id = -1mA, VGS = 0V	-150	—	—	V
IGSS	Gate-source leakage current	VGS = ±20V, VDS = 0V	—	—	±0.1	μA
IDSS	Drain-source leakage current	VDS = -150V, VGS = 0V	—	—	-0.1	mA
VGS(th)	Gate-source threshold voltage	Id = -1mA, VDS = -10V	-1.0	-1.5	-2.0	V
rDS(ON)	Drain-source on-state resistance	Id = -10A, VGS = -10V	—	0.23	0.29	Ω
rDS(ON)	Drain-source on-state resistance	Id = -10A, VGS = -4V	—	0.25	0.32	Ω
VDS(ON)	Drain-source on-state voltage	Id = -10A, VGS = -10V	—	-2.3	-2.9	V
yfs	Forward transfer admittance	Id = -10A, VDS = -10V	—	17.5	—	S
Ciss	Input capacitance	VDS = -10V, VGS = 0V, f = 1MHz	—	4470	—	pF
Coss	Output capacitance		—	248	—	pF
Crss	Reverse transfer capacitance		—	115	—	pF
td(on)	Turn-on delay time	VDD = -80V, Id = -10A, VGS = -10V, RGEN = RGS = 50Ω	—	15	—	ns
tr	Rise time		—	42	—	ns
td(off)	Turn-off delay time		—	273	—	ns
tf	Fall time		—	114	—	ns
VSD	Source-drain voltage	Is = -10A, VGS = 0V	—	-1.0	-1.5	V
Rth(ch-c)	Thermal resistance	Channel to case	—	—	4.17	°C/W
trr	Reverse recovery time	Is = -20A, dis/dt = 100A/μs	—	100	—	ns

PERFORMANCE CURVES

POWER DISSIPATION DERATING CURVE

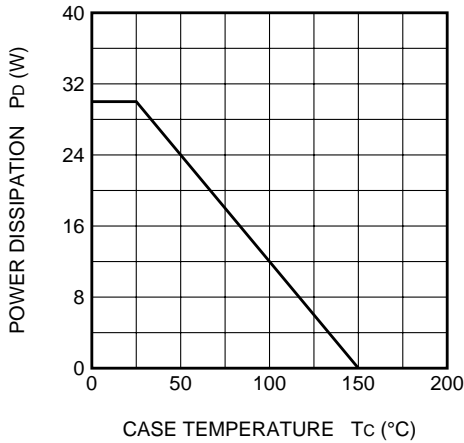

MAXIMUM SAFE OPERATING AREA

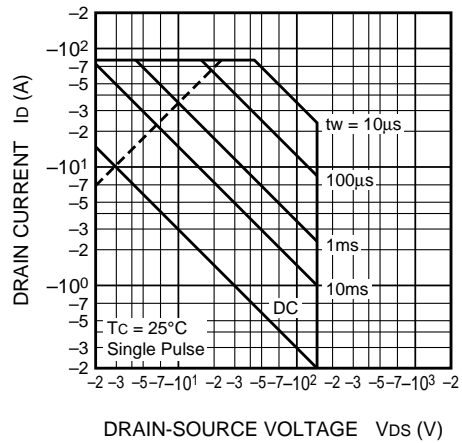

OUTPUT CHARACTERISTICS (TYPICAL)

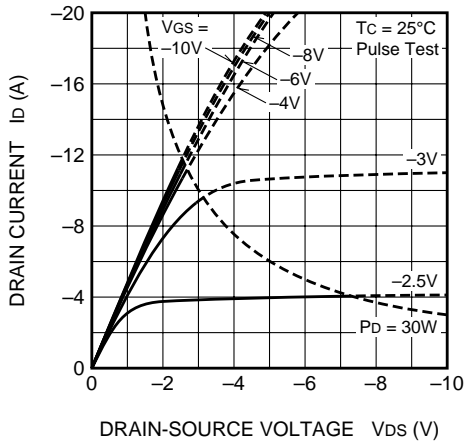

OUTPUT CHARACTERISTICS (TYPICAL)

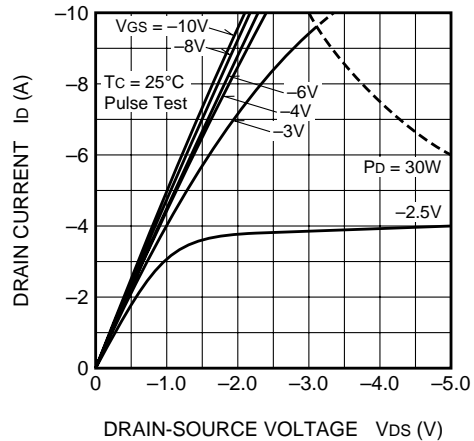

PRELIMINARY
 Notice: This is not a final specification.
 Some parametric limits are subject to change.

ON-STATE VOLTAGE VS. GATE-SOURCE VOLTAGE (TYPICAL)

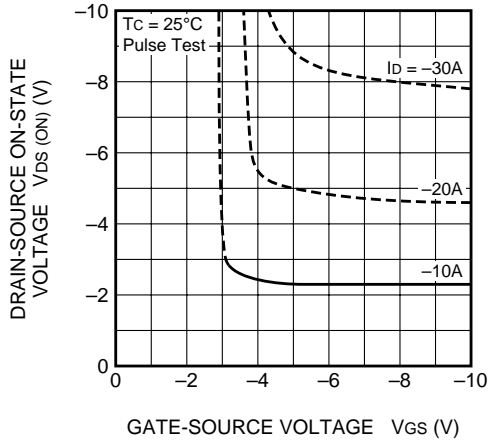

ON-STATE RESISTANCE VS. DRAIN CURRENT (TYPICAL)

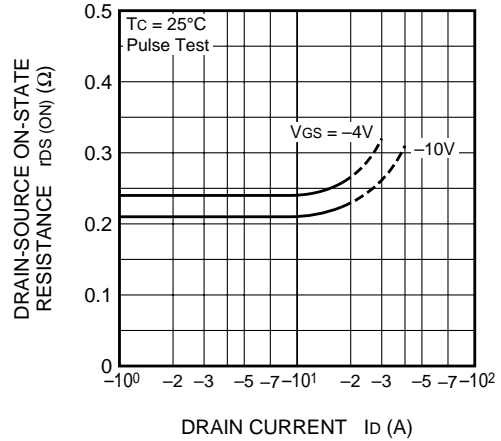

TRANSFER CHARACTERISTICS (TYPICAL)

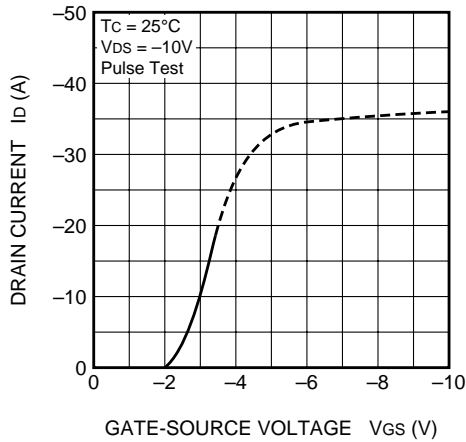

FORWARD TRANSFER ADMITTANCE VS. DRAIN CURRENT (TYPICAL)

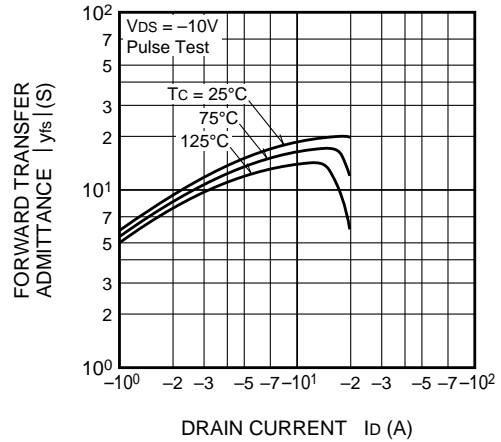

CAPACITANCE VS. DRAIN-SOURCE VOLTAGE (TYPICAL)

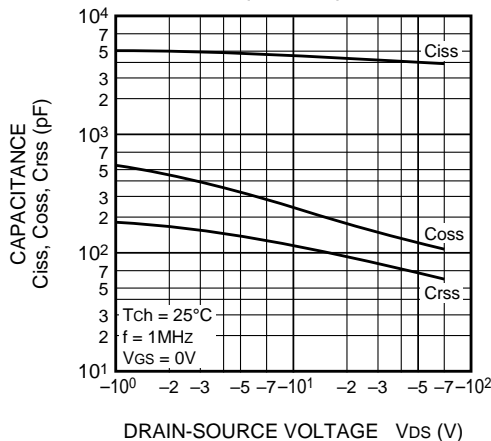

SWITCHING CHARACTERISTICS (TYPICAL)

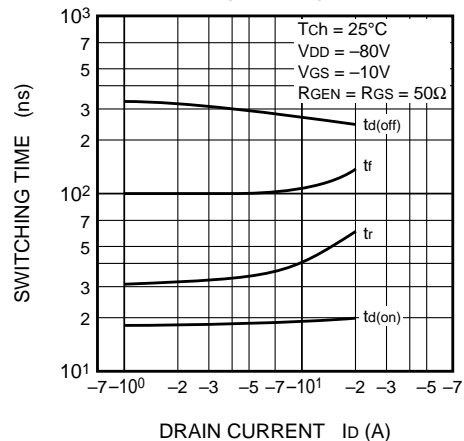

PRELIMINARY
 Notice: This is not a final specification.
 Some parametric limits are subject to change.

