

PRELIMINARY
 Notice: This is not a final specification.
 Some parametric limits are subject to change.

MITSUBISHI Pch POWER MOSFET

FX6KMJ-3

HIGH-SPEED SWITCHING USE

FX6KMJ-3

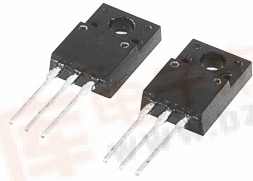

- 4V DRIVE
- V_{DSS} -150V
- $r_{DS(ON)}$ (MAX) 0.53Ω
- I_D -6A
- Integrated Fast Recovery Diode (TYP.) 100ns
- V_{iso} 2000V

OUTLINE DRAWING

Dimensions in mm

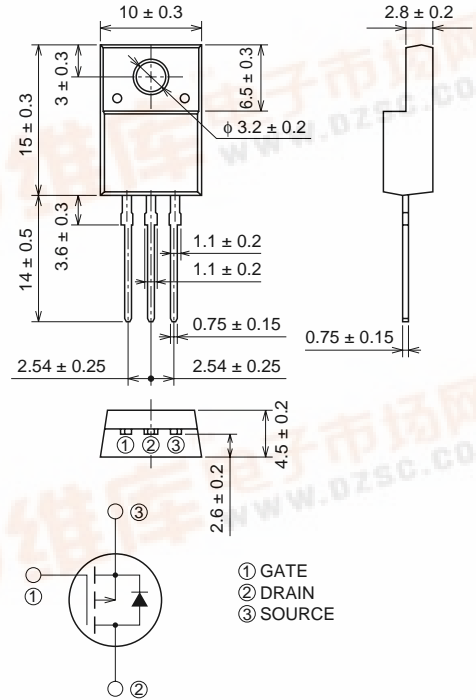

TO-220FN

APPLICATION

Motor control, Lamp control, Solenoid control
 DC-DC converter, etc.

MAXIMUM RATINGS (Tc = 25°C)

Symbol	Parameter	Conditions	Ratings	Unit
V_{DSS}	Drain-source voltage	$V_{GS} = 0V$	-150	V
V_{GSS}	Gate-source voltage	$V_{DS} = 0V$	± 20	V
I_D	Drain current		-6	A
I_{DM}	Drain current (Pulsed)		-24	A
I_{DA}	Avalanche drain current (Pulsed)	$L = 100\mu H$	-6	A
I_S	Source current		-6	A
I_{SM}	Source current (Pulsed)		-24	A
P_D	Maximum power dissipation		25	W
T_{ch}	Channel temperature		-55 ~ +150	°C
T_{stg}	Storage temperature		-55 ~ +150	°C
V_{iso}	Isolation voltage	AC for 1minute, Terminal to case	2000	V
—	Weight	Typical value	2.0	g



PRELIMINARY
 Notice: This is not a final specification.
 Some parametric limits are subject to change.

ELECTRICAL CHARACTERISTICS (Tch = 25°C)

Symbol	Parameter	Test conditions	Limits			Unit
			Min.	Typ.	Max.	
V(BR)DSS	Drain-source breakdown voltage	Id = -1mA, Vgs = 0V	-150	—	—	V
IGSS	Gate-source leakage current	VGS = ±20V, VDS = 0V	—	—	±0.1	μA
IDSS	Drain-source leakage current	VDS = -150V, VGS = 0V	—	—	-0.1	mA
VGS(th)	Gate-source threshold voltage	Id = -1mA, VDS = -10V	-1.0	-1.5	-2.0	V
rDS(ON)	Drain-source on-state resistance	Id = -3A, VGS = -10V	—	0.41	0.53	Ω
rDS(ON)	Drain-source on-state resistance	Id = -3A, VGS = -4V	—	0.45	0.59	Ω
VDS(ON)	Drain-source on-state voltage	Id = -3A, VGS = -10V	—	-1.23	-1.59	V
yfs	Forward transfer admittance	Id = -3A, VDS = -10V	—	7.9	—	S
Ciss	Input capacitance	VDS = -10V, VGS = 0V, f = 1MHz	—	2420	—	pF
Coss	Output capacitance		—	152	—	pF
Crss	Reverse transfer capacitance		—	69	—	pF
td(on)	Turn-on delay time	VDD = -80V, Id = -3A, VGS = -10V, RGEN = RGS = 50Ω	—	14	—	ns
tr	Rise time		—	18	—	ns
td(off)	Turn-off delay time		—	156	—	ns
tf	Fall time		—	58	—	ns
VSD	Source-drain voltage	Is = -3A, VGS = 0V	—	-1.0	-1.5	V
Rth(ch-c)	Thermal resistance	Channel to case	—	—	5.00	°C/W
trr	Reverse recovery time	Is = -6A, dis/dt = 100A/μs	—	100	—	ns

PERFORMANCE CURVES

POWER DISSIPATION DERATING CURVE

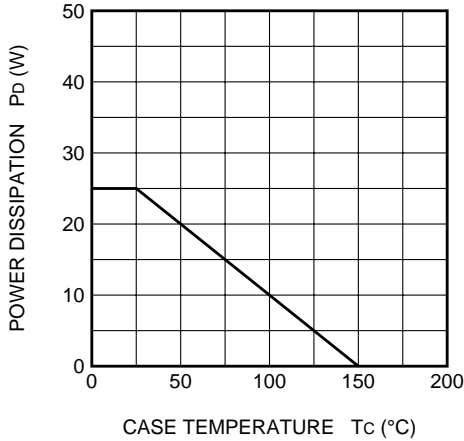

MAXIMUM SAFE OPERATING AREA

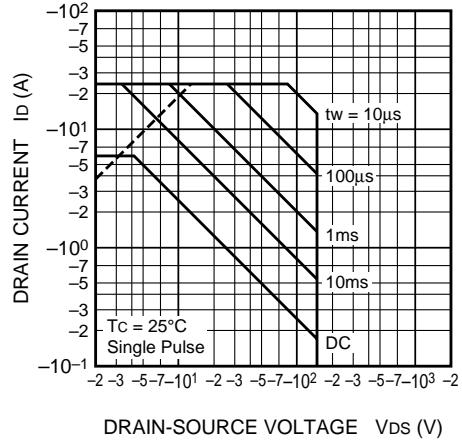

OUTPUT CHARACTERISTICS (TYPICAL)

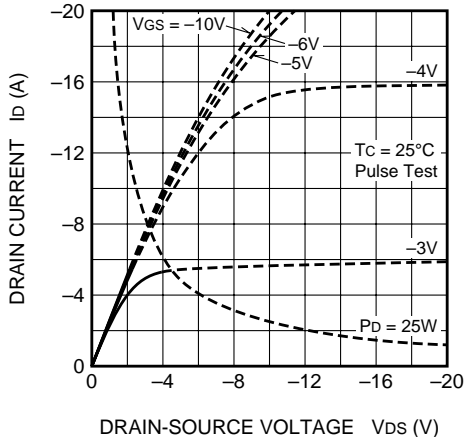

OUTPUT CHARACTERISTICS (TYPICAL)

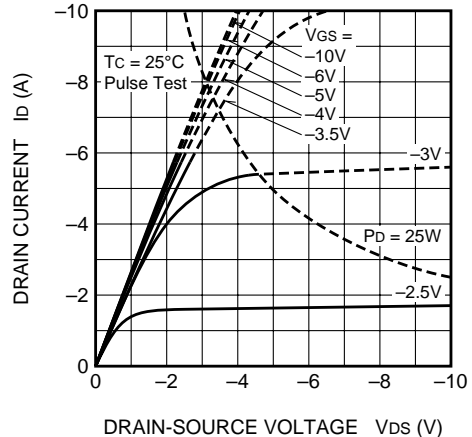

PRELIMINARY
 Notice: This is not a final specification.
 Some parametric limits are subject to change.

ON-STATE VOLTAGE VS. GATE-SOURCE VOLTAGE (TYPICAL)

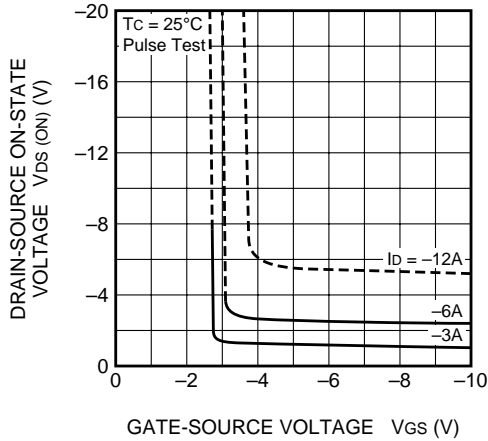

ON-STATE RESISTANCE VS. DRAIN CURRENT (TYPICAL)

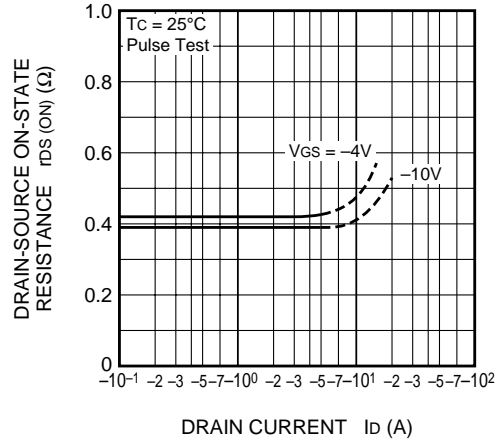

TRANSFER CHARACTERISTICS (TYPICAL)

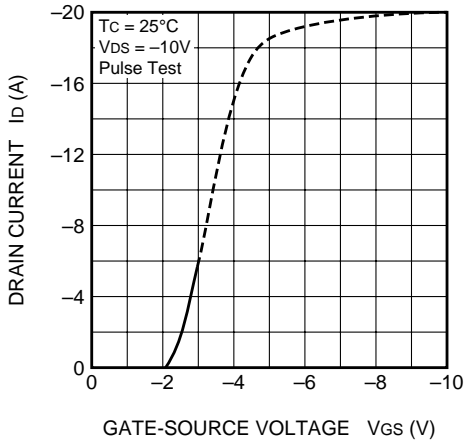

FORWARD TRANSFER ADMITTANCE VS. DRAIN CURRENT (TYPICAL)

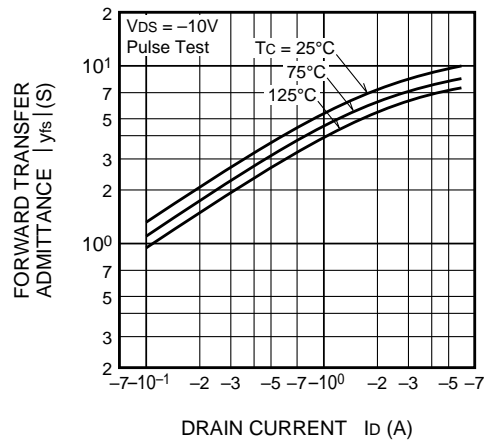

CAPACITANCE VS. DRAIN-SOURCE VOLTAGE (TYPICAL)

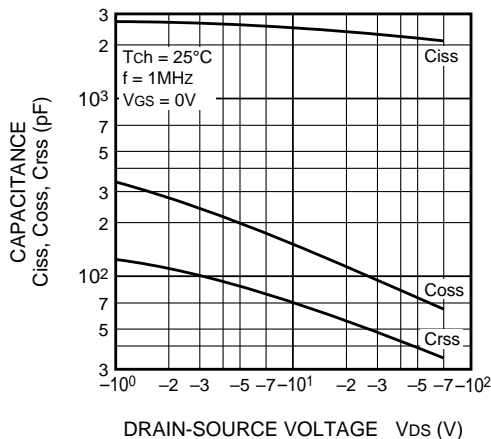

SWITCHING CHARACTERISTICS (TYPICAL)

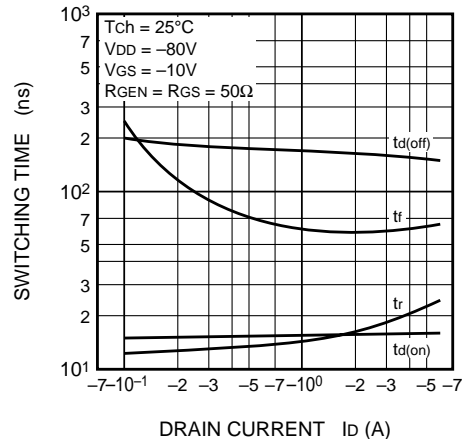

PRELIMINARY
 Notice: This is not a final specification.
 Some parametric limits are subject to change.

GATE-SOURCE VOLTAGE VS. GATE CHARGE (TYPICAL)

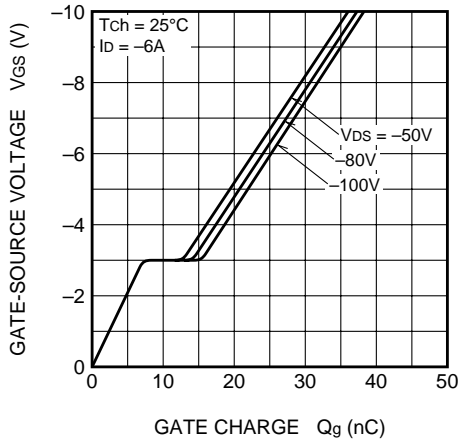

SOURCE-DRAIN DIODE FORWARD CHARACTERISTICS (TYPICAL)

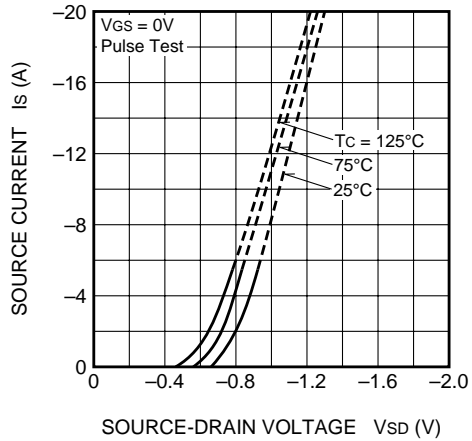

ON-STATE RESISTANCE VS. CHANNEL TEMPERATURE (TYPICAL)

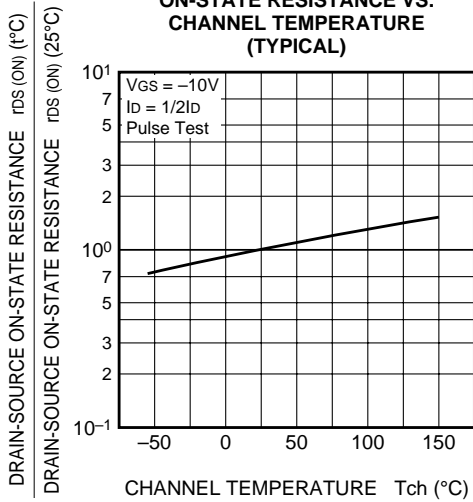

THRESHOLD VOLTAGE VS. CHANNEL TEMPERATURE (TYPICAL)

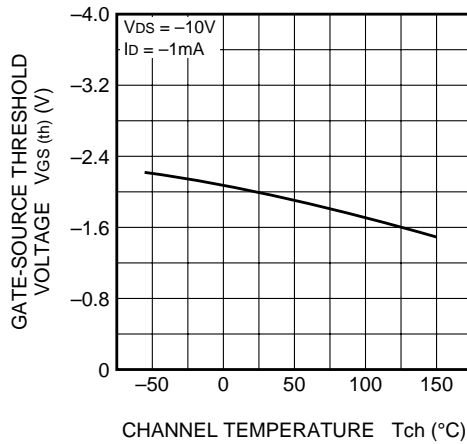

BREAKDOWN VOLTAGE VS. CHANNEL TEMPERATURE (TYPICAL)

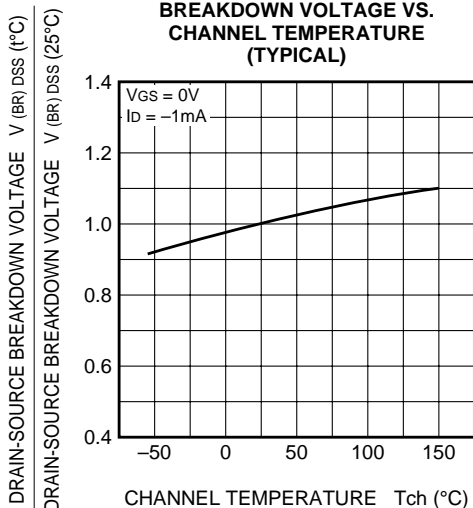

TRANSIENT THERMAL IMPEDANCE CHARACTERISTICS

