

International IOR Rectifier

HEXFET® POWER MOSFET

IRFY9240CM

P-CHANNEL

-200 Volt, 0.51Ω HEXFET

International Rectifier's HEXFET technology is the key to its advanced line of power MOSFET transistors. The efficient geometry design achieves very low on-state resistance combined with high transconductance.

HEXFET power MOSFETs also feature all of the well-established advantages of MOSFETs, such as voltage control, very fast switching, ease of paralleling and electrical parameter temperature stability. They are well-suited for applications such as switching power supplies, motor controls, inverters, choppers, audio amplifiers, high energy pulse circuits, and virtually any application where high reliability is required.

The HEXFET power MOSFET's totally isolated package eliminates the need for additional isolating material between the device and the heatsink. This improves thermal efficiency and reduces drain capacitance.

Product Summary

Part Number	BV _{DSS}	R _{DS(on)}	I _D
IRFY9240CM	-200V	0.51Ω	-9.4A

Features

- Hermetically Sealed
- Electrically Isolated
- Simple Drive Requirements
- Ease of Paralleling

Absolute Maximum Ratings

	Parameter	IRFY9240CM	Units
I _D @ V _{GS} = -10V, T _C = 25°C	Continuous Drain Current	-9.4	A
I _D @ V _{GS} = -10V, T _C = 100°C	Continuous Drain Current	-6.0	
I _{DM}	Pulsed Drain Current ①	-36	
P _D @ T _C = 25°C	Max. Power Dissipation	100	W
	Linear Derating Factor	0.8	W/K②
V _{GS}	Gate-to-Source Voltage	±20	V
E _{AS}	Single Pulse Avalanche Energy ②	700	mJ
I _{AR}	Avalanche Current ①	-9.4	A
E _{AR}	Repetitive Avalanche Energy ①	10	mJ
dv/dt	Peak Diode Recovery dv/dt ③	-5.5	V/ns
T _J	Operating Junction	-55 to 150	°C
T _{STG}	Storage Temperature Range		
	Lead Temperature	300 (0.063 in (1.6mm) from case for 10 sec)	
	Weight	4.3(typical)	g

* I_D current limited by pin diameter

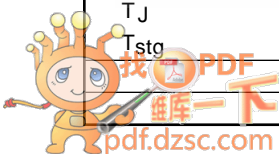

IRFY9240CM Device

Electrical Characteristics @ T_j = 25°C (Unless Otherwise Specified)

	Parameter	Min	Typ	Max	Units	Test Conditions
B _V D _{SS}	Drain-to-Source Breakdown Voltage	-200	—	—	V	V _{GS} = 0V, I _D = -1.0mA
ΔB _V D _{SS} /ΔT _J	Temperature Coefficient of Breakdown Voltage	—	-0.20	—	V/°C	Reference to 25°C, I _D = -1.0mA
R _{DS(on)}	Static Drain-to-Source On-State Resistance	—	—	0.51	Ω	V _{GS} = -10V, I _D = -6.0A ④
		—	—	0.52		V _{GS} = -10V, I _D = -9.4A ④
V _{GS(th)}	Gate Threshold Voltage	-2.0	—	-4.0	V	V _{DS} = V _{GS} , I _D = -250μA
g _{fs}	Forward Transconductance	4.0	—	—	S (r _s)	V _{DS} ≥ -15V, I _{DS} = -6.0A ④
I _{DSS}	Zero Gate Voltage Drain Current	—	—	-25	μA	V _{DS} = 0.8 x max. rating, V _{GS} = 0V
		—	—	-250		V _{DS} = 0.8 x max. rating V _{GS} = 0V, T _J = 125°C
I _{GSS}	Gate-to-Source Leakage Forward	—	—	-100	nA	V _{GS} = -20V
I _{GSS}	Gate-to-Source Leakage Reverse	—	—	100	nA	V _{GS} = 20V
Q _g	Total Gate Charge	28	—	60	nC	V _{GS} = -10V, I _D = -9.4A
Q _{gs}	Gate-to-Source Charge	3.0	—	15		V _{DS} = Max. Rating x 0.5
Q _{gd}	Gate-to-Drain ('Miller') Charge	4.5	—	38		see figures 6 and 13
t _{d(on)}	Turn-On Delay Time	—	—	35	ns	V _{DD} = -100V, I _D = -9.4A R _G = 9.1Ω, V _{GS} = -10V
t _r	Rise Time	—	—	85		
t _{d(off)}	Turn-Off Delay Time	—	—	85		
t _f	Fall Time	—	—	65		
L _D	Internal Drain Inductance	—	8.7	—	nH	<p>Measured from the drain lead, 6mm (0.25 in.) from package to center of die.</p> <p>Measured from the source lead, 6mm (0.25 in.) from package to source bonding pad.</p> 
L _S	Internal Source Inductance	—	8.7	—		
C _{iSS}	Input Capacitance	—	1200	—	pF	V _{GS} = 0V, V _{DS} = -25V f = 1.0MHz. see figure 5
C _{oSS}	Output Capacitance	—	570	—		
C _{rSS}	Reverse Transfer Capacitance	—	81	—		

Source-Drain Diode Ratings and Characteristics

	Parameter	Min	Typ	Max	Units	Test Conditions
I _S	Continuous Source Current (Body Diode)	—	—	-9.4	A	Modified MOSFET symbol showing the integral reverse p-n junction rectifier. 
I _{SM}	Pulse Source Current (Body Diode) ①	—	—	-36		
V _{SD}	Diode Forward Voltage	—	—	-4.6	V	T _j = 25°C, I _S = -9.4A, V _{GS} = 0V ④
t _{rr}	Reverse Recovery Time	—	—	440	ns	T _j = 25°C, I _F = -9.4A, di/dt ≤ -100 A/μs
Q _{RR}	Reverse Recovery Charge	—	—	7.2	μC	V _{DD} ≤ -50 V ④
t _{on}	Forward Turn-On Time	Intrinsic turn-on time is negligible. Turn-on speed is substantially controlled by L _S + L _D .				

Thermal Resistance

	Parameter	Min	Typ	Max	Units	Test Conditions
R _{thJC}	Junction-to-Case	—	—	1.25	K/W ⑤	Typical socket mount Mounting surface flat, smooth
R _{thJA}	Junction-to-Ambient	—	—	80		
R _{thCS}	Case-to-Sink	—	0.21	—		

IRFY9240CM Device

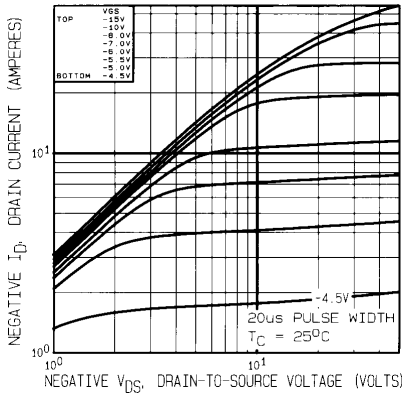

Fig. 1 — Typical Output Characteristics
 $T_C = 25^\circ\text{C}$

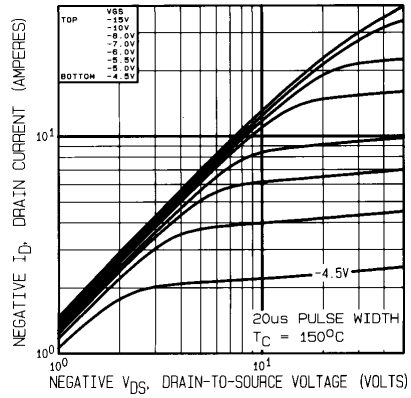

Fig. 2 — Typical Output Characteristics
 $T_C = 150^\circ\text{C}$

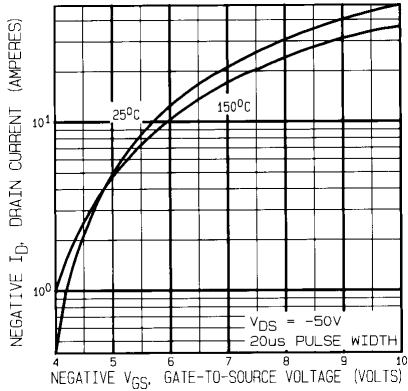

Fig. 3 — Typical Transfer Characteristics

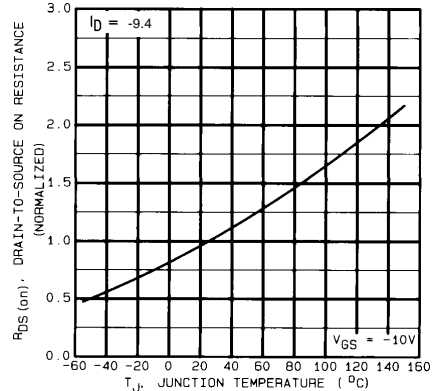

Fig. 4 — Normalized On-Resistance vs. Temperature

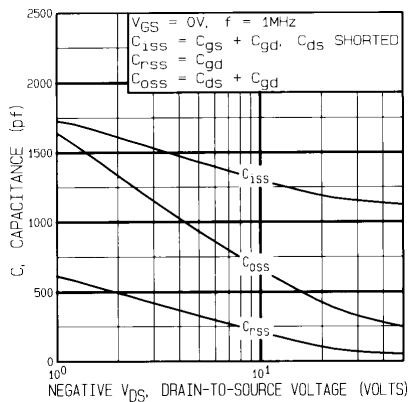

Fig. 5 — Typical Capacitance vs. Drain-to-Source Voltage

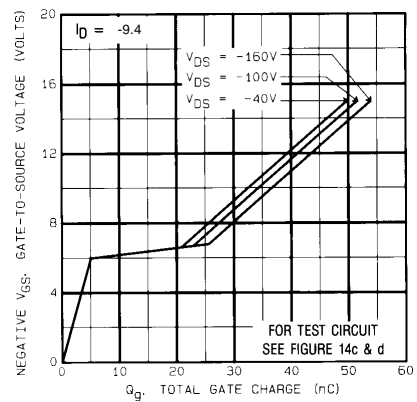

Fig. 6 — Typical Gate Charge vs. Gate-to-Source Voltage

IRFY9240CM Device

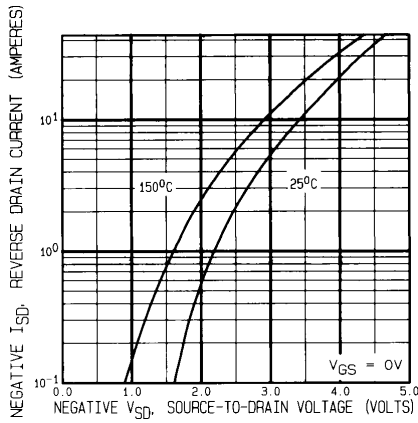

Fig. 7 — Typical Source-to-Drain Diode Forward Voltage

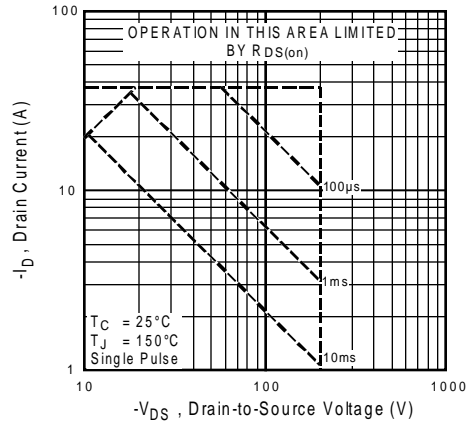

Fig. 8 — Maximum Safe Operating Area

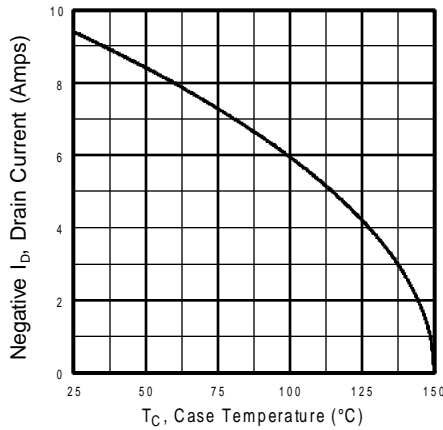

Fig. 9 — Maximum Drain Current vs. Case Temperature

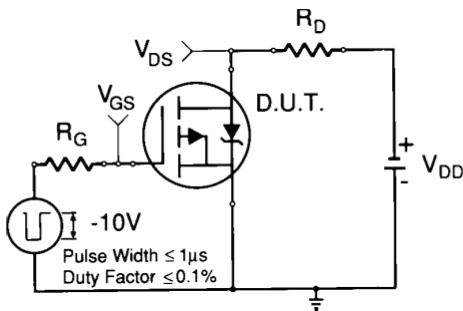

Fig. 10a — Switching Time Test Circuit

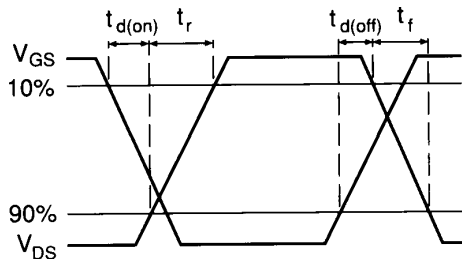

Fig. 10b — Switching Time Waveforms

IRFY9240CM Device

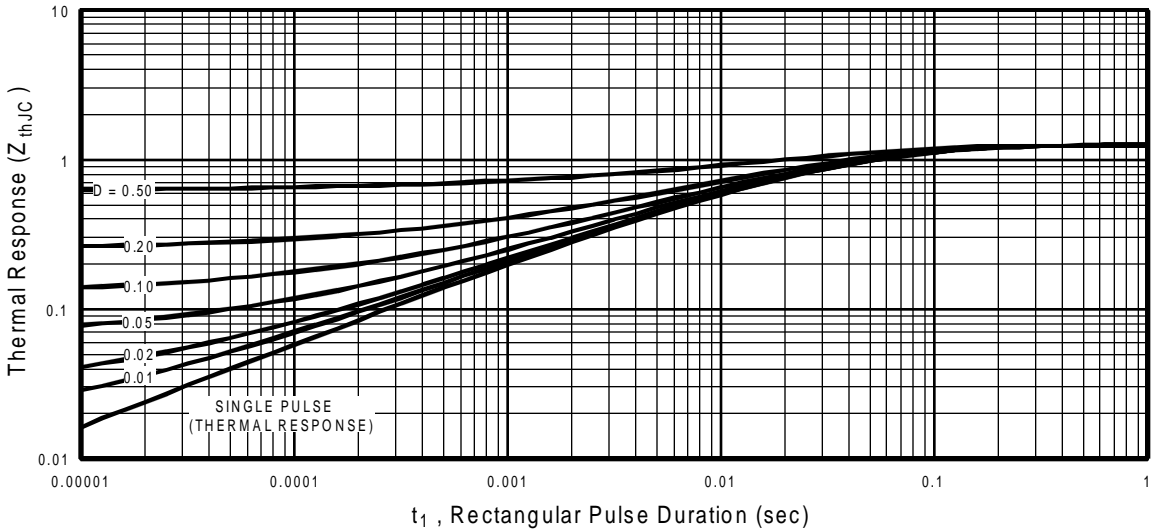

Fig. 11 — Maximum Effective Transient Thermal Impedance, Junction-to-Case Vs. Pulse Duration

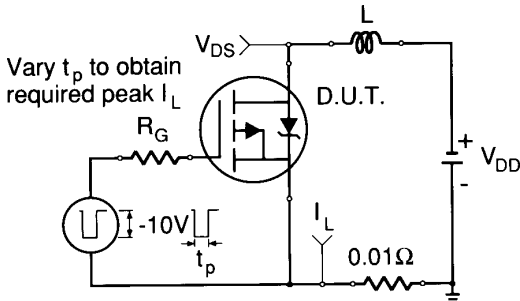

Fig. 12a — Unclamped Inductive Test Circuit

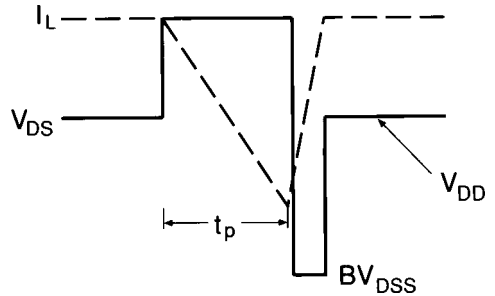

Fig. 12b — Unclamped Inductive Waveforms

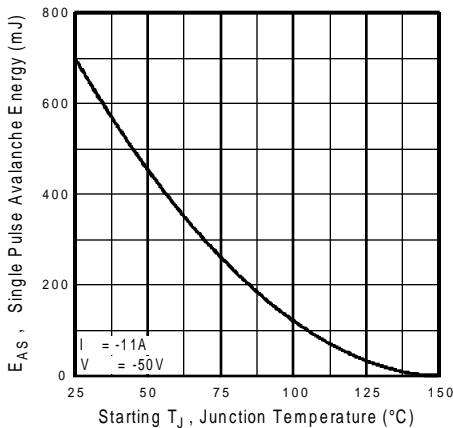

Fig. 12c — Max. Avalanche Energy vs. Current

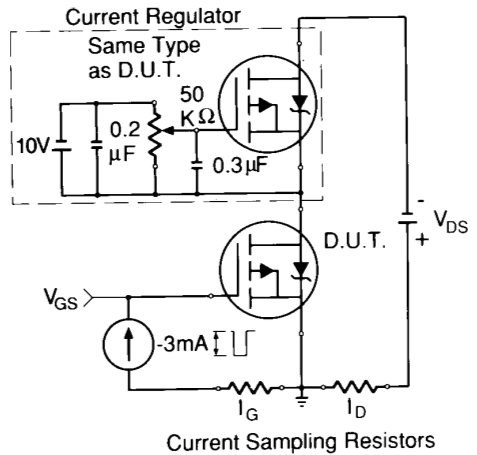

Fig. 13a — Gate Charge Test Circuit

IRFY9240CM Device

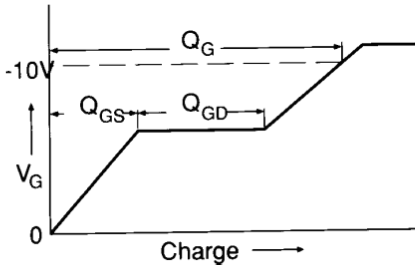

Fig. 13b — Basic Gate Charge Waveform

Notes:

- ① Repetitive Rating; Pulse width limited by maximum junction temperature (see figure 11).
- ② @ $V_{DD} = -50V$, Starting $T_J = 25^\circ C$,
 $EAS = [0.5 \cdot L \cdot (I_L^2) \cdot [BVDSS/(BVDSS-V_{DD})]]$
 Peak $I_L = -9.4A$, $V_{GS} = -10V$, $25 \leq R_G \leq 200\Omega$
- ③ $I_{SD} \leq -9.4A$, $di/dt \leq -150A/\mu s$, $V_{DD} \leq BVDSS$, $T_J \leq 150^\circ C$
- ④ Pulse width $\leq 300 \mu s$; Duty Cycle $\leq 2\%$
- ⑤ $K/W = ^\circ C/W$ $W/K = W/^\circ C$

Case Outline and Dimensions

Pin 1 - Drain
Pin 2 - Source
Pin 3 - Gate

TO-257AA

NON-STANDARD PIN CONFIGURATION

Pin 1 - Gate
Pin 2 - Drain
Pin 3 - Source

Order Part Type IRFY9240C

NOTES:

1. Dimensioning and tolerancing per ANSI Y14.5M-1982
2. Controlling dimension: Inch
3. Dimensions are shown in millimeters (Inches)
4. Outline conforms to JEDEC outline TO-257AA

CAUTION

BERYLLIUM WARNING PER MIL-PRF-19500

Packages containing beryllia shall not be ground, sandblasted, machined or have other operations performed on them which will produce beryllia or beryllium dust. Furthermore, beryllium oxide packages shall not be placed in acids that will produce fumes containing beryllium.



WORLD HEADQUARTERS: 233 Kansas St., El Segundo, California 90245, Tel: (310) 322 3331
EUROPEAN HEADQUARTERS: Hurst Green, Oxted, Surrey RH8 9BB, UK Tel: ++ 44(0) 1883 732020

IR CANADA: 7321 Victoria Park Ave., Suite 201, Markham, Ontario L3R 2Z8, Tel: (905) 475 1897

IR GERMANY: Saalburgstrasse 157, 61350 Bad Homburg Tel: ++ 49 6172 96590

IR ITALY: Via Liguria 49, 10071 Borgaro, Torino Tel: ++ 39 11 451 0111

IR FAR EAST: K&H Bldg., 2F, 3-30-4 Nishi-Ikeburo 3-Chome, Toshima-Ki, Tokyo Japan 171 Tel: 81 3 3983 0086

IR SOUTHEAST ASIA: 315 Outram Road, #10-02 Tan Boon Liat Building, Singapore 0316 Tel: 65 221 8371