



Preliminary data

Low $V_{CE(sat)}$ IGBT High speed IGBT

IXGA/IXGP/IXGH10N60
IXGA/IXGP/IXGH10N60A

V_{CES}	I_{C25}	$V_{CE(sat)}$
600 V	20 A	2.5 V
600 V	20 A	3.0 V

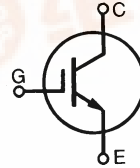

Symbol	Test Conditions	Maximum Ratings	
V_{CES}	$T_J = 25^\circ\text{C}$ to 150°C	600	V
V_{CGR}	$T_J = 25^\circ\text{C}$ to 150°C ; $R_{GE} = 1\text{ M}\Omega$	600	V
V_{GES}	Continuous	± 20	V
V_{GEM}	Transient	± 30	V
I_{C25}	$T_C = 25^\circ\text{C}$	20	A
I_{C90}	$T_C = 90^\circ\text{C}$	10	A
I_{CM}	$T_C = 25^\circ\text{C}$, 1 ms	40	A
SSOA (RBSOA)	$V_{GE} = 15\text{ V}$, $T_{VJ} = 125^\circ\text{C}$, $R_G = 150\ \Omega$ Clamped inductive load, $L = 300\ \mu\text{H}$	$I_{CM} = 20$ @ $0.8 V_{CES}$	A
P_C	$T_C = 25^\circ\text{C}$	100	W
T_J		-55 ... +150	$^\circ\text{C}$
T_{JM}		150	$^\circ\text{C}$
T_{stg}		-55 ... +150	$^\circ\text{C}$
Maximum Lead and Tab temperature for soldering 1.6 mm (0.062 in.) from case for 10 s		300	$^\circ\text{C}$
M_d	Mounting torque, TO-247 AD	1.13/10	Nm/lb.in.
Weight	TO-263 AA	2	g
	TO-247 AD	6	g

TO-220AB(IXGP)

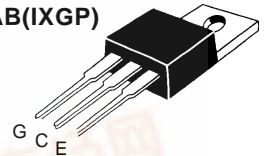

TO-263 AA (IXGA)

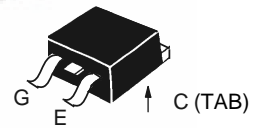

TO-247 AD (IXGH)

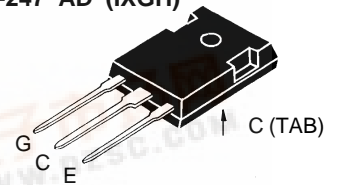

G = Gate, C = Collector,
E = Emitter, TAB = Collector

Features

- International standard packages
JEDEC TO-263 AA surface mountable and JEDEC TO-247 AD
- 2nd generation HDMOS™ process
Low $V_{CE(sat)}$
- for low on-state conduction losses
- High current handling capability
- MOS Gate turn-on
- drive simplicity

Applications

- AC motor speed control
- DC servo and robot drives
- DC choppers
- Uninterruptible power supplies (UPS)
- Switch-mode and resonant-mode power supplies

Advantages

- Space savings, TO-263 AA
- Facilitates automated assembly
- Reduces assembly time and cost
- Easy to mount with 1 screw, TO-247 (isolated mounting screw hole)
- High power density

Symbol	Test Conditions	Characteristic Values ($T_J = 25^\circ\text{C}$, unless otherwise specified)		
		min.	typ.	max.
BV_{CES}	$I_C = 250\ \mu\text{A}$, $V_{GE} = 0\text{ V}$	600		V
$V_{GE(th)}$	$I_C = 250\ \mu\text{A}$, $V_{CE} = V_{GE}$	2.5		V
I_{CES}	$V_{CE} = 0.8 \cdot V_{CES}$ $V_{GE} = 0\text{ V}$	$T_J = 25^\circ\text{C}$		200 μA
		$T_J = 125^\circ\text{C}$		1 mA
I_{GES}	$V_{CE} = 0\text{ V}$, $V_{GE} = \pm 20\text{ V}$			$\pm 100\text{ nA}$
$I_{C(sat)}$	$I_C = I_{C90}$, $V_{GE} = 15\text{ V}$	10N60		2.5 V
		10N60A		3.0 V



Symbol	Test Conditions	Characteristic Values			
		$(T_J = 25^\circ\text{C}, \text{ unless otherwise specified})$			
		min.	typ.	max.	
g_{fs}	$I_C = I_{C90}, V_{CE} = 10\text{ V},$ Pulse test, $t \leq 300\ \mu\text{s}$, duty cycle $\leq 2\%$	4	8	S	
C_{ies}	$V_{CE} = 25\text{ V}, V_{GE} = 0\text{ V}, f = 1\text{ MHz}$		750	pF	
C_{oes}			100	pF	
C_{res}			30	pF	
Q_g	$I_C = I_{C90}, V_{GE} = 15\text{ V}, V_{CE} = 0.5 V_{CES}$		50	nC	
Q_{ge}			15	nC	
Q_{gc}			25	nC	
$t_{d(on)}$	Inductive load, $T_J = 25^\circ\text{C}$ $I_C = I_{C90}, V_{GE} = 15\text{ V}, L = 100\ \mu\text{H}$ $V_{CE} = 0.8 V_{CES},$ $R_G = R_{off} = 150\ \Omega$ Remarks: Switching times may increase for V_{CE} (Clamp) $> 0.8 \cdot V_{CES},$ higher T_J or increased R_G		100	ns	
t_{ri}			200	ns	
E_{on}			0.4	mJ	
$t_{d(off)}$			600	ns	
t_{fi}		10N60A	300	ns	
E_{off}		10N60A	0.6	mJ	
$t_{d(on)}$	Inductive load, $T_J = 125^\circ\text{C}$ $I_C = I_{C90}, V_{GE} = 15\text{ V},$ $L = 100\ \mu\text{H}$ $V_{CE} = 0.8 V_{CES},$ $R_G = R_{off} = 150\ \Omega$ Remarks: Switching times may increase for V_{CE} (Clamp) $> 0.8 \cdot V_{CES},$ higher T_J or increased R_G		100	ns	
t_{ri}			200	ns	
E_{on}			1	mJ	
$t_{d(off)}$			900	1500	ns
t_{fi}		10N60	570	2000	ns
E_{off}		10N60A	360	600	ns
R_{thJC}				1.25 K/W	
R_{thCK}		0.25		K/W	

IXGA/P/IXGH 10N60 / 10N60A characteristic curves are located in the IXGH 10N60U1 and IXGH 10N60AU1 data sheet.

TO-247 AD Outline

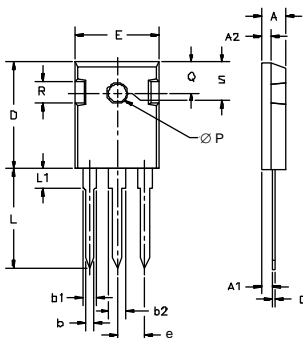

Dim.	Millimeter		Inches	
	Min.	Max.	Min.	Max.
A	4.7	5.3	.185	.209
A ₁	2.2	2.54	.087	.102
A ₂	2.2	2.6	.059	.098
b	1.0	1.4	.040	.055
b ₁	1.65	2.13	.065	.084
b ₂	2.87	3.12	.113	.123
C	.4	.8	.016	.031
D	20.80	21.46	.819	.845
E	15.75	16.26	.610	.640
e	5.20	5.72	0.205	0.225
L	19.81	20.32	.780	.800
L ₁		4.50		.177
ØP	3.55	3.65	.140	.144
Q	5.89	6.40	0.232	0.252
R	4.32	5.49	.170	.216
S	6.15	BSC	242	BSC

TO-220 AB Outline

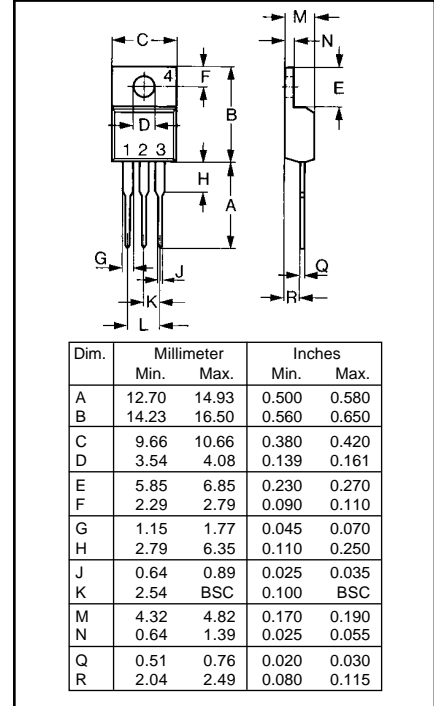

TO-263 AA Outline

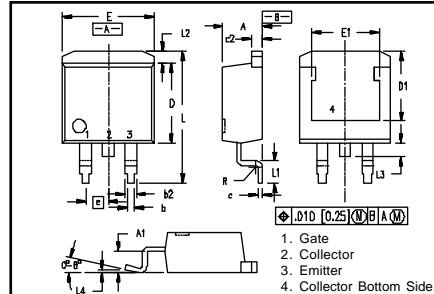

Min. Recommended Footprint

