

## V25+™

### 16/8-BIT SINGLE-CHIP MICROCONTROLLER

The  $\mu$ PD70325 (V25+) is a single-chip microcontroller on which 16-bit CPU, RAM, serial interface, timer, DMA controller, interrupt controller, etc. are all integrated. The  $\mu$ PD70325 is software compatible with the 16/8-bit single-chip microcontroller  $\mu$ PD70320 (V25™). The V25+ greatly improves the DMA responsiveness and transfer rate compared to the V25.

#### FEATURES

- Software compatible with V25
- Software compatible with  $\mu$ PD70108/70116 (in native mode) (some instructions added)
- Internal 16-bit architecture and external 8-bit data bus
- 3-stage pipeline method
- Minimum instruction cycle : 250 ns/8 MHz (external 16 MHz)  
: 200 ns/10 MHz (external 20 MHz)
- Memory space 1 Mbyte
- On-chip RAM : 256 words  $\times$  8 bits
- Register bank (memory mapped method) : 8 banks
- Input port (port T) with comparator : 8 bits
- I/O lines (input port : 4 bits, input/output ports : 20 bits)
- Serial interface : 2 channels
  - Internal dedicated baud rate generator
  - Asynchronous mode and I/O interface mode
- Interrupt controller
  - Programmable priority (8 levels)
  - 3 types of interrupt response method  
Vectored interrupt function, register bank switching function, macro service function
- DRAM and pseudo SRAM refreshing function
- DMA controller : 2 channels
  - 4 types of DMA transfer mode
  - Transfer rate Maximum 4 Mbytes/second (when stop control is not executed by DMARQ pin in demand release mode)  
Maximum 2 Mbytes/second (when stop control is executed by DMARQ pin in demand release mode, or burst mode)
  - Address pointer (linear) : 20 bits
  - Terminal counter : 16 bits
- 16-bit timer : 2 channels
- Time base counter (20 bits) : 1 channel
- On-chip clock generator
- Programmable wait function
- Standby function (STOP, HALT)

The information in this document is subject to change without notice.

★ ORDERING INFORMATION

Part Number	Package	External Clock (MHz)
$\mu$ PD70325GJ-8-5BG	94-pin plastic QFP (20 × 20 mm)	16
$\mu$ PD70325GJ-10-5BG	94-pin plastic QFP (20 × 20 mm)	20
$\mu$ PD70325L-8	84-pin plastic QFJ (1150 × 1150 mil)	16
$\mu$ PD70325L-10	84-pin plastic QFJ (1150 × 1150 mil)	20

★ **Comparison between V25 and V25+**

		V25	V35™	V25+	V35+™
		μPD70320	μPD70330	μPD70325	μPD70335
DMA function	Transfer processing method	Depends on microprogram		Depends on dedicated hardware	
	Maximum transfer rate (8-MHz operation)	0.6 Mbytes/second	0.8 Mbytes/second	4 Mbytes/second	5.3 Mbytes/second
	Sampling timing of DMA request	Between instruction execution cycles		Between bus cycles	
	DMA service channel	In on-chip RAM area		In special function register	
	Specification method of transfer address	Segment method		Linear method	
	Execution format in single-step mode	1 DMA transfer/1 instruction execution		1 DMA transfer/1 bus cycle	
	Interrupt request during DMA transfer (demand release mode)	Accepts only NMI		Not accepted	
	Number of necessary waits when stop is controlled by $\overline{\text{DMARQ}}$ (demand release mode)	Not necessary		2 waits	
	Transfer processing units	Byte/word	Byte/word	Byte	Byte/word
	TC (terminal counter) setting value	Number of times of DMA transfer		(Number of times of DMA transfer) – 1	
	Generation timing of terminal counter	TC = 0		TC = FFFFH	
	TC output low-level width	Fixed		Expanded by wait insertion	
Serial interface	Transmit clock output in asynchronous mode (channel 0)	Not available		Available ( $\overline{\text{SCK0}}$ pin)	
	Serial error register	Yes		Serial status register	
	Receive buffer full flag	No		In serial status register	
	Transmit buffer empty flag	No		In serial status register	
	All sent flag	No		In serial status register	
Interrupt function	Interrupt source register	No		Yes	
External data bus		8 bits	16 bits	8 bits	16 bits
Maximum operating frequency		8 MHz		10 MHz	

# PIN CONFIGURATION (Top View)

- ★ 94-Pin Plastic QFP
- μPD70325GJ-8-5BG
- μPD70325GJ-10-5BG

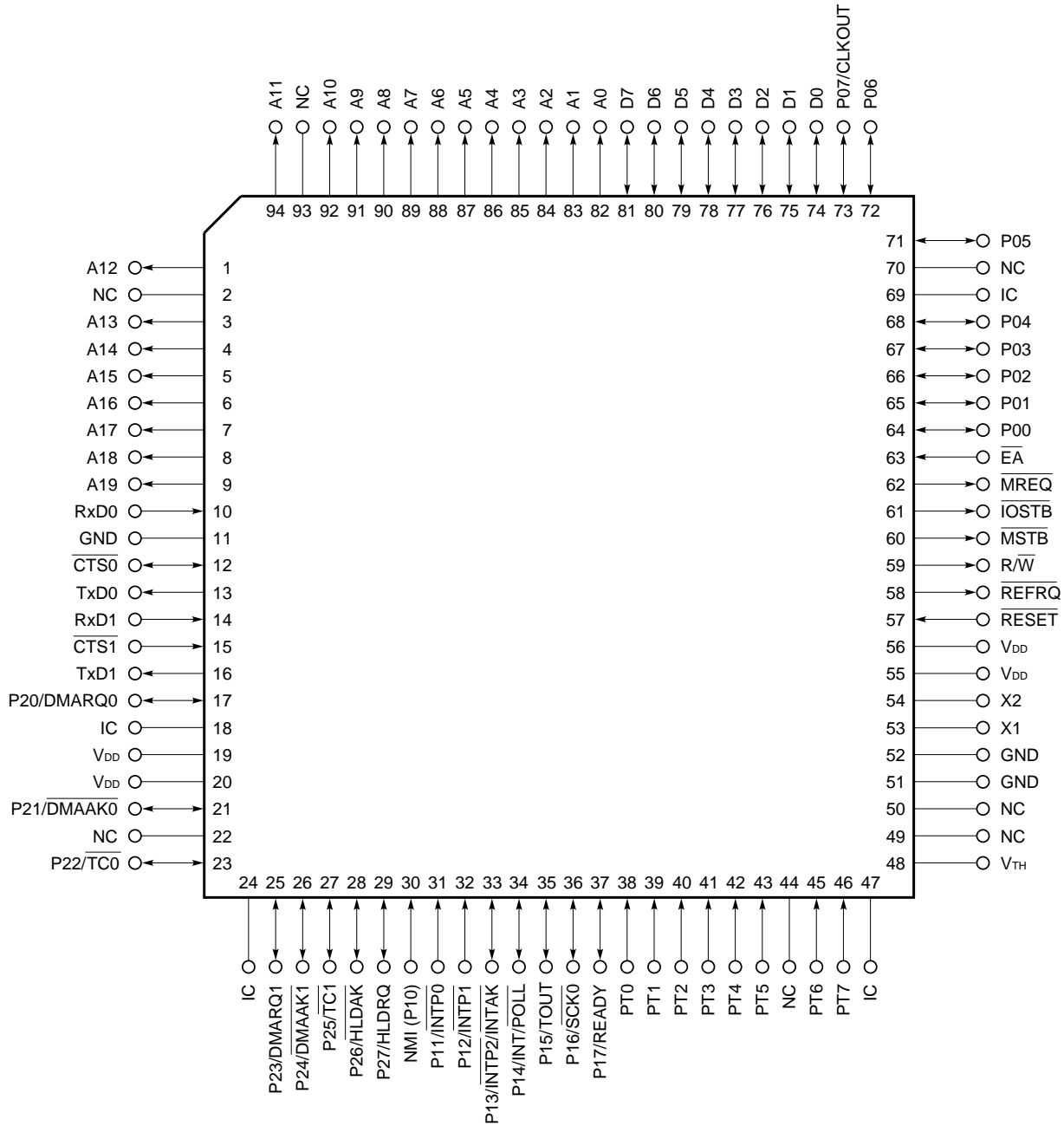

- Remarks**
1. NC: Non-Connection
  2. IC : Internally Connected

- Cautions**
1. Fix IC pin individually to high level via a pull-up resistor externally.
  2. Fix EA pin to low level.

**84-Pin Plastic QFJ**

**μPD70325L-8**

**μPD70325L-10**

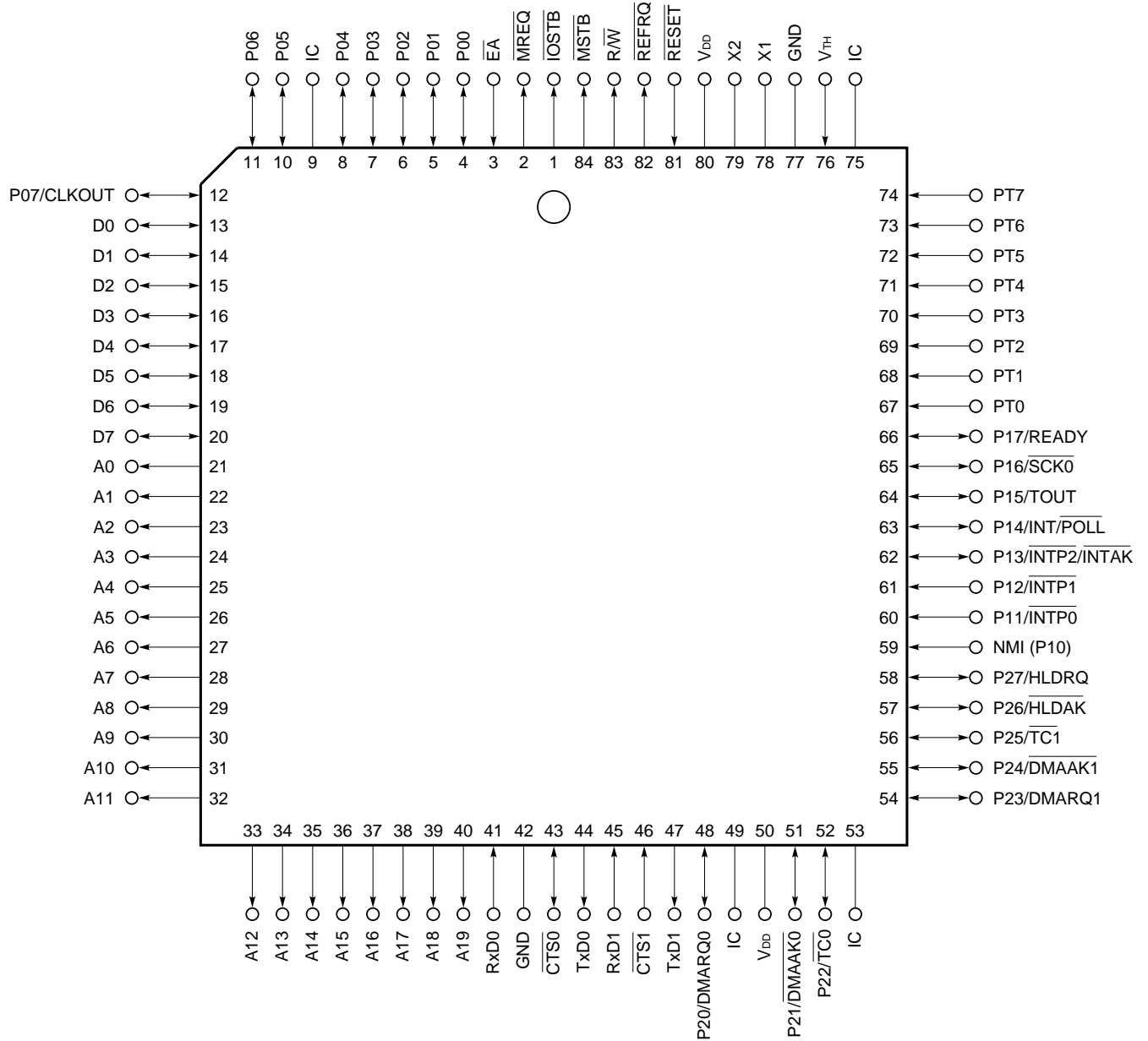

**Remark** IC: Internally Connected

- Cautions**
1. Fix IC pin individually to high level via a pull-up resistor externally.
  2. Fix EA pin to low level.

# INTERNAL BLOCK DIAGRAM

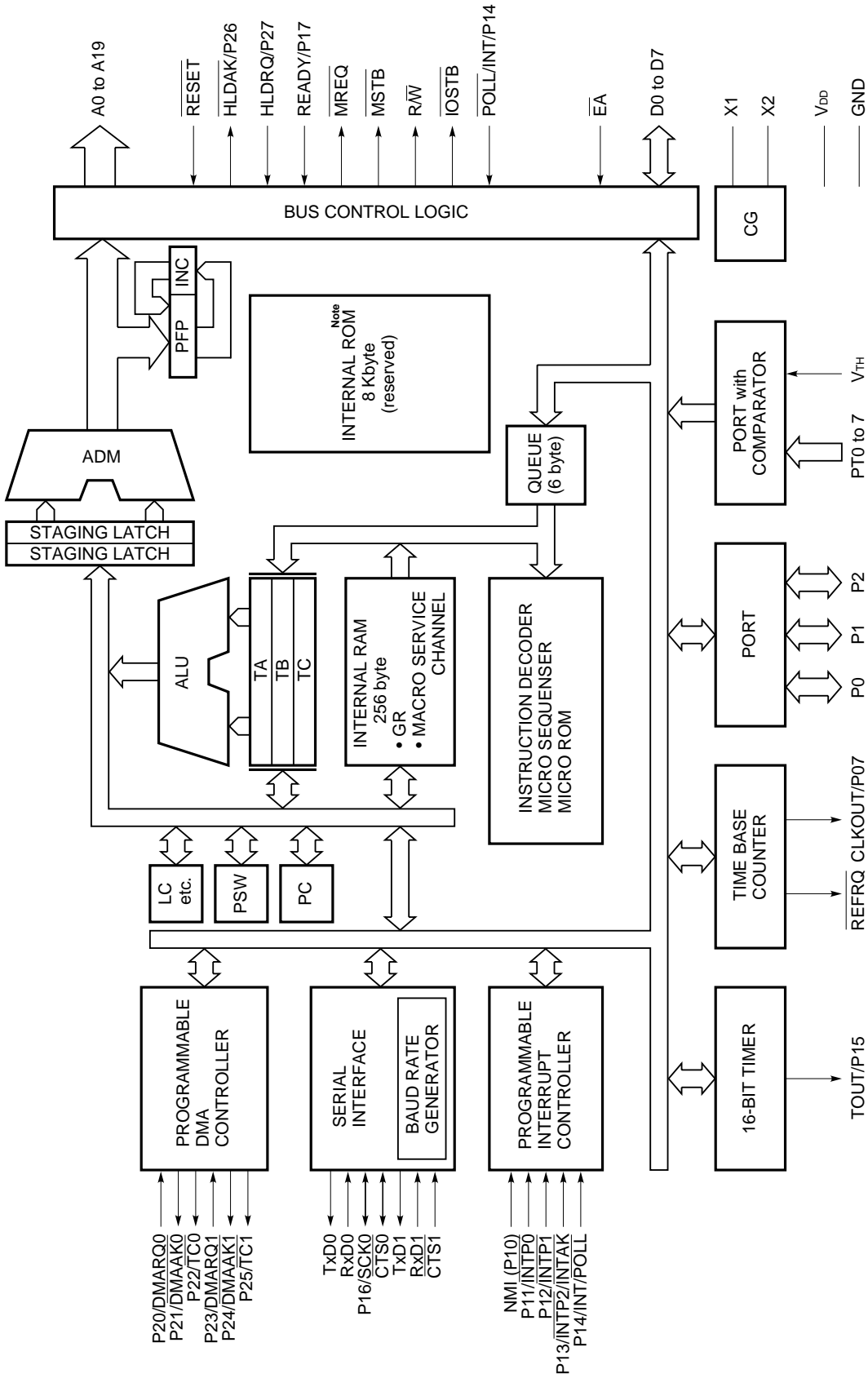

**Note** The internal ROM of 8 Kbytes is reserved for specific use such as testing and not user-accessible.

## CONTENTS

<b>1. PIN FUNCTIONS .....</b>	<b>8</b>
1.1 Port Pins .....	8
1.2 Non-port Pins .....	9
<b>2. INSTRUCTION SETS .....</b>	<b>10</b>
2.1 Comparison between $\mu$ PD70108 and 70116 .....	10
2.2 Instruction Set Operation .....	12
2.3 Instruction Set Table .....	16
2.4 Number of Clocks Table .....	38
<b>3. ELECTRICAL SPECIFICATIONS .....</b>	<b>49</b>
<b>4. PACKAGE DRAWINGS .....</b>	<b>74</b>
<b>5. RECOMMENDED SOLDERING CONDITIONS .....</b>	<b>76</b>

## 1. PIN FUNCTIONS

### 1.1 Port Pins

Pin Name	Input/Output	Port Function	Control Function	
P00 to P06	Input & output	8-bit input/output ports, each to be specified bit-by-bit	—	
P07/CLKOUT	Input & output/output		System clock output	
NMI (P10)	Input	Used as non-maskable interrupt request input (input port)	—	
P11/ $\overline{\text{INTP0}}$		Used as both external interrupt request input and input port		
P12/ $\overline{\text{INTP1}}$				
P13/ $\overline{\text{INTP2}}/\overline{\text{INTAK}}$	Input/input/output		INT acknowledge signal output	
P14/ $\overline{\text{POLL}}/\overline{\text{INT}}$	Input & output/input/input	Used as both specifiable input/output port and $\overline{\text{POLL}}$ input	External interrupt request input	
P15/TOUT	Input & output/output	Input/output port specifiable bit-by-bit	Timer output	
P16/ $\overline{\text{SCK0}}$			Serial clock output	
P17/READY	Input & output/input		READY input	
P20/DMARQ0	Input & output/input	8-bit input/output port specifiable bit-by-bit	DMA request input (CH0)	
P21/ $\overline{\text{DMAAK0}}$	Input & output/input		DMA acknowledge output (CH0)	
P22/ $\overline{\text{TC0}}$			DMA end output (CH0)	
P23/DMARQ1	Input & output/input		DMA request input (CH1)	
P24/ $\overline{\text{DMAAK1}}$	Input & output/output		DMA acknowledge output (CH1)	
P25/ $\overline{\text{TC1}}$			DMA end output (CH1)	
P26/ $\overline{\text{HLDAK}}$	Input & output/output		HOLD acknowledge output	
P27/ $\overline{\text{HLDRQ}}$	Input & output/input		HOLD input	
PT0 to PT7	Input		8-bit input port with comparator	—

**Remark** All port pins become input ports after reset is released.

When using P13/ $\overline{\text{INTP2}}/\overline{\text{INTAK}}$  as a  $\overline{\text{INTAK}}$  pin, be sure to pull up the pin to avoid a malfunction of external interrupt controller after reset is released.



1.2 Non-port Pins

Pin Name	Input/Output	Function
TxD0	Output	Serial data output
TxD1		
RxD0	Input	Serial data input
RxD1		
$\overline{\text{CTS0}}$	Input & output	CTS input in asynchronous mode, receive clock input/output in I/O interface mode
$\overline{\text{CTS1}}$	Input	CTS input
$\overline{\text{REFRQ}}$	Output	DRAM refresh pulse output
$V_{\text{TH}}$	Input	Comparator reference voltage input
$\overline{\text{RESET}}$		Reset signal input
$\overline{\text{EA}}$		Fix to low level
X1		Used to connect crystal resonator for oscillating system clock.
X2		External clock is entered by entering reverse phase clock to both X1 and X2 pins.
D0 to D7	Input & output	8-bit data bus
A0 to A19	Output	20-bit address output
$\overline{\text{MREQ}}$		Output used to indicate that memory bus cycle has been started
$\overline{\text{MSTB}}$		Memory read/memory write strobe output
$\text{R}/\overline{\text{W}}$		Read cycle/write cycle ID signal output
$\overline{\text{IOSTB}}$		I/O read/I/O write strobe output
$V_{\text{DD}}$		Positive power supply pins (all pins should be connected)
GND	GND pins (all pins should be connected)	
IC		Internally connected (fix to high level via a pull-up resistor externally)

**2. INSTRUCTION SETS**

★ The μPD70325 instruction sets are compatible with those of μPD70320.

**2.1 Comparison between μPD70108 and 70116**

The μPD70325 instruction sets are upward-compatible with those of μPD70108/70116 in native mode. The following instructions are newly added to the μPD70108/70116.

**(1) Conditional branch instruction**

- BTCLR ..... Bit test instruction used for special function registers

If, when this BTCLR is executed, the target special function register bit status is “1”, the bit is reset (0) and the program is branched to short-label described in the operand. If the target bit status is “0”, the program is moved to the next instruction. PSW is not changed in this instruction.

(Descriptive format)

Mnemonic	Operand		
	Special Function Register Address	Special Function Register Bit	Branch Address
BTCLR	sfr	imm3	short-label

**(2) Interrupt instructions**

- RETRBI ..... Return instruction used for register banks

This instruction is used to return the program from the interrupt service routine in which the register bank switching function is used. It cannot be used for returning from vectored interrupt servicing.

(Descriptive format)

Mnemonic	Operand
RETRBI	None

- FINT ..... This instruction is used to report the interrupt controller that interrupt servicing has ended. If an interrupt other than NMI, INT, and software interrupt is used, this instruction must be executed prior to the instruction for returning from interrupt servicing. It should not be used for NMI, INT and software interrupts.

(Descriptive format)

Mnemonic	Operand
FINT	None

**(3) CPU instruction**

- STOP ..... Instruction for transition to STOP state

(Descriptive format)

Mnemonic	Operand
STOP	None

**(4) Register bank switch instructions**

- BRKCS ..... Used to switch register banks

A register bank is switched to the register bank indicated by the lower 3 bits in the 16-bit register described in the operand. The program is also branched with this instruction to the address obtained from the PS stored in advance in the new register bank and the vector PC.

The RETRBI instruction is used to return the program from the new register bank.

(Descriptive format)

Mnemonic	Operand
BRKCS	reg16

- TSKSW ..... Used to switch register banks

Just like the BRKCS instruction, this instruction is also executed to select a register bank. The program is branched to the address obtained from the PS stored in advance in the new register bank and the address obtained from the PC save area.

(Descriptive format)

Mnemonic	Operand
TSKSW	reg16

**(5) Data transfer instructions**

- MOVSPA ... Used to transfer SS and SP values

This instruction is executed to transfer both SS and SP values before the register bank is switched to SS and SP of the current (post-switching) register bank.

(Descriptive format)

Mnemonic	Operand
MOVSPA	None

- MOVSPB ... Used to transfer SS and SP values

This instruction is executed to transfer the SS and SP values of the current (pre-switching) register bank to the SS and SP of the new register bank indicated by the lower 3 bits in the 16-bit register described in the operand.

(Descriptive format)

Mnemonic	Operand
MOVSPB	reg16

Some μPD70108/70116 instructions should be much cared as shown below when used for the μPD70325.

- I/O instruction, primitive I/O instruction

If PSW  $\overline{\text{IBRK}}$  flag is reset (0), an interrupt is generated without executing this instruction. Be sure to set (1) the  $\overline{\text{IBRK}}$  flag when using the I/O instruction.

- FPO instruction

An interrupt is generated without executing this instruction.

## 2.2 Instruction Set Operation

Table 2-1. Operand Identifier

Identifier	Description
reg, reg'	8-/16-bit general register
reg8, reg8'	8-bit general register
reg16, reg16'	16-bit general register
dmem	8-/16-bit memory location
mem	8-/16-bit memory location
mem8	8-bit memory location
mem16	16-bit memory location
mem32	32-bit memory location
sfr	8-bit special function register location
imm	Constant within 0 to FFFFH
imm3	Constant within 0 to 7
imm4	Constant within 0 to FH
imm8	Constant within 0 to FFH
imm16	Constant within 0 to FFFFH
acc	Register AW or AL
sreg	Segment register
src-table	256-byte conversion table name
src-block	Register IX-addressed block name
dst-block	Register IY-addressed block name
near-proc	Procedure in the current program segment
far-proc	Procedure in another program segment
near-label	Label in the current program segment
short-label	Label within end of instruction to -128 to +127 bytes
far-label	Label in another program segment
memptr16	Word including location offset in the current program segment to which control is to be passed
memptr32	Double-word including location offset in another program segment to which control is to be passed and segment base address
regptr16	16-bit general register including location offset in another program segment to which control is to be passed
pop-value	Number of bytes to be abandoned from stack (0 to 64K, normally even number)
fp-op	Immediate value to judge instruction code of external floating point operation chip
R	Register set

**Table 2-2. Operation Code Identifier**

Identifier	Description
W	Byte/word specification bit (0: byte, 1: word). However, when s = 1, the sign extended byte data should be 16-bit operand even when W is 1.
reg, reg'	Register field (000 to 111)
mem	Memory field (000 to 111)
mod	Mode field (00 to 10)
s	Sign extension specification bit (0: Sign is not extended, 1: Sign is extended)
X, XXX, YYY, ZZZ	Data used to judge instruction code of external floating-point operation chip

**Table 2-3. Operation Identifier (1/2)**

Identifier	Description
AW	Accumulator (16 bits)
AH	Accumulator (upper byte)
AL	Accumulator (lower byte)
BW	Register BW (16 bits)
CW	Register CW (16 bits)
CL	Register CW (lower byte)
DW	Register DW (16 bits)
SP	Stack pointer (16 bits)
PC	Program counter (16 bits)
PSW	Program status word (16 bits)
IX	Index register (source) (16 bits)
IY	Index register (destination) (16 bits)
PS	Program segment register (16 bits)
DS1	Data segment 1 register (16 bits)
DS0	Data segment 0 register (16 bits)
SS	Stack segment register (16 bits)
AC	Auxiliary carry flag
CY	Carry flag
P	Parity flag
S	Sign flag
Z	Zero flag
DIR	Direction flag
IE	Interrupt enable flag
V	Overflow flag
BRK	Break flag
(...)	Contents in memory shown in ( )
disp	Displacement (8/16 bits)
ext-disp8	16 bits obtained by extending sign of 8-bit displacement

**Table 2-3. Operation Identifier (2/2)**

Identifier	Description
temp	Temporary register (8/16/32 bits)
tmpcy	Temporary carry flag (1 bit)
seg	Immediate segment data (16 bits)
offset	Immediate offset data (16 bits)
←	Transfer direction
+	Addition
-	Subtraction
×	Multiplication
÷	Division
%	Modulo
^	AND
∨	OR
⊕	Exclusive OR
xxH	2-digit hexadecimal number
xxxxH	4-digit hexadecimal number

**Table 2-4. Flag Operation Identifier**

Identifier	Description
(Blank)	No change
0	Cleared to 0
1	Set to 1
×	Set or cleared according to the result
U	Not defined
R	The previously saved value is restored.

**Table 2-5. Memory Addressing**

mem \ mod	0 0	0 1	1 0
0 0 0	BW + IX	BW + IX + disp 8	BW + IX + disp 16
0 0 1	BW + IY	BW + IY + disp 8	BW + IY + disp 16
0 1 0	BP + IX	BP + IX + disp 8	BP + IX + disp 16
0 1 1	BP + IY	BP + IY + disp 8	BP + IY + disp 16
1 0 0	IX	IX + disp 8	IX + disp 16
1 0 1	IY	IY + disp 8	IY + disp 16
1 1 0	DIRECT ADDRESS	BP + disp 8	BP + disp 16
1 1 1	BW	BW + disp 8	BW + disp 16

**Table 2-6. 8/16-Bit General Register Selection**

reg, reg'	W = 0	W = 1
000	AL	AW
001	CL	CW
010	DL	DW
011	BL	BW
100	AH	SP
101	CH	BP
110	DH	IX
111	BH	IY

**Table 2-7. Segment Register Selection**

sreg	
00	DS1
01	PS
10	SS
11	DS0

### 2.3 Instruction Set Table

Group	Mnemonic	Operand	Operation Code										Bytes	Operation	Flags												
			7	6	5	4	3	2	1	0	7	6			5	4	3	2	1	0	AC	CY	V	P	S	Z	
Data transfer	MOV	reg,reg'	1	0	0	0	1	0	1	W	1	1	reg	reg'	2	reg ← reg'											
		mem,reg	1	0	0	0	1	0	0	W	mod	reg	mem	2 to 4	(mem) ← reg												
		reg,mem	1	0	0	0	1	0	1	W	mod	reg	mem	2 to 4	reg ← (mem)												
		mem,imm	1	1	0	0	0	1	1	W	mod	0	0	0	mem	3 to 6	(mem) ← imm										
		reg,imm	1	0	1	1	W	reg	2 to 3	reg ← imm																	
		acc,dmem	1	0	1	0	0	0	0	W	3	When W = 0, AL ← (dmem) When W = 1, AH ← (dmem + 1), AL ← (dmem)															
		dmem,acc	1	0	1	0	0	0	1	W	3	When W = 0, (dmem) ← AL When W = 1, (dmem + 1) ← AH, (dmem) ← AL															
		sreg,reg16	1	0	0	0	1	1	0	1	1	0	sreg	reg	2	sreg ← reg16											
		sreg,mem16	1	0	0	0	1	1	0	mod	0	sreg	mem	2 to 4	sreg ← (mem16)												
		reg16,sreg	1	0	0	0	1	1	0	1	1	0	sreg	reg	2	reg16 ← sreg											
LDEA	mem16,sreg	mem16,sreg	1	0	0	0	1	1	0	mod	0	sreg	mem	2 to 4	(mem16) ← sreg												
		DS0,reg16,mem32	1	1	0	0	0	1	0	mod	reg	mem	2 to 4	reg16 ← (mem32) DS0 ← (mem32 + 2)													
TRANS	XCH	DS1,reg16,mem32	1	1	0	0	0	1	0	mod	reg	mem	2 to 4	reg16 ← (mem32) DS1 ← (mem32 + 2)													
		AH,PSW	1	0	0	1	1	1	1	1	AH ← S, Z, F1, AC, F0, P, I $\overline{B}$ RK, CY																
LDEA	reg16,mem16	PSW,AH	1	0	0	1	1	1	0	1	S, Z, F1, AC, F0, P, I $\overline{B}$ RK, CY ← AH																
		reg16,mem16	1	0	0	0	1	1	0	mod	reg	mem	2 to 4	reg16 ← mem16													
XCH	reg,reg'	src-table	1	1	0	1	0	1	1	1	AL ← (BW + AL)																
		reg,reg'	1	0	0	0	1	1	W	2	reg ↔ reg'																
MOVSPA <sup>Note</sup>	reg,mem	mem,reg	1	0	0	0	1	1	W	mod	reg	mem	2 to 4	(mem) ↔ reg													
		AW,reg16	1	0	0	1	0	reg	1	AW ↔ reg16																	
MOVSPB <sup>Note</sup>	reg16	reg16,AW	0	0	0	0	1	1	1	0	0	1	0	1	2	New register bank SS and SP ← old register bank SS and SP											
		reg16	0	0	0	0	1	1	1	1	0	0	1	0	1	3	SS and SP of reg16-indicated new register bank ← old register bank SS and SP										

**Note** These instructions are newly added to the  $\mu$ PD70108/70116.



Group	Mnemonic	Operand	Operation Code										Bytes	Operation	Flags										
			7	6	5	4	3	2	1	0	7	6			5	4	3	2	1	0	AC	CY	V	P	S
Repeat prefix	REPC		0	1	1	0	0	1	0	1	0	1	1	Executes the primitive block transfer instruction in the continued byte while CW ≠ 0, and decrements CW by one. If any interruption is held at this time, it is processed. The program exits the loop when CY ≠ 1.											
	REPNC		0	1	1	0	0	1	0	0	1	1	Same as above. The program exits the loop when CY ≠ 0.												
	REP		1	1	1	1	0	0	1	1	1	Executes the primitive block transfer instruction in the continued byte while CW ≠ 0, and decrements CW by one. If any interruption is held at this time, it is processed. The program exits the loop when the primitive block transfer instruction is CMPBK or CMPM, and when Z ≠ 1.													
	REPNE		1	1	1	1	0	0	1	0	1	Same as above.													
	REPZ		1	1	1	1	0	0	1	0	1	The program exits the loop when Z ≠ 0.													
Primitive block transfer	MOVBK	dst-block, src-block	1	0	1	0	0	1	0	1	0	W	1	When W = 0, (IY) ← (IX) DIR = 0: IX ← IX + 1, IY ← IY + 1 DIR = 1: IX ← IX - 1, IY ← IY - 1											
	CMPBK	src-block, dst-block	1	0	1	0	0	1	1	1	W	1	When W = 1, (IY + 1, IY) ← (IX + 1, IX) DIR = 0: IX ← IX + 2, IY ← IY + 2 DIR = 1: IX ← IX - 2, IY ← IY - 2												
		dst-block	1	0	1	0	0	1	1	1	W	1	When W = 0, (IX) ← (IY) DIR = 0: IX ← IX + 1, IY ← IY + 1 DIR = 1: IX ← IX - 1, IY ← IY - 1	x	x	x	x	x	x						
	CMPM	dst-block	1	0	1	0	1	1	1	1	W	1	When W = 1, (IX + 1, IX) ← (IY + 1, IY) DIR = 0: IX ← IX + 2, IY ← IY + 2 DIR = 1: IX ← IX - 2, IY ← IY - 2												
		dst-block	1	0	1	0	1	1	1	1	W	1	When W = 0, AL ← (IY) DIR = 0: IY ← IY + 1; DIR = 1: IY ← IY - 1	x	x	x	x	x	x						
	LDM	src-block	1	0	1	0	1	1	0	W	1	When W = 1, AW ← (IY + 1, IY) DIR = 0: IY ← IY + 2; DIR = 1: IY ← IY - 2													
		dst-block	1	0	1	0	1	1	0	W	1	When W = 0, AL ← (IX) DIR = 0: IX ← IX + 1; DIR = 1: IX ← IX - 1													
		dst-block	1	0	1	0	1	0	1	W	1	When W = 1, AW ← (IX + 1, IX) DIR = 0: IX ← IX + 2; DIR = 1: IX ← IX - 2													
	STM	dst-block	1	0	1	0	1	0	1	W	1	When W = 0, (IY) ← AL DIR = 0: IY ← IY + 1; DIR = 1: IY ← IY - 1													
		dst-block	1	0	1	0	1	0	1	W	1	When W = 1, (IY + 1, IY) ← AW DIR = 0: IY ← IY + 2; DIR = 1: IY ← IY - 2													

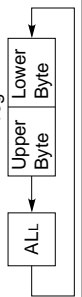
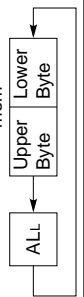
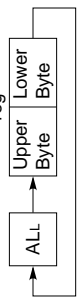
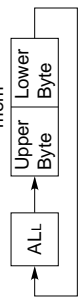

Group	Mnemonic	Operand	Operation Code										Bytes	Operation	Flags								
			7	6	5	4	3	2	1	0	7	6			5	4	3	2	1	0	AC	CY	V
Addition/ subtraction	ADD	reg,reg'	0	0	0	0	0	0	1	W	1	1	reg	reg'	2	reg ← reg + reg'	x	x	x	x	x	x	
		mem,reg	0	0	0	0	0	0	0	W	mod	reg	mem		2 to 4	(mem) ← (mem) + reg	x	x	x	x	x	x	
		reg,mem	0	0	0	0	0	0	1	W	mod	reg	mem		2 to 4	reg ← reg + (mem)	x	x	x	x	x	x	
		reg,imm	1	0	0	0	0	0	s	W	1	1	0	0	reg	3 to 4	reg ← reg + imm	x	x	x	x	x	x
		mem,imm	1	0	0	0	0	0	s	W	mod	0	0	0	mem	3 to 6	(mem) ← (mem) + imm	x	x	x	x	x	x
		acc,imm	0	0	0	0	1	0	W						2 to 3	When W = 0, AL ← AL + imm When W = 1, AW ← AW + imm	x	x	x	x	x	x	
		reg,reg'	0	0	1	0	0	1	W	1	1	reg	reg'	2	reg ← reg + reg' + CY	x	x	x	x	x	x		
		mem,reg	0	0	1	0	0	0	W	mod	reg	mem			2 to 4	(mem) ← (mem) + reg + CY	x	x	x	x	x	x	
		reg,mem	0	0	1	0	0	1	W	mod	reg	mem			2 to 4	reg ← reg + (mem) + CY	x	x	x	x	x	x	
		reg,imm	1	0	0	0	0	s	W	1	1	0	1	reg	3 to 4	reg ← reg + imm + CY	x	x	x	x	x	x	
	ADDC	mem,imm	1	0	0	0	0	s	W	mod	0	1	0	mem	3 to 6	(mem) ← (mem) + imm + CY	x	x	x	x	x	x	
		acc,imm	0	0	1	0	1	0	W						2 to 3	When W = 0, AL ← AL + imm + CY When W = 1, AW ← AW + imm + CY	x	x	x	x	x	x	
		reg,reg'	0	0	1	0	1	W	1	1	reg	reg'	2	reg ← reg - reg'	x	x	x	x	x	x			
		mem,reg	0	0	1	0	1	0	W	mod	reg	mem			2 to 4	(mem) ← (mem) - reg	x	x	x	x	x	x	
		reg,mem	0	0	1	0	1	1	W	mod	reg	mem			2 to 4	reg ← reg - (mem)	x	x	x	x	x	x	
		reg,imm	1	0	0	0	0	s	W	1	1	1	0	reg	3 to 4	reg ← reg - imm	x	x	x	x	x	x	
		mem,imm	1	0	0	0	0	s	W	mod	1	0	1	mem	3 to 6	(mem) ← (mem) - imm	x	x	x	x	x	x	
		acc,imm	0	0	1	0	1	0	W						2 to 3	When W = 0, AL ← AL - imm When W = 1, AW ← AW - imm	x	x	x	x	x	x	
		reg,reg'	0	0	1	0	1	W	1	1	reg	reg'	2	reg ← reg - reg' - CY	x	x	x	x	x	x			
		mem,reg	0	0	1	0	0	W	mod	reg	mem			2 to 4	(mem) ← (mem) - reg - CY	x	x	x	x	x	x		
	SUBC	reg,mem	0	0	1	0	1	W	mod	reg	mem			2 to 4	reg ← reg - (mem) - CY	x	x	x	x	x	x		
		reg,imm	1	0	0	0	0	s	W	1	1	0	1	reg	3 to 4	reg ← reg - imm - CY	x	x	x	x	x	x	
		mem,imm	1	0	0	0	0	s	W	mod	0	1	1	mem	3 to 6	(mem) ← (mem) - imm - CY	x	x	x	x	x	x	
		acc,imm	0	0	1	1	0	W						2 to 3	When W = 0, AL ← AL - imm - CY When W = 1, AW ← AW - imm - CY	x	x	x	x	x	x		

Group	Mnemonic	Operand	Operation Code								Bytes	Operation	Flags														
			7	6	5	4	3	2	1	0			7	6	5	4	3	2	1	0	AC	CY	V	P	S	Z	
BCD operation	ADD4S		0	0	0	0	1	1	1	1	0	0	1	0	0	0	0	0	2	dst BCD string ← dst BCD string + src BCD string	U	x	U	U	U	x	
	SUB4S		0	0	0	0	1	1	1	1	0	0	1	0	0	0	1	0	2	dst BCD string ← dst BCD string – src BCD string	U	x	U	U	U	x	
	CMP4S		0	0	0	0	1	1	1	1	0	0	1	0	0	1	1	0	2	dst BCD string – src BCD string	U	x	U	U	U	x	
ROL4	ROL4	reg8	0	0	0	0	1	1	1	1	0	0	1	0	1	0	0	0	3								
		mem8	0	0	0	0	1	1	1	1	0	0	1	0	1	0	0	0	3 to 5								
	ROR4	reg8	0	0	0	0	1	1	1	1	0	0	1	0	1	0	1	0	3								
		mem8	0	0	0	0	1	1	1	1	0	0	1	0	1	0	1	0	3 to 5								
Increment/decrement	INC	reg8	1	1	1	1	1	1	0	1	1	0	0	0	0	0	0	2	reg8 ← reg8 + 1	x	x	x	x	x	x		
		mem	1	1	1	1	1	1	1	W	mod	0	0	0	0	0	0	0	2 to 4	(mem) ← (mem) + 1	x	x	x	x	x	x	
		reg16	0	1	0	0	0	0	0	0	reg								1	reg16 ← reg16 + 1	x	x	x	x	x	x	
	DEC	reg8	1	1	1	1	1	1	0	1	1	0	0	1	0	0	0	2	reg8 ← reg8 – 1	x	x	x	x	x	x		
		mem	1	1	1	1	1	1	1	W	mod	0	0	0	1	0	0	0	2 to 4	(mem) ← (mem) – 1	x	x	x	x	x	x	
		reg16	0	1	0	0	1	0	0	0	reg								1	reg16 ← reg16 – 1	x	x	x	x	x	x	

**Note** The number of BCD digits is given in the CL register. The value can be set within 1 to 254.

Group	Mnemonic	Operand	Operation Code										Bytes	Operation	Flags									
															AC	CY	V	P	S	Z				
			7	6	5	4	3	2	1	0	7	6									5	4	3	2
Multipli- cation	MULU	reg8	1	1	1	1	0	1	1	0	1	1	1	0	0	reg	2	AW ← AL × reg8 AH = 0: CY ← 0, V ← 0 AH ≠ 0: CY ← 1, V ← 1	U	x	x	U	U	U
		mem8	1	1	1	1	0	1	1	0	mod	1	0	0	mem	2 to 4	AW ← AL × (mem8) AH = 0: CY ← 0, V ← 0 AH ≠ 0: CY ← 1, V ← 1	U	x	x	U	U	U	
		reg16	1	1	1	1	0	1	1	1	1	1	1	0	0	reg	2	DW, AW ← AW × reg16 DW = 0: CY ← 0, V ← 0 DW = 1: CY ← 1, V ← 1	U	x	x	U	U	U
		mem16	1	1	1	1	0	1	1	1	mod	1	0	0	mem	2 to 4	DW, AW ← AW × (mem16) DW = 0: CY ← 0, V ← 0 DW = 1: CY ← 1, V ← 1	U	x	x	U	U	U	
	MUL	reg8	1	1	1	1	0	1	1	0	1	1	1	0	1	reg	2	AW ← AL × reg8 Extension of AH = AL sign: CY ← 0, V ← 0 Extension of AH ≠ AL sign: CY ← 1, V ← 1	U	x	x	U	U	U
		mem8	1	1	1	1	0	1	1	0	mod	1	0	1	mem	2 to 4	AW ← AL × (mem8) Extension of AH = AL sign: CY ← 0, V ← 0 Extension of AH ≠ AL sign: CY ← 1, V ← 1	U	x	x	U	U	U	
		reg16	1	1	1	1	0	1	1	1	1	1	1	0	1	reg	2	DW, AW ← AW × reg16 Extension of DW = AW sign: CY ← 0, V ← 0 Extension of DW ≠ AW sign: CY ← 1, V ← 1	U	x	x	U	U	U
		mem16	1	1	1	1	0	1	1	1	mod	1	0	1	mem	2 to 4	DW, AW ← AW × (mem16) Extension of DW = AW sign: CY ← 0, V ← 0 Extension of DW ≠ AW sign: CY ← 1, V ← 1	U	x	x	U	U	U	
		reg16, (reg16), <sup>Note</sup> imm8	0	1	1	0	1	0	1	1	1	1	reg	reg'	3	reg16 ← reg16' × imm8 Product ≤ 16 bits: CY ← 0, V ← 0 Product > 16 bits: CY ← 1, V ← 1	U	x	x	U	U	U		
		reg16, mem16, imm8	0	1	1	0	1	0	1	1	mod	reg	mem	3 to 5	reg16 ← (mem16) × imm8 Product ≤ 16 bits: CY ← 0, V ← 0 Product > 16 bits: CY ← 1, V ← 1	U	x	x	U	U	U			
reg16, (reg16), <sup>Note</sup> imm16	0	1	1	0	1	0	0	1	1	1	reg	reg'	4	reg16 ← reg16' × imm16 Product ≤ 16 bits: CY ← 0, V ← 0 Product > 16 bits: CY ← 1, V ← 1	U	x	x	U	U	U				
reg16, mem16, imm16	0	1	1	0	1	0	0	1	mod	reg	mem	4 to 6	reg16 ← (mem16) × imm16 Product ≤ 16 bits: CY ← 0, V ← 0 Product > 16 bits: CY ← 1, V ← 1	U	x	x	U	U	U					

**Note** The 2nd operand is omissible. If omitted, the 1st operand is assumed.

Group	Mnemonic	Operand	Operation Code				Bytes	Operation	Flags														
			7	6	5	4			3	2	1	0	AC	CY	V	P	S	Z					
Unsign- ed division	DIVU	reg8	1	1	1	0	1	1	0	1	1	0	reg	2	temp ← AW When temp + reg8 ≤ FFH AH ← temp%reg8, AL ← temp + reg8 When temp + reg8 > FFH (SP - 1, SP - 2) ← PSW, (SP - 3, SP - 4) ← PS (SP - 5, SP - 6) ← PC, SP ← SP - 6 IE ← 0, BRK ← 0, PS ← (3, 2), PC ← (1, 0)	U	U	U	U	U	U		
			1	1	1	0	1	1	0	mod	1	1	0	mem	2 to 4	temp ← AW When temp + (mem8) ≤ FFH AH ← temp%(mem8), AL ← temp + (mem8) When temp + (mem8) > FFH (SP - 1, SP - 2) ← PSW, (SP - 3, SP - 4) ← PS (SP - 5, SP - 6) ← PC, SP ← SP - 6 IE ← 0, BRK ← 0, PS ← (3, 2), PC ← (1, 0)	U	U	U	U	U	U	
			1	1	1	0	1	1	1	1	1	1	1	0	reg	2	temp ← DW, AW When temp + reg16 ≤ FFFFH DW ← temp%reg16, AW ← temp + reg16 When temp + reg16 > FFFFH (SP - 1, SP - 2) ← PSW, (SP - 3, SP - 4) ← PS (SP - 5, SP - 6) ← PC, SP ← SP - 6 IE ← 0, BRK ← 0, PS ← (3, 2), PC ← (1, 0)	U	U	U	U	U	U
			1	1	1	0	1	1	1	1	mod	1	1	0	mem	2 to 4	temp ← DW, AW When temp + (mem16) ≤ FFFFH DW ← temp%(mem16), AW ← temp + (mem16) When temp + (mem16) > FFFFH (SP - 1, SP - 2) ← PSW, (SP - 3, SP - 4) ← PS (SP - 5, SP - 6) ← PC, SP ← SP - 6 IE ← 0, BRK ← 0, PS ← (3, 2), PC ← (1, 0)	U	U	U	U	U	U

Group	Mnemonic	Operand	Operation Code								Bytes	Operation	Flags							
			7	6	5	4	3	2	1	0			AC	CY	V	P	S	Z		
Signed division	DIV	reg8	1 1 1 1 0 1 1 0	1 1 1 1 1 1 1 0	7	6	5	4	3	2	1	0	2	temp ← AW When temp + reg8 > 0 and temp + reg8 ≤ 7FH or temp + reg8 < 0 and temp + reg8 > 0 - 7FH - 1 AH ← temp%reg8, AL ← temp + reg8 When temp + reg8 > 0 and temp + reg8 > 7FH or temp + reg8 < 0 and temp + reg8 < 0 - 7FH - 1 (SP - 1, SP - 2) ← PSW, (SP - 3, SP - 4) ← PS (SP - 5, SP - 6) ← PC, SP ← SP - 6 IE ← 0, BRK ← 0, PS ← (3, 2), PC ← (1, 0)	U	U	U	U	U	U
			1 1 1 1 0 1 1 0	mod 1 1 1 1 mem	2 to 4	temp ← AW When temp + (mem8) > 0 and temp + (mem8) ≤ 7FH or temp + (mem8) < 0 and temp + (mem8) > 0 - 7FH - 1 AH ← temp%(mem8), AL ← temp + (mem8) When temp + (mem8) > 0 and temp + (mem8) > 7FH or temp + (mem8) < 0 and temp + (mem8) < 0 - 7FH - 1 (SP - 1, SP - 2) ← PSW, (SP - 3, SP - 4) ← PS (SP - 5, SP - 6) ← PC, SP ← SP - 6 IE ← 0, BRK ← 0, PS ← (3, 2), PC ← (1, 0)	U	U	U	U	U	U								
		reg16	1 1 1 1 0 1 1 1	1 1 1 1 1 1 1 1	2	temp ← DW, AW When temp + reg16 > 0 and temp + reg16 ≤ 7FFFH or temp + reg16 < 0 and temp + reg16 > 0 - 7FFFH - 1 DW ← temp%reg16, AW ← temp + reg16 When temp + reg16 > 0 and temp + reg16 > 7FFFH or temp + reg16 < 0 and temp + reg16 < 0 - 7FFFH - 1 (SP - 1, SP - 2) ← PSW, (SP - 3, SP - 4) ← PS (SP - 5, SP - 6) ← PC, SP ← SP - 6 IE ← 0, BRK ← 0, PS ← (3, 2), PC ← (1, 0)	U	U	U	U	U	U								
		mem16	1 1 1 1 0 1 1 1	mod 1 1 1 1 mem	2 to 4	temp ← DW, AW When temp + (mem16) > 0 and temp + (mem16) ≤ 7FFFH or temp + (mem16) < 0 and temp + (mem16) > 0 - 7FFFH - 1 DW ← temp%(mem16), AW ← temp + (mem16) When temp + (mem16) > 0 and temp + (mem16) > 7FFFH or temp + (mem16) < 0 and temp + (mem16) < 0 - 7FFFH - 1 (SP - 1, SP - 2) ← PSW, (SP - 3, SP - 4) ← PS (SP - 5, SP - 6) ← PC, SP ← SP - 6 IE ← 0, BRK ← 0, PS ← (3, 2), PC ← (1, 0)	U	U	U	U	U	U								

Group	Mnemonic	Operand	Operation Code										Bytes	Operation	Flags																	
			7	6	5	4	3	2	1	0	7	6			5	4	3	2	1	0	AC	CY	V	P	S	Z						
BCD adjustment	ADJBA		0	0	1	1	0	1	1	1	1													1	When AL $\wedge$ 0FH > 9 or AC = 1, AL $\leftarrow$ AL + 6 AH $\leftarrow$ AH + 1, AC $\leftarrow$ 1, CY $\leftarrow$ AC, AL $\leftarrow$ AL $\wedge$ 0FH	x	x	U	U	U	U	
	ADJ4A		0	0	1	0	0	1	1	1	1													1	When AL $\wedge$ 0FH > 9 or AC = 1, AL $\leftarrow$ AL + 6, AC $\leftarrow$ 1 When AL > 9FH or CY = 1, AL $\leftarrow$ AL + 60H, CY $\leftarrow$ 1	x	x	U	x	x	x	
Data conversion	ADJBS		0	0	1	1	1	1	1	1	1													1	When AL $\wedge$ 0FH > 9 or AC = 1, AL $\leftarrow$ AL - 6, AH $\leftarrow$ AH - 1, AC $\leftarrow$ 1 CY $\leftarrow$ AC, AL $\leftarrow$ AL $\wedge$ 0FH	x	x	U	U	U	U	
	ADJ4S		0	0	1	0	1	1	1	1	1													1	When AL $\wedge$ 0FH > 9 or AC = 1, AL $\leftarrow$ AL - 6, AC $\leftarrow$ 1 When AL > 9FH or CY = 1, AL $\leftarrow$ AL - 60H, CY $\leftarrow$ 1	x	x	U	x	x	x	
	CVTBD		1	1	0	1	0	1	0	0	0	0	0	0	0	1	0	1	0	1	0	1	0	2	AH $\leftarrow$ AL $\div$ 0AH, AL $\leftarrow$ AL%0AH	U	U	U	x	x	x	
	CVTDB		1	1	0	1	0	1	0	1	0	0	0	0	0	1	0	1	0	1	0	1	0	2	AL $\leftarrow$ AH $\times$ 0AH + AL, AH $\leftarrow$ 0	U	U	U	x	x	x	
Compare	CVTBW		1	0	0	1	1	0	0	0	0													1	When AL < 80H, AH $\leftarrow$ 0. In other cases, AH $\leftarrow$ FFH.							
	CVTWL		1	0	0	1	1	0	0	1	0													1	When AW < 8000H, DW $\leftarrow$ 0. In other cases, DW $\leftarrow$ FFFFH.							
	CMP	reg,reg'		0	0	1	1	0	1	0	1	W	1	1	reg	reg'	2	reg - reg'	x	x	x	x	x	x								
		mem,reg		0	0	1	1	0	0	W	mod	reg	mem	2 to 4	(mem) - reg	x	x	x	x	x	x											
reg,mem			0	0	1	1	0	1	W	mod	reg	mem	2 to 4	reg - (mem)	x	x	x	x	x	x												
reg,imm			1	0	0	0	0	s	W	1	1	1	1	reg	3 to 4	reg - imm	x	x	x	x	x	x										
Complete operation	mem,imm		1	0	0	0	0	s	W	mod	1	1	1	mem	3 to 6	(mem) - imm	x	x	x	x	x	x										
	acc,imm		0	0	1	1	1	0	W					2 to 3	When W = 0, AL - imm When W = 1, AW - imm	x	x	x	x	x	x											
	reg		1	1	1	0	1	1	W	1	1	0	1	reg	2	reg $\leftarrow$ $\overline{\text{reg}}$																
	mem		1	1	1	0	1	1	W	mod	0	1	0	mem	2 to 4	(mem) $\leftarrow$ $\overline{\text{(mem)}}$																
NEG	reg		1	1	1	0	1	1	W	1	1	0	1	reg	2	reg $\leftarrow$ $\overline{\text{reg}} + 1$	x	x	x	x	x	x										
	mem		1	1	1	0	1	1	W	mod	0	1	1	mem	2 to 4	(mem) $\leftarrow$ $\overline{\text{(mem)}} + 1$	x	x	x	x	x	x										



Group	Mnemonic	Operand	Operation Code										Bytes	Operation	Flags										
			7	6	5	4	3	2	1	0	7	6			5	4	3	2	1	0	AC	CY	V	P	S
Logical operation	TEST	reg,reg'	1	0	0	0	1	0	W	1	1	reg'	reg	2	reg $\wedge$ reg'	U	0	0	0	X	X	X	X		
		mem,reg reg,mem	1	0	0	0	1	0	W	mod	reg	mem	2 to 4	(mem) $\wedge$ reg	U	0	0	0	X	X	X	X			
		reg,imm	1	1	1	0	1	1	W	1	1	0	0	reg	3 to 4	reg $\wedge$ imm	U	0	0	0	X	X	X	X	
		mem,imm	1	1	1	0	1	1	W	mod	0	0	0	mem	3 to 6	(mem) $\wedge$ imm	U	0	0	0	X	X	X	X	
		acc,imm	1	0	1	0	1	0	W				2 to 3	When W = 0, AL $\wedge$ imm8 When W = 1, AW $\wedge$ imm16	U	0	0	0	X	X	X	X			
	AND	reg,reg'	0	0	1	0	0	0	1	W	1	1	reg'	reg'	2	reg $\leftarrow$ reg $\wedge$ reg'	U	0	0	0	X	X	X	X	
		mem,reg	0	0	1	0	0	0	0	W	mod	reg	mem	2 to 4	(mem) $\leftarrow$ (mem) $\wedge$ reg	U	0	0	0	X	X	X	X		
		reg,mem	0	0	1	0	0	0	1	W	mod	reg	mem	2 to 4	reg $\leftarrow$ reg $\wedge$ (mem)	U	0	0	0	X	X	X	X		
		reg,imm	1	0	0	0	0	0	0	W	1	1	0	0	reg	3 to 4	reg $\leftarrow$ reg $\wedge$ imm	U	0	0	0	X	X	X	X
		mem,imm	1	0	0	0	0	0	0	W	mod	1	0	0	mem	3 to 6	(mem) $\leftarrow$ (mem) $\wedge$ imm	U	0	0	0	X	X	X	X
OR	acc,imm	0	0	1	0	0	1	0	W			2 to 3	When W = 0, AL $\leftarrow$ AL $\wedge$ imm8 When W = 1, AW $\leftarrow$ AW $\wedge$ imm16	U	0	0	0	X	X	X	X				
	reg,reg'	0	0	0	0	1	0	1	W	1	1	reg'	reg'	2	reg $\leftarrow$ reg $\vee$ reg'	U	0	0	0	X	X	X	X		
	mem,reg	0	0	0	0	1	0	0	W	mod	reg	mem	2 to 4	(mem) $\leftarrow$ (mem) $\vee$ reg	U	0	0	0	X	X	X	X			
	reg,mem	0	0	0	0	1	0	1	W	mod	reg	mem	2 to 4	reg $\leftarrow$ reg $\vee$ (mem)	U	0	0	0	X	X	X	X			
	reg,imm	1	0	0	0	0	0	0	W	1	1	0	0	1	reg	3 to 4	reg $\leftarrow$ reg $\vee$ imm	U	0	0	0	X	X	X	X
XOR	mem,imm	1	0	0	0	0	0	0	W	mod	0	0	0	1	mem	3 to 6	(mem) $\leftarrow$ (mem) $\vee$ imm	U	0	0	0	X	X	X	X
	acc,imm	0	0	0	0	1	1	0	W			2 to 3	When W = 0, AL $\leftarrow$ AL $\vee$ imm8 When W = 1, AW $\leftarrow$ AW $\vee$ imm16	U	0	0	0	X	X	X	X				
	reg,reg'	0	0	1	1	0	0	1	W	1	1	reg'	reg'	2	reg $\leftarrow$ reg $\vee$ reg'	U	0	0	0	X	X	X	X		
	mem,reg	0	0	1	1	0	0	0	W	mod	reg	mem	2 to 4	(mem) $\leftarrow$ (mem) $\vee$ reg	U	0	0	0	X	X	X	X			
	reg,mem	0	0	1	1	0	0	1	W	mod	reg	mem	2 to 4	reg $\leftarrow$ reg $\vee$ (mem)	U	0	0	0	X	X	X	X			
	reg,imm	1	0	0	0	0	0	0	W	1	1	1	0	reg	3 to 4	reg $\leftarrow$ reg $\vee$ imm	U	0	0	0	X	X	X	X	
	mem,imm	1	0	0	0	0	0	0	W	mod	1	1	0	mem	3 to 6	(mem) $\leftarrow$ (mem) $\vee$ imm	U	0	0	0	X	X	X	X	
	acc,imm	0	0	1	1	0	1	0	W			2 to 3	When W = 0, AL $\leftarrow$ AL $\vee$ imm8 When W = 1, AW $\leftarrow$ AW $\vee$ imm16	U	0	0	0	X	X	X	X				
	reg,imm	1	0	0	0	0	0	0	W	1	1	1	0	reg	3 to 4	reg $\leftarrow$ reg $\vee$ imm	U	0	0	0	X	X	X	X	
	mem,imm	1	0	0	0	0	0	0	W	mod	1	1	0	mem	3 to 6	(mem) $\leftarrow$ (mem) $\vee$ imm	U	0	0	0	X	X	X	X	



Group	Mnemonic	Operand	Operation Code										Bytes	Operation	Flags									
			7	6	5	4	3	2	1	0	7	6			5	4	3	2	1	0	AC	CY	V	P
Bit manipulation	CLR1	reg8,CL	0	0	0	1	0	0	1	0	1	1	0	0	0	reg	3	reg8 bit No. CL ← 0						
		mem8,CL	0	0	0	1	0	0	1	0	mod	0	0	0	0	mem	3 to 5	(mem8) bit No. CL ← 0						
		reg16,CL	0	0	0	1	1	1	0	0	0	reg	3	reg16 bit No. CL ← 0										
		mem16,CL	0	0	0	1	1	1	0	0	0	mem	3 to 5	(mem16) bit No. CL ← 0										
		reg8,imm3	1	0	1	0	1	0	1	0	0	reg	4	reg8 bit No. imm3 ← 0										
		mem8,imm3	1	0	1	0	1	0	0	0	0	mem	4 to 6	(mem8) bit No. imm3 ← 0										
		reg16,imm4	1	0	1	1	0	1	1	0	0	reg	4	reg16 bit No. imm4 ← 0										
		mem16,imm4	1	0	1	1	0	1	1	0	0	mem	4 to 6	(mem16) bit No. imm4 ← 0										
	SET1	reg8,CL	0	1	0	0	1	1	0	0	reg	3	reg8 bit No. CL ← 1											
		mem8,CL	0	1	0	0	1	1	0	0	mem	3 to 5	(mem8) bit No. CL ← 1											
		reg16,CL	0	1	0	1	1	1	0	0	reg	3	reg16 bit No. CL ← 1											
		mem16,CL	0	1	0	1	1	1	0	0	mem	3 to 5	(mem16) bit No. CL ← 1											
		reg8,imm3	1	1	0	0	1	1	0	0	reg	4	reg8 bit No. imm3 ← 1											
		mem8,imm3	1	1	0	0	1	1	0	0	mem	4 to 6	(mem8) bit No. imm3 ← 1											
		reg16,imm4	1	1	0	1	1	1	0	0	reg	4	reg16 bit No. imm4 ← 1											
		mem16,imm4	1	1	0	1	1	1	0	0	mem	4 to 6	(mem16) bit No. imm4 ← 1											

Note 1st byte = 0FH

2nd byte Note 3rd byte Note

CLR1	CY	1	1	1	1	1	0	0	0	0	0	0	0	reg	1	CY ← 0						
	DIR	1	1	1	1	1	1	0	0	0	0	0	0	mem	1	DIR ← 0						
SET1	CY	1	1	1	1	1	0	0	1	0	0	1	0	reg	1	CY ← 1						
	DIR	1	1	1	1	1	0	1	0	1	0	1	0	mem	1	DIR ← 1						

Group	Mnemonic	Operand	Operation Code										Bytes	Operation	Flags										
			7	6	5	4	3	2	1	0	7	6			5	4	3	2	1	0	AC	CY	V	P	S
Shift	SHL	reg,1	1	1	0	1	0	0	0	W	1	1	1	0	0	reg	2	CY ← reg MSB, reg ← reg × 2 When reg MSB ≠ CY, V ← 1 When reg MSB = CY, V ← 0	U	x	x		x	x	
		mem,1	1	1	0	1	0	0	0	W	mod	1	0	0	mem	2 to 4	CY ← (mem) MSB, (mem) ← (mem) × 2 When (mem) MSB ≠ CY, V ← 1 When (mem) MSB = CY, V ← 0	U	x	x		x	x		
		reg,CL	1	1	0	1	0	0	1	W	1	1	1	0	0	reg	2	The following operations are repeated while temp ← CL and temp ≠ 0. CY ← reg MSB, reg ← reg × 2 temp ← temp - 1	U	x	x	U	x	x	
		mem,CL	1	1	0	1	0	0	1	W	mod	1	0	0	mem	2 to 4	The following operations are repeated while temp ← CL and temp ≠ 0. CY ← (mem) MSB, (mem) ← (mem) × 2 temp ← temp - 1	U	x	x	U	x	x		
		reg,imm8	1	1	0	0	0	0	0	W	1	1	1	0	0	reg	3	The following operations are repeated while temp ← imm8 and temp ≠ 0. CY ← reg MSB, reg ← reg × 2 temp ← temp - 1	U	x	x	U	x	x	
		mem,imm8	1	1	0	0	0	0	0	W	mod	1	0	0	mem	3 to 5	The following operations are repeated while temp ← imm8 and temp ≠ 0. CY ← (mem) MSB, (mem) ← (mem) × 2 temp ← temp - 1	U	x	x	U	x	x		



Group	Mnemonic	Operand	Operation Code										Bytes	Operation	Flags									
			7	6	5	4	3	2	1	0	7	6			5	4	3	2	1	0	AC	CY	V	P
Rotate	ROL	reg,1	1	1	0	1	0	0	0	W	1	1	0	0	0	reg	2	CY ← reg MSB, reg ← reg × 2 + CY reg MSB ≠ CY: V ← 1 reg MSB = CY: V ← 0	x		x			
		mem,1	1	1	0	1	0	0	0	W	mod 0 0 0 mem	2 to 4	CY ← (mem) MSB, (mem) ← (mem) × 2 + CY (mem) MSB ≠ CY: V ← 1 (mem) MSB = CY: V ← 0	x		x								
		reg,CL	1	1	0	1	0	0	1	W	1 1 0 0 0 reg	2	The following operations are repeated while temp ← CL and temp ≠ 0. CY ← reg MSB, reg ← reg × 2 + CY temp ← temp - 1	x					U					
		mem,CL	1	1	0	1	0	0	1	W	mod 0 0 0 mem	2 to 4	The following operations are repeated while temp ← CL and temp ≠ 0. CY ← (mem) MSB, (mem) ← (mem) × 2 + CY temp ← temp - 1	x					U					
	reg,imm8	1	1	0	0	0	0	W	1 1 0 0 0 reg	3	The following operations are repeated while temp ← imm8 and temp ≠ 0. CY ← reg MSB, reg ← reg × 2 + CY temp ← temp - 1	x					U							
	mem,imm8	1	1	0	0	0	0	W	mod 0 0 0 mem	3 to 5	The following operations are repeated while temp ← imm8 and temp ≠ 0. CY ← (mem) MSB, (mem) ← (mem) × 2 + CY temp ← temp - 1	x					U							
	ROR	reg,1	1	1	0	1	0	0	0	W	1 1 0 0 1 reg	2	CY ← reg LSB, reg ← reg ÷ 2 reg MSB ← CY reg MSB ≠ bit following reg MSB: V ← 1 reg MSB = bit following reg MSB: V ← 0	x		x								
		mem,1	1	1	0	1	0	0	0	W	mod 0 0 1 mem	2 to 4	CY ← (mem) LSB, (mem) ← (mem) ÷ 2 (mem) MSB ← CY (mem) MSB ≠ bit following (mem) MSB: V ← 1 (mem) MSB = bit following (mem) MSB: V ← 0	x		x								
reg,CL		1	1	0	1	0	0	1	W	1 1 0 0 1 reg	2	The following operations are repeated while temp ← CL and temp ≠ 0. CY ← reg LSB, reg ← reg ÷ 2 reg MSB ← CY temp ← temp - 1	x					U						
mem,CL		1	1	0	1	0	0	1	W	mod 0 0 1 mem	2 to 4	The following operations are repeated while temp ← CL and temp ≠ 0. CY ← (mem) LSB, (mem) ← (mem) ÷ 2 (mem) MSB ← CY temp ← temp - 1	x					U						
reg,imm8	1	1	0	0	0	0	W	1 1 0 0 1 reg	3	The following operations are repeated while temp ← imm8 and temp ≠ 0. CY ← reg LSB, reg ← reg ÷ 2 reg MSB ← CY temp ← temp - 1	x					U								
mem,imm8	1	1	0	0	0	0	W	mod 0 0 1 mem	3 to 5	The following operations are repeated while temp ← imm8 and temp ≠ 0. CY ← (mem) LSB, (mem) ← (mem) ÷ 2 (mem) MSB ← CY temp ← temp - 1	x					U								

Group	Mnemonic	Operand	Operation Code		Bytes	Operation	Flags					
			7 6 5 4 3 2 1 0	7 6 5 4 3 2 1 0			AC	CY	V	P	S	Z
Rotate	ROL	reg,1	1 1 0 1 0 0 0 W	1 1 0 1 0 reg	2	$tmpcy \leftarrow CY, CY \leftarrow reg\ MSB$ $reg \leftarrow reg \times 2 + tmpcy$ $reg\ MSB \neq CY: V \leftarrow 1$ $reg\ MSB = CY: V \leftarrow 0$	x	x				
		mem,1	1 1 0 1 0 0 0 W	mod 0 1 0 mem	2 to 4	$tmpcy \leftarrow CY, CY \leftarrow (mem)\ MSB$ $(mem) \leftarrow (mem) \times 2 + tmpcy$ $(mem)\ MSB \neq CY: V \leftarrow 1$ $(mem)\ MSB = CY: V \leftarrow 0$	x	x				
		reg,CL	1 1 0 1 0 0 1 W	1 1 0 1 0 reg	2	The following operations are repeated while $temp \leftarrow CL$ and $temp \neq 0$ . $tmpcy \leftarrow CY, CY \leftarrow reg\ MSB$ $reg \leftarrow reg \times 2 + tmpcy$ $temp \leftarrow temp - 1$	x		U			
		mem,CL	1 1 0 1 0 0 1 W	mod 0 1 0 mem	2 to 4	The following operations are repeated while $temp \leftarrow CL$ and $temp \neq 0$ . $tmpcy \leftarrow CY, CY \leftarrow (mem)\ MSB$ $(mem) \leftarrow (mem) \times 2 + tmpcy$ $temp \leftarrow temp - 1$	x		U			
		reg,imm8	1 1 0 0 0 0 0 W	1 1 0 1 0 reg	3	The following operations are repeated while $temp \leftarrow imm8$ and $temp \neq 0$ . $tmpcy \leftarrow CY, CY \leftarrow reg\ MSB$ $reg \leftarrow reg \times 2 + tmpcy$ $temp \leftarrow temp - 1$	x		U			
		mem,imm8	1 1 0 0 0 0 0 W	mod 0 1 0 mem	3 to 5	The following operations are repeated while $temp \leftarrow imm8$ and $temp \neq 0$ . $tmpcy \leftarrow CY, CY \leftarrow (mem)\ MSB$ $(mem) \leftarrow (mem) \times 2 + tmpcy$ $temp \leftarrow temp - 1$	x		U			

Group	Mnemonic	Operand	Operation Code										Bytes	Operation	Flags																			
			7	6	5	4	3	2	1	0	7	6			5	4	3	2	1	0	AC	CY	V	P	S	Z								
Rotate	RORC	reg,1	1	1	0	1	0	0	0	0	1	0	1	1	0	1	0	1	0	2	$tmpcy \leftarrow CY, CY \leftarrow reg\ LSB$ $reg \leftarrow reg + 2$ $reg\ MSB \leftarrow tmpcy$ $reg\ MSB \neq \text{bit following } reg\ MSB: V \leftarrow 1$ $reg\ MSB = \text{bit following } reg\ MSB: V \leftarrow 0$													
			1	1	0	1	0	0	0	0	1	0	1	1	0	1	0	1	0	2 to 4	$tmpcy \leftarrow CY, CY \leftarrow (mem)\ LSB$ $(mem) \leftarrow (mem) + 2$ $(mem)\ MSB \leftarrow tmpcy$ $(mem)\ MSB \neq \text{bit following } (mem)\ MSB: V \leftarrow 1$ $(mem)\ MSB = \text{bit following } (mem)\ MSB: V \leftarrow 0$													
		1	1	0	1	0	0	1	1	0	1	1	0	1	1	0	1	1	0	2	The following operations are repeated while $temp \leftarrow CL$ and $temp \neq 0$ . $tmpcy \leftarrow CY, CY \leftarrow reg\ LSB$ $reg \leftarrow reg + 2$ $reg\ MSB \leftarrow tmpcy$ $temp \leftarrow temp - 1$													
		1	1	0	1	0	0	1	1	0	1	1	0	1	1	0	1	1	0	2 to 4	The following operations are repeated while $temp \leftarrow CL$ and $temp \neq 0$ . $tmpcy \leftarrow CY, CY \leftarrow (mem)\ LSB$ $(mem) \leftarrow (mem) + 2$ $(mem)\ MSB \leftarrow tmpcy$ $temp \leftarrow temp - 1$													
		1	1	0	0	0	0	0	0	1	1	0	1	1	0	1	1	0	1	1	3	The following operations are repeated while $temp \leftarrow imm8$ and $temp \neq 0$ . $tmpcy \leftarrow CY, CY \leftarrow reg\ LSB$ $reg \leftarrow reg + 2$ $reg\ MSB \leftarrow tmpcy$ $temp \leftarrow temp - 1$												
		1	1	0	0	0	0	0	0	1	1	0	1	1	0	1	1	0	1	1	3 to 5	The following operations are repeated while $temp \leftarrow imm8$ and $temp \neq 0$ . $tmpcy \leftarrow CY, CY \leftarrow (mem)\ LSB$ $(mem) \leftarrow (mem) + 2$ $(mem)\ MSB \leftarrow tmpcy$ $temp \leftarrow temp - 1$												





Group	Mnemonic	Operand	Operation Code										Bytes	Operation	Flags								
			7	6	5	4	3	2	1	0	7	6			5	4	3	2	1	0	AC	CY	V
Stack manipulation	PUSH	mem16	1	1	1	1	1	1	1	1	1	1	0	mem	2 to 4	(SP - 1, SP - 2) ← (mem16) SP ← SP - 2							
		reg16	0	1	0	1	0	reg	1	1	1	1	0	mem	1	(SP - 1, SP - 2) ← reg16 SP ← SP - 2							
	sreg	0	0	0	sreg	1	1	0						1	(SP - 1, SP - 2) ← sreg SP ← SP - 2								
	PSW	1	0	0	1	1	0	0						1	(SP - 1, SP - 2) ← PSW SP ← SP - 2								
	R	0	1	1	0	0	0	0	0						1	Push registers on the stack							
	imm8	0	1	1	0	1	0	1	0						2	(SP - 1, SP - 2) ← imm8 sign extension SP ← SP - 2							
	imm16	0	1	1	0	1	0	0	0						3	(SP - 1, SP - 2) ← imm16 SP ← SP - 2							
	POP	mem16	1	0	0	0	1	1	1	1	mod	0	0	0	mem	2 to 4	(mem16) ← (SP + 1, SP) SP ← SP + 2						
		reg16	0	1	0	1	1	reg						1	reg16 ← (SP + 1, SP) SP ← SP + 2								
		sreg	0	0	0	sreg	1	1	1					1	sreg ← (SP + 1, SP) SP ← SP + 2								
PSW		1	0	0	1	1	0	1						1	PSW ← (SP + 1, SP) SP ← SP + 2								
PREPARE	R	0	1	1	0	0	0	0	1					1	Pop registers from the stack								
	imm16,imm8	1	1	0	0	1	0	0	0	1				4	Prepare New Stack Frame								
DISPOSE		1	1	0	0	1	0	0	1					1	Dispose of Stack Frame								
	near-label	1	1	1	0	1	0	0	1					3	PC ← PC + disp								
Branch	short-label	1	1	1	0	1	0	1	1					2	PC ← PC + ext-disp8								
	regptr16	1	1	1	1	1	1	1	1	1	1	1	0	0	reg	2	PC ← regptr16						
	memptr16	1	1	1	1	1	1	1	1	mod	1	0	0	mem	2 to 4	PC ← (memptr16)							
	far-label	1	1	1	0	1	0	1	0					5	PS ← seg PC ← offset								
	memptr32	1	1	1	1	1	1	1	1	mod	1	0	1	mem	2 to 4	PS ← (memptr32 + 2) PC ← (memptr32)							





Group	Mnemonic	Operand	Operation Code										Bytes	Operation	Flags																									
			7	6	5	4	3	2	1	0	7	6			5	4	3	2	1	0	AC	CY	V	P	S	Z														
CPU control	HALT		1	1	1	1	0	1	0	0																1	CPU Halt													
	STOP <sup>Note 2</sup>		0	0	0	0	1	1	1	1	1	0	1	0	0	1	1	1	1	0																				
	POLL		1	0	0	1	1	0	1	1																														
	DI		1	1	1	1	1	0	1	0																														
	EI		1	1	1	1	1	0	1	1																														
	BUSLOCK		1	1	1	1	0	0	0	0																														
	FPO1	fp-op		1	1	0	1	1	X	X	X		1	1	Y	Y	Y	Z	Z	Z	2	No Operation																		
	fp-op,mem		1	1	0	1	1	X	X	X	mod	Y	Y	Y	mem																									
FPO2	fp-op		0	1	1	0	0	1	1	X		1	1	Y	Y	Y	Z	Z	Z	2	No Operation																			
	fp-op,mem		0	1	1	0	0	1	1	X	mod	Y	Y	Y	mem																									
NOP			1	0	0	1	0	0	0	0																														
			0	0	1	sreg	1	1	0																															
			0	0	1	sreg	1	1	0																															

**Notes 1.** DS0.; DS1.; PS: and SS:

**2.** This instruction is newly added to the  $\mu$ PD70108/70116.

**3.** In the  $\mu$ PD70320, an interrupt is generated without executing these instructions.



## 2.4 Number of Clocks Table

### (1) Legend

The number of clocks, for memory operand, differs among addressing modes. So, use the following values for “EA” items shown in **Table 2-9 Number of Clocks**.

**Table 2-8. Number of Clocks for Each Memory Addressing**

mem \ mod	00		01		10	
		Clocks		Clocks		Clocks
000	BW + IX	3	BW + IX + disp8	3	BW + IX + disp16	4
001	BW + IY	3	BW + IY + disp8	3	BW + IY + disp16	4
010	BP + IX	3	BP + IX + disp8	3	BP + IX + disp16	4
011	BP + IY	3	BP + IY + disp8	3	BP + IY + disp16	4
100	IX	3	IX + disp8	3	IX + disp16	4
101	IY	3	IY + disp8	3	IY + disp16	4
110	Direct address	3	BP + disp8	3	BP + disp16	4
111	BW	3	BW + disp8	3	BW + disp16	4

“T” indicates the number of wait states. Use any number of waits starting at “0” (no wait).

(2) Number of clocks

Table 2-9. Number of Clocks (1/10)

Group	Mnemonic	Operands	Number of Clocks			
			Byte Processing		Word Processing	
			On-chip RAM Access Enable	On-chip RAM Access Disable	On-chip RAM Access Enable	On-chip RAM Access Disable
Data transfer	MOV	reg, reg'	2	2	2	2
		mem, reg	EA + 4 + T	EA + 2	EA + 6 + 2·T	EA + 2
		reg, mem	EA + 6 + T	EA + 6 + T	EA + 8 + 2·T	EA + 8 + 2·T
		mem, imm	EA + 5 + T	EA + 5 + T	EA + 5 + 2·T	EA + 5 + T
		reg, imm	5	5	6	6
		acc, dmem	9 + T	9 + T	11 + 2·T	11 + 2·T
		dmem, acc	7 + T	5	9 + 2·T	5
		sreg, reg16	—	—	4	4
		sreg, mem16	—	—	EA + 10 + 2·T	EA + 10 + 2·T
		reg16, sreg	—	—	3	3
		mem16, sreg	—	—	EA + 7 + 2·T	EA + 3
		DS0, reg16, mem32	—	—	EA + 19 + 4·T	EA + 19 + 4·T
		DS1, reg16, mem32	—	—	EA + 19 + 4·T	EA + 19 + 4·T
		AH, PSW	2	2	—	—
	PSW, AH	3	3	—	—	
	LDEA	reg16, mem16	—	—	EA + 2	EA + 2
	TRANS	src-table	10 + T	10 + T	—	—
	XCH	reg, reg'	3	3	3	3
		mem, reg/ reg, mem	EA + 10 + 2·T	EA + 8 + 2·T	EA + 14 + 2·T	EA + 10 + 2·T
		AW, reg16/ reg16, AW	—	—	4	4
MOVSPA		—	—	16	16	
MOVSPB	reg16	—	—	11	11	
Repeat prefix	REPC		2	2	2	2
	REPNC		2	2	2	2
	REP/REPE/ REPZ		2	2	2	2
	REPNE/ REPNZ		2	2	2	2
Primitive block transfer	MOVKB <sup>Note 1</sup> <sup>Note 2</sup>	dst-block,	20 + 2·T	16 + T	24 + 4·T	20 + 2·T
		src-block	16 + (16 + 2·T)·n	16 + (12 + T)·n	16 + (20 + 4·T)·n	16 + (12 + 2·T)·n
	CMPKB <sup>Note 1</sup> <sup>Note 2</sup>	dst-block,	23 + 2·T	19 + T	27 + 4·T	21 + 4·T
		src-block	16 + (21 + 2·T)·n	16 + (21 + 2·T)·n	16 + (25 + 4·T)·n	16 + (25 + 2·T)·n

Notes 1. Not repeated

2. Repeated, n: number of transfer times (n ≥ 1)

**Table 2-9. Number of Clocks (2/10)**

Group	Mnemonic	Operands	Number of Clocks			
			Byte Processing		Word Processing	
			On-chip RAM Access Enable	On-chip RAM Access Disable	On-chip RAM Access Enable	On-chip RAM Access Disable
Primitive block transfer	CMPM <small>Note 1</small> <small>Note 2</small>	dst-block	17 + T	17 + T	19 + 2·T	19 + 2·T
		src-block	16 + (15 + T)·n	16 + (15 + T)·n	16 + (17 + 2·T)·n	16 + (17 + 2·T)·n
	LDM <small>Note 1</small> <small>Note 2</small>	src-block	12 + T	12 + T	14 + 2·T	14 + 2·T
			16 + (10 + T)·n	16 + (10 + T)·n	16 + (12 + 2·T)·n	16 + (12 + 2·T)·n
	STM <small>Note 1</small> <small>Note 2</small>	dst-block	12 + T	10	14 + 2·T	10
			16 + (8 + T)·n	16 + (6 + T)·n	16 + (10 + 2·T)·n	16 + (6 + 2·T)·n
Bit field manipulation	INS	reg8, reg8'	63 to 155 (The processing differs among bit lengths.)			
		reg8, imm4	64 to 156 (The processing differs among bit lengths.)			
	EXT	reg8, reg8'	41 to 121 (The processing differs among bit lengths.)			
		reg8, imm4	42 to 122 (The processing differs among bit lengths.)			
I/O	IN <small>Note 3</small>	acc, imm8	14 + T	14 + T	16 + 2·T	16 + 2·T
		acc, DW	13 + T	13 + T	15 + 2·T	15 + 2·T
	OUT <small>Note 3</small>	imm8, acc	10 + T	10 + T	10 + 2·T	10 + 2·T
		DW, acc	9 + T	9 + T	9 + 2·T	9 + 2·T
Primitive I/O	INM <small>Note 3</small>	dst-block, DW	19 + 2·T	17 + 2·T	21 + 4·T	17 + 4·T
			18 + (13 + 2·T)·n	18 + (11 + 2·T)·n	18 + (15 + 4·T)·n	18 + (11 + 4·T)·n
	OUTM <small>Note 3</small>	DW, src-block	19 + 2·T	17 + 2·T	21 + 4·T	17 + 4·T
			18 + (13 + 2·T)·n	18 + (11 + 2·T)·n	18 + (15 + 4·T)·n	18 + (11 + 4·T)·n
Addition/subtraction	ADD	reg, reg'	2	2	2	2
		mem, reg	EA + 8 + 2·T	EA + 6 + T	EA + 12 + 4·T	EA + 8 + 2·T
		reg, mem	EA + 6 + T	EA + 6 + T	EA + 8 + 2·T	EA + 8 + 2·T
		reg, imm	5	5	6	6
		mem, imm	EA + 9 + 2·T	EA + 7 + 2·T	EA + 14 + 4·T	EA + 10 + 4·T
		acc, imm	5	5	6	6
	ADDC	reg, reg'	2	2	2	2
		mem, reg	EA + 8 + 2·T	EA + 6 + T	EA + 12 + 4·T	EA + 8 + 2·T
		reg, mem	EA + 6 + T	EA + 6 + T	EA + 8 + 2·T	EA + 8 + 2·T
		reg, imm	5	5	6	6
		mem, imm	EA + 9 + 2·T	EA + 7 + 2·T	EA + 14 + 4·T	EA + 10 + 4·T
		acc, imm	5	5	6	6

- Notes**
1. Not repeated
  2. Repeated, n: number of transfer times ( $n \geq 1$ )
  3. When  $\overline{\text{IBRK}} = 1$



**Table 2-9. Number of Clocks (3/10)**

Group	Mnemonic	Operands	Number of Clocks			
			Byte Processing		Word Processing	
			On-chip RAM Access Enable	On-chip RAM Access Disable	On-chip RAM Access Enable	On-chip RAM Access Disable
Addition/ subtraction	SUB	reg, reg'	2	2	2	2
		mem, reg	$EA + 8 + 2 \cdot T$	$EA + 6 + T$	$EA + 12 + 4 \cdot T$	$EA + 8 + 2 \cdot T$
		reg, mem	$EA + 6 + T$	$EA + 6 + T$	$EA + 8 + 2 \cdot T$	$EA + 8 + 2 \cdot T$
		reg, imm	5	5	6	6
		mem, imm	$EA + 9 + 2 \cdot T$	$EA + 7 + 2 \cdot T$	$EA + 14 + 4 \cdot T$	$EA + 10 + 4 \cdot T$
		acc, imm	5	5	6	6
	SUBC	reg, reg'	2	2	2	2
		mem, reg	$EA + 8 + 2 \cdot T$	$EA + 6 + T$	$EA + 12 + 4 \cdot T$	$EA + 8 + 2 \cdot T$
		reg, mem	$EA + 6 + T$	$EA + 6 + T$	$EA + 8 + 2 \cdot T$	$EA + 8 + 2 \cdot T$
		reg, imm	5	5	6	6
		mem, imm	$EA + 9 + 2 \cdot T$	$EA + 7 + 2 \cdot T$	$EA + 14 + 4 \cdot T$	$EA + 10 + 4 \cdot T$
		acc, imm	5	5	6	6
BCD operation	ADD4S <sup>Note</sup>		$22 + (27 + 3 \cdot T) \cdot n$	$22 + (25 + 3 \cdot T) \cdot n$	—	—
	SUB4S <sup>Note</sup>		$22 + (27 + 3 \cdot T) \cdot n$	$22 + (25 + 3 \cdot T) \cdot n$	—	—
	CMP4S <sup>Note</sup>		$22 + (23 + 3 \cdot T) \cdot n$	$22 + (23 + 3 \cdot T) \cdot n$	—	—
	ROL4	reg8	17	17	—	—
		mem8	$EA + 18 + 2 \cdot T$	$EA + 16 + 2 \cdot T$	—	—
	ROR4	reg8	21	21	—	—
		mem8	$EA + 24 + 2 \cdot T$	$EA + 22 + 2 \cdot T$	—	—
Increment/ decrement	INC	reg8	5	5	—	—
		mem8	$EA + 11 + 2 \cdot T$	$EA + 9 + 2 \cdot T$	$EA + 15 + 4 \cdot T$	$EA + 11 + 4 \cdot T$
		reg16	—	—	2	2
	DEC	reg8	5	5	—	—
		mem8	$EA + 11 + 2 \cdot T$	$EA + 9 + 2 \cdot T$	$EA + 15 + 4 \cdot T$	$EA + 11 + 4 \cdot T$
		reg16	—	—	2	2
Multiplica- tion	MULU	reg8	24	24	—	—
		mem8	$EA + 26 + T$	$EA + 26 + T$	—	—
		reg16	—	—	32	32
		mem16	—	—	$EA + 34 + 2 \cdot T$	$EA + 34 + 2 \cdot T$

**Note** n: 1/2 of the number of BCD digits

**Table 2-9. Number of Clocks (4/10)**

Group	Mnemonic	Operands	Number of Clocks			
			Byte Processing		Word Processing	
			On-chip RAM Access Enable	On-chip RAM Access Disable	On-chip RAM Access Enable	On-chip RAM Access Disable
Multiplication	MUL	reg8	31 to 40	31 to 40	—	—
		mem8	EA + 33 + T to EA + 42 + T	EA + 33 + T to EA + 42 + T	—	—
		reg16	—	—	39 to 48	39 to 48
		mem16	—	—	EA + 43 + 2·T to EA + 52 + 2·T	EA + 43 + 2·T to EA + 52 + 2·T
		reg16, (reg16'.) imm8	—	—	39 to 49	39 to 49
		reg16, mem16, imm8	—	—	EA + 43 + 2·T to EA + 53 + 2·T	EA + 43 + 2·T to EA + 53 + 2·T
		reg16, (reg16'.) imm16	—	—	40 to 50	40 to 50
		reg16, mem16, imm16	—	—	EA + 44 + 2·T to EA + 54 + 2·T	EA + 44 + 2·T to EA + 54 + 2·T
Unsigned division	DIVU	reg8	31	31	—	—
		mem8	EA + 33 + T	EA + 33 + T	—	—
		reg16	—	—	39	39
		mem16	—	—	EA + 43 + 2·T	EA + 43 + 2·T
Signed division	DIV	reg8	46 to 56	46 to 56	—	—
		mem8	EA + 48 + T to EA + 58 + T	EA + 48 + T to EA + 58 + T	—	—
		reg16	—	—	54 to 64	54 to 64
		mem16	—	—	EA + 58 + 2·T to EA + 68 + 2·T	EA + 58 + 2·T to EA + 68 + 2·T
BCD adjustment	ADJBA		17	17	—	—
	ADJ4A		9	9	—	—
	ADJBS		17	17	—	—
	ADJ4S		9	9	—	—
Data conversion	CVTBD		19	19	—	—
	CVTDB		20	20	—	—
	CVTBW		3	3	—	—
	CVTWL		—	—	8	8
Compare	CMP	reg, reg'	2	2	2	2
		mem, reg	EA + 6 + T	EA + 6 + T	EA + 8 + 2·T	EA + 8 + 2·T
		reg, mem	EA + 6 + T	EA + 6 + T	EA + 8 + 2·T	EA + 8 + 2·T
		reg, imm	5	5	6	6
		mem, imm	EA + 7 + T	EA + 7 + T	EA + 10 + 2·T	EA + 10 + 2·T
		acc, imm	5	5	6	6

**Table 2-9. Number of Clocks (5/10)**

Group	Mnemonic	Operands	Number of Clocks				
			Byte Processing		Word Processing		
			On-chip RAM Access Enable	On-chip RAM Access Disable	On-chip RAM Access Enable	On-chip RAM Access Disable	
Complement operation	NOT	reg	5	5	5	5	
		mem	EA + 11 + 2·T	EA + 9 + T	EA + 15 + 4·T	EA + 11 + 2·T	
	NEG	reg	5	5	5	5	
		mem	EA + 11 + 2·T	EA + 9 + T	EA + 15 + 4·T	EA + 11 + 2·T	
Logical operation	TEST	reg, reg'	4	4	4	4	
		mem, reg/ reg, mem	EA + 8 + T	EA + 8 + T	EA + 10 + 2·T	EA + 10 + 2·T	
		reg, imm	7	7	8	8	
		mem, imm	EA + 11 + T	EA + 11 + T	EA + 11 + 2·T	EA + 11 + 2·T	
		acc, imm	5	5	6	6	
	AND	reg, reg'	2	2	2	2	
		mem, reg	EA + 8 + 2·T	EA + 6 + T	EA + 12 + 4·T	EA + 8 + 2·T	
		reg, mem	EA + 6 + T	EA + 6 + T	EA + 8 + 2·T	EA + 8 + 2·T	
		reg, imm	5	5	6	6	
		mem, imm	EA + 9 + T	EA + 7 + T	EA + 14 + 4·T	EA + 10 + 4·T	
		acc, imm	5	5	6	6	
	OR	reg, reg'	2	2	2	2	
		mem, reg	EA + 8 + 2·T	EA + 6 + T	EA + 12 + 4·T	EA + 8 + 2·T	
		reg, mem	EA + 6 + T	EA + 6 + T	EA + 8 + 2·T	EA + 8 + 2·T	
		reg, imm	5	5	6	6	
		mem, imm	EA + 9 + T	EA + 7 + T	EA + 14 + 4·T	EA + 10 + 4·T	
	XOR	reg, reg'	2	2	2	2	
		mem, reg	EA + 8 + 2·T	EA + 6 + T	EA + 12 + 4·T	EA + 8 + 2·T	
		reg, mem	EA + 6 + T	EA + 6 + T	EA + 8 + 2·T	EA + 8 + 2·T	
		reg, imm	5	5	6	6	
		mem, imm	EA + 9 + T	EA + 7 + T	EA + 14 + 4·T	EA + 10 + 4·T	
	Bit manipulation	TEST1	reg8, CL	7	7	—	—
			mem8, CL	EA + 11 + T	EA + 11 + T	—	—
			reg16, CL	—	—	7	7
mem16, CL			—	—	EA + 13 + 2·T	EA + 13 + 2·T	
reg8, imm3			6	6	—	—	
mem8, imm3			EA + 8 + T	EA + 8 + T	—	—	
reg16, imm4			—	—	6	6	
mem16, imm4			—	—	EA + 10 + 2·T	EA + 10 + 2·T	
NOT1		reg8, CL	7	7	—	—	
		mem8, CL	EA + 13 + 2·T	EA + 11 + T	—	—	
		reg16, CL	—	—	7	7	
		mem16, CL	—	—	—	—	

**Table 2-9. Number of Clocks (6/10)**

Group	Mnemonic	Operands	Number of Clocks				
			Byte Processing		Word Processing		
			On-chip RAM Access Enable	On-chip RAM Access Disable	On-chip RAM Access Enable	On-chip RAM Access Disable	
Bit manipulation	NOT1	mem16, CL	—	—	EA + 17 + 4·T	EA + 13 + 2·T	
		reg8, imm3	6	6	—	—	
		mem8, imm3	EA + 10 + 2·T	EA + 8 + T	—	—	
		reg16, imm4	—	—	6	6	
		mem16, imm4	—	—	EA + 14 + 4·T	EA + 10 + 2·T	
	NOT1	CY	2	2	2	2	
Bit manipulation	CLR1	reg8, CL	8	8	—	—	
		mem8, CL	EA + 14 + 2·T	EA + 12 + T	—	—	
		reg16, CL	—	—	8	8	
		mem16, CL	—	—	EA + 18 + 4·T	EA + 14 + 2·T	
		reg8, imm3	7	7	—	—	
		mem8, imm3	EA + 11 + 2·T	EA + 9 + T	—	—	
		reg16, imm4	—	—	7	7	
		mem16, imm4	—	—	EA + 15 + 4·T	EA + 10 + 2·T	
	SET1	reg8, CL	7	7	—	—	
		mem8, CL	EA + 13 + 2·T	EA + 11 + T	—	—	
		reg16, CL	—	—	7	7	
		mem16, CL	—	—	EA + 17 + 4·T	EA + 13 + 2·T	
		reg8, imm3	6	6	—	—	
		mem8, imm3	EA + 10 + 2·T	EA + 8 + T	—	—	
		reg16, imm4	—	—	6	6	
		mem16, imm4	—	—	EA + 14 + 4·T	EA + 10 + 2·T	
	CLR1	CY	2	2	2	2	
		DIR	2	2	2	2	
	SET1	CY	2	2	2	2	
		DIR	2	2	2	2	
	Shift	SHL	reg,1	8	8	8	8
			mem, 1	EA + 14 + 2·T	EA + 12 + T	EA + 18 + 4·T	EA + 14 + 2·T
			reg, CL	11 + 2·n	11 + 2·n	11 + 2·n	11 + 2·n
			mem, CL	EA + 17 + 2·T + 2·n	EA + 15 + T + 2·n	EA + 21 + 4·T + 2·n	EA + 17 + 2·T + 2·n
reg, imm8			9 + 2·n	9 + 2·n	9 + 2·n	9 + 2·n	
mem, imm8			EA + 13 + 2·T + 2·n	EA + 11 + T + 2·n	EA + 17 + 4·T + 2·n	EA + 13 + 2·T + 2·n	
SHR		reg, 1	8	8	8	8	
		mem, 1	EA + 14 + 2·T	EA + 12 + T	EA + 18 + 4·T	EA + 14 + 2·T	

**Note** n: Shift count

**Table 2-9. Number of Clocks (7/10)**

Group	Mnemonic	Operands	Number of Clocks				
			Byte Processing		Word Processing		
			On-chip RAM Access Enable	On-chip RAM Access Disable	On-chip RAM Access Enable	On-chip RAM Access Disable	
Shift	SHR	Note { reg, CL mem, CL reg, imm8 mem, imm8	reg, CL	11 + 2·n	11 + 2·n	11 + 2·n	11 + 2·n
			mem, CL	EA + 17 + 2·T + 2·n	EA + 15 + T + 2·n	EA + 21 + 4·T + 2·n	EA + 17 + 2·T + 2·n
			reg, imm8	9 + 2·n	9 + 2·n	9 + 2·n	9 + 2·n
			mem, imm8	EA + 13 + 2·T + 2·n	EA + 11 + T + 2·n	EA + 17 + 4·T + 2·n	EA + 13 + 2·T + 2·n
	SHRA	reg,1 mem, 1	reg,1	8	8	8	8
			mem, 1	EA + 14 + 2·T	EA + 12 + T	EA + 18 + 4·T	EA + 14 + 2·T
		Note { reg, CL mem, CL reg, imm8 mem, imm8	reg, CL	11 + 2·n	11 + 2·n	11 + 2·n	11 + 2·n
			mem, CL	EA + 17 + 2·T + 2·n	EA + 15 + T + 2·n	EA + 21 + 4·T + 2·n	EA + 17 + 2·T + 2·n
			reg, imm8	9 + 2·n	9 + 2·n	9 + 2·n	9 + 2·n
			mem, imm8	EA + 13 + 2·T + 2·n	EA + 11 + T + 2·n	EA + 17 + 4·T + 2·n	EA + 13 + 2·T + 2·n
Rotate	ROL	Note { reg,1 mem, 1 reg, CL mem, CL reg, imm8 mem, imm8	reg,1	8	8	8	8
			mem, 1	EA + 14 + 2·T	EA + 12 + T	EA + 18 + 4·T	EA + 14 + 2·T
			reg, CL	11 + 2·n	11 + 2·n	11 + 2·n	11 + 2·n
			mem, CL	EA + 17 + 2·T + 2·n	EA + 15 + T + 2·n	EA + 21 + 4·T + 2·n	EA + 17 + 2·T + 2·n
			reg, imm8	9 + 2·n	9 + 2·n	9 + 2·n	9 + 2·n
			mem, imm8	EA + 13 + 2·T + 2·n	EA + 11 + T + 2·n	EA + 17 + 4·T + 2·n	EA + 13 + 2·T + 2·n
	ROR	Note { reg,1 mem, 1 reg, CL mem, CL reg, imm8 mem, imm8	reg,1	8	8	8	8
			mem, 1	EA + 14 + 2·T	EA + 12 + T	EA + 18 + 4·T	EA + 14 + 2·T
			reg, CL	11 + 2·n	11 + 2·n	11 + 2·n	11 + 2·n
			mem, CL	EA + 17 + 2·T + 2·n	EA + 15 + T + 2·n	EA + 21 + 4·T + 2·n	EA + 17 + 2·T + 2·n
			reg, imm8	9 + 2·n	9 + 2·n	9 + 2·n	9 + 2·n
			mem, imm8	EA + 13 + 2·T + 2·n	EA + 11 + T + 2·n	EA + 17 + 4·T + 2·n	EA + 13 + 2·T + 2·n
	ROLC	Note { reg,1 mem, 1 reg, CL mem, CL reg, imm8 mem, imm8	reg,1	8	8	8	8
			mem, 1	EA + 14 + 2·T	EA + 12 + T	EA + 18 + 4·T	EA + 14 + 2·T
			reg, CL	11 + 2·n	11 + 2·n	11 + 2·n	11 + 2·n
			mem, CL	EA + 17 + 2·T + 2·n	EA + 15 + T + 2·n	EA + 21 + 4·T + 2·n	EA + 17 + 2·T + 2·n
			reg, imm8	9 + 2·n	9 + 2·n	9 + 2·n	9 + 2·n
			mem, imm8	EA + 13 + 2·T + 2·n	EA + 11 + T + 2·n	EA + 17 + 4·T + 2·n	EA + 13 + 2·T + 2·n
	RORC	reg,1 mem, 1	reg,1	8	8	8	8
			mem, 1	EA + 14 + 2·T	EA + 12 + T	EA + 18 + 4·T	EA + 14 + 2·T

**Note** n: Shift count

**Table 2-9. Number of Clocks (8/10)**

Group	Mnemonic	Operands	Number of Clocks				
			Byte Processing		Word Processing		
			On-chip RAM Access Enable	On-chip RAM Access Disable	On-chip RAM Access Enable	On-chip RAM Access Disable	
Rotate	RORC	Note 1	reg, CL	$11 + 2 \cdot n$	$11 + 2 \cdot n$	$11 + 2 \cdot n$	$11 + 2 \cdot n$
			mem, CL	$EA + 17 + 2 \cdot T + 2 \cdot n$	$EA + 15 + T + 2 \cdot n$	$EA + 21 + 4 \cdot T + 2 \cdot n$	$EA + 17 + 2 \cdot T + 2 \cdot n$
			reg, imm8	$9 + 2 \cdot n$	$9 + 2 \cdot n$	$9 + 2 \cdot n$	$9 + 2 \cdot n$
			mem, imm8	$EA + 13 + 2 \cdot T + 2 \cdot n$	$EA + 11 + T + 2 \cdot n$	$EA + 17 + 4 \cdot T + 2 \cdot n$	$EA + 13 + 2 \cdot T + 2 \cdot n$
Subroutine control	CALL	near-proc	—	—	$22 + 2 \cdot T$	$18 + 2 \cdot T$	
		regptr16	—	—	$22 + 2 \cdot T$	$18 + 2 \cdot T$	
		memptr16	—	—	$EA + 26 + 4 \cdot T$	$EA + 24 + 4 \cdot T$	
		far-proc	—	—	$38 + 4 \cdot T$	$34 + 4 \cdot T$	
		memptr32	—	—	$EA + 36 + 8 \cdot T$	$EA + 24 + 8 \cdot T$	
	RET		—	—	$20 + 2 \cdot T$	$20 + 2 \cdot T$	
		pop-value	—	—	$20 + 2 \cdot T$	$20 + 2 \cdot T$	
			—	—	$29 + 4 \cdot T$	$29 + 4 \cdot T$	
		pop-value	—	—	$30 + 4 \cdot T$	$30 + 4 \cdot T$	
Stack manipulation	PUSH	mem16	—	—	$EA + 18 + 4 \cdot T$	$EA + 14 + 4 \cdot T$	
		reg16	—	—	$10 + 2 \cdot T$	6	
		sreg	—	—	$11 + 2 \cdot T$	7	
		PSW	—	—	$10 + 2 \cdot T$	6	
		R	—	—	$82 + 16 \cdot T$	50	
		imm8	—	—	$13 + 2 \cdot T$	9	
		imm16	—	—	$14 + 2 \cdot T$	10	
	POP	mem16	—	—	$EA + 16 + 4 \cdot T$	$EA + 12 + 2 \cdot T$	
		reg16	—	—	$12 + 2 \cdot T$	$12 + 2 \cdot T$	
		sreg	—	—	$13 + 2 \cdot T$	$13 + 2 \cdot T$	
		PSW	—	—	$14 + 2 \cdot T$	$14 + 2 \cdot T$	
		R	—	—	$82 + 16 \cdot T$	58	
	PREPARE	imm16, imm8	When imm8 = 0, $27 + 2 \cdot T$ When imm8 = 1, $39 + 4 \cdot T$ When imm8 = n, $n > 1$ , $46 + 19(n - 1) + 4 \cdot T$				
			Note 2				
	DISPOSE		—	—	$12 + 2 \cdot T$	$12 + 2 \cdot T$	

**Notes** 1. n: Shift count

2. Depth of procedure block (lexical level)

**Table 2-9. Number of Clocks (9/10)**

Group	Mnemonic	Operands	Number of Clocks			
			Byte Processing		Word Processing	
			On-chip RAM Access Enable	On-chip RAM Access Disable	On-chip RAM Access Enable	On-chip RAM Access Disable
Branch	BR	near-label	—	—	12	12
		short-label	—	—	12	12
		regptr16	—	—	13	13
		memptr16	—	—	EA + 17 + 2·T	EA + 17 + 2·T
		far-label	—	—	15	15
		memptr32	—	—	EA + 25 + 4·T	EA + 25 + 4·T
Conditional branch <sup>Note</sup>	BV	short-label	—	—	15/8	15/8
	BNV	short-label	—	—	15/8	15/8
	BC/BL	short-label	—	—	15/8	15/8
	BNC/BNL	short-label	—	—	15/8	15/8
	BE/BZ	short-label	—	—	15/8	15/8
	BNE/BNZ	short-label	—	—	15/8	15/8
	BNH	short-label	—	—	15/8	15/8
	BH	short-label	—	—	15/8	15/8
	BN	short-label	—	—	15/8	15/8
	BP	short-label	—	—	15/8	15/8
	BPE	short-label	—	—	15/8	15/8
	BPO	short-label	—	—	15/8	15/8
	BLT	short-label	—	—	15/8	15/8
	BGE	short-label	—	—	15/8	15/8
	BLE	short-label	—	—	15/8	15/8
	BGT	short-label	—	—	15/8	15/8
	DBNZNE	short-label	—	—	17/8	17/8
	DBNZE	short-label	—	—	17/8	17/8
	DBNZ	short-label	—	—	17/8	17/8
	BCWZ	short-label	—	—	15/8	15/8
BTCLR	sfr, imm3, short-label	29/21	29/21	—	—	
Interrupt	BRK	3	—	—	55 + 10·T	43 + 10·T
		imm8 (≠ 3)	—	—	56 + 10·T	44 + 10·T
	BRKV		—	—	55 + 10·T	43 + 10·T
	RETI		—	—	45 + 6·T	37 + 2·T
	RETRBI		—	—	12	12
	FINT		2	2	2	2
	CHKIND	reg16, mem32	—	—	EA + 26 + 4·T	EA + 26 + 4·T

**Note** In the number of clocks, the value on the left side of / indicates the number of clocks when the condition is true, and the value on the right side indicates the number of clocks when the condition is false.

**Table 2-9. Number of Clocks (10/10)**

Group	Mnemonic	Operands	Number of Clocks				
			Byte Processing		Word Processing		
			On-chip RAM Access Enable	On-chip RAM Access Disable	On-chip RAM Access Enable	On-chip RAM Access Disable	
Register bank switch	BRKCS	reg16	—	—	15	15	
	TSKSW	reg16	—	—	20	20	
CPU control	HALT		—	—	—	—	
	STOP		—	—	—	—	
	POLL		—	—	—	—	
	DI		4	4	4	4	
	EI		12	12	12	12	
	BUSLOCK		2	2	2	2	
	FPO1	fp-op		—	—	60 + 10·T	48 + 10·T
		fp-op, mem		—	—	60 + 10·T	48 + 10·T
	FPO2	fp-op		—	—	60 + 10·T	48 + 10·T
		fp-op, mem		—	—	60 + 10·T	48 + 10·T
NOP		4	4	4	4		
Segment override prefix (DS0:, DS1:, PS: and SS:)			2	2	2	2	



★ **3. ELECTRICAL SPECIFICATIONS**

**ABSOLUTE MAXIMUM RATINGS (T<sub>A</sub> = 25°C)**

Parameter	Symbol	Test Conditions	Rating	Unit
Supply Voltage	V <sub>DD</sub>		-0.5 to +7.0	V
	V <sub>TH</sub>		-0.5 to V <sub>DD</sub> + 0.5	V
Input Voltage	V <sub>I</sub>		-0.5 to V <sub>DD</sub> + 0.5	V
Output Voltage	V <sub>O</sub>		-0.5 to V <sub>DD</sub> + 0.5	V
Output Current Low	I <sub>OL</sub>	Each output pin	4.0	mA
		Total	50	mA
Output Current High	I <sub>OH</sub>	Each output pin	-2.0	mA
		Total	-20	mA
Operating Ambient Temperature	T <sub>A</sub>		-10 to +70	°C
Storage Temperature	T <sub>stg</sub>		-65 to +150	°C

- Cautions**
1. Do not make direct connections of the output (or input/output) pins of the IC product with each other, and also avoid direct connections to V<sub>DD</sub>, V<sub>CC</sub> or GND. However, the open drain pins or the open collector pins can be directly connected with each other. For the external circuit designed with the timing specifications so that any collision of the outputs from the pins subject to high-impedance state may be prevented, direct connection can be also made.
  2. Product quality may suffer if the absolute maximum ratings are exceeded for even a single parameter, or even momentarily. In other words, the absolute maximum ratings are rated values at which the product is on the verge of suffering physical damage, and therefore the product must be used under conditions which ensure that the absolute maximum ratings are not exceeded. The normal operation and reliability of the product can be only assured with the specifications and the conditions indicated as the DC and AC characteristics.

## OSCILLATOR CHARACTERISTICS

$\mu$ PD70325-8 ( $T_A = -10$  to  $+70^\circ\text{C}$ ,  $V_{DD} = +5.0\text{ V} \pm 10\%$ ,  $V_{SS} = 0\text{ V}$ ,  $0\text{ V} \leq V_{TH} \leq V_{DD} + 0.1\text{ V}$ )

$\mu$ PD70325-10 ( $T_A = -10$  to  $+70^\circ\text{C}$ ,  $V_{DD} = +5.0\text{ V} \pm 5\%$ ,  $V_{SS} = 0\text{ V}$ ,  $0\text{ V} \leq V_{TH} \leq V_{DD} + 0.1\text{ V}$ )

Resonator	Recommended Circuit	Parameter	$\mu$ PD70325-8		$\mu$ PD70325-10		Unit
			MIN.	MAX.	MIN.	MAX.	
Ceramic or Crystal Resonator		Oscillation frequency ( $f_{xx}$ )	4	16	4	20	MHz
External Clock	<p>①</p> <p>HCMOS Inverter</p>	X1 input frequency ( $f_x$ )	4	16	4	20	MHz
	<p>or</p> <p>②</p> <p>HCMOS Inverter</p> <p>Open</p>	X1 input rise/fall time ( $t_{XR}$ , $t_{XF}$ )	0	20	0	15	ns
			X1 input high-/low-level width ( $t_{WXH}$ , $t_{WXL}$ )	20		16	

- Cautions**
1. Mount the oscillation circuit as close to pins X1 and X2 as possible.
  2. Do not route other signal lines through the area within the dotted line.

## RECOMMENDED OSCILLATOR CONSTANT

- (1) The following ceramic resonator and external capacity are recommended.

Manufacturer	Part Number	Recommended Constants	
		C1 [pF]	C2 [pF]
Murata Mfg. Co., Ltd.	CSA16.00MX040	30	30
	CSA20.00MX040	10	10
TDK	FCR16.0M2G	30	30

- (2) The following crystal resonator and external capacity are recommended.

Manufacturer	Part Number	Recommended Constants	
		C1 [pF]	C2 [pF]
Kinseki Co., Ltd.	HC-49/U(KR-100)	22	22
	HC-49/U(KR-160)	22	22
	HC-49/U(KR-200)	22	22

**Remark** For more details on the characteristics of the resonators, please contact the manufacturer.

**CAPACITANCE (T<sub>A</sub> = 25°C, V<sub>DD</sub> = 0 V)**

Parameter	Symbol	Test Conditions	MIN.	TYP.	MAX.	Unit
Input Capacitance	C <sub>i</sub>	f <sub>c</sub> = 1 MHz			10	pF
Output Capacitance	C <sub>o</sub>	Unmeasured pins returned to 0 V.			20	pF
Input/output Capacitance	C <sub>io</sub>				20	pF

**DC CHARACTERISTICS**

**μPD70325-8 (T<sub>A</sub> = -10 to +70°C, V<sub>DD</sub> = +5.0 V ±10%)**

**μPD70325-10 (T<sub>A</sub> = -10 to +70°C, V<sub>DD</sub> = +5.0 V ±5%)**

Parameter	Symbol	Test Conditions	MIN.	TYP.	MAX.	Unit
Input Voltage Low	V <sub>IL</sub>		0		0.8	V
Input Voltage High	V <sub>IH1</sub>	Except $\overline{\text{RESET}}$ , P10/NMI, X1, X2	2.2		V <sub>DD</sub>	V
	V <sub>IH2</sub>	$\overline{\text{RESET}}$ , P10/NMI, X1, X2	0.8V <sub>DD</sub>		V <sub>DD</sub>	V
Output Voltage Low	V <sub>OL</sub>	I <sub>OL</sub> = 1.6 mA			0.45	V
Output Voltage High	V <sub>OH</sub>	I <sub>OH</sub> = -0.4 mA	V <sub>DD</sub> - 1.0			V
Input Current	I <sub>i</sub>	$\overline{\text{EA}}$ , P10/NMI; 0 ≤ V <sub>i</sub> ≤ V <sub>DD</sub>			±20	μA
Input Leakage Current	I <sub>li</sub>	Except $\overline{\text{EA}}$ , P10/NMI; 0 ≤ V <sub>i</sub> ≤ V <sub>DD</sub>			±10	μA
Output Leakage Current	I <sub>lo</sub>	0 ≤ V <sub>o</sub> ≤ V <sub>DD</sub>			±10	μA
V <sub>TH</sub> Current	I <sub>TH</sub>	0 V ≤ V <sub>TH</sub> ≤ V <sub>DD</sub>		0.5	1.0	mA
V <sub>DD</sub> Supply Current	I <sub>DD1</sub>	Operating mode	μPD70325-8	65	120	mA
			μPD70325-10	95	130	mA
	I <sub>DD2</sub>	HALT mode	μPD70325-8	25	50	mA
			μPD70325-10	30	55	mA
	I <sub>DD3</sub>	STOP mode		10	30	μA

**AC CHARACTERISTICS**

**(1) μPD70325-8 (T<sub>A</sub> = -10 to +70°C, V<sub>DD</sub> = +5.0 V ±10%)**

Parameter	Symbol	Test Conditions	MIN.	MAX.	Unit
X1 Input Cycle Time	t <sub>CYX</sub>		62	250	ns
X1 Input High-/Low-Level Width	t <sub>WXH</sub> , t <sub>WXL</sub>		20		ns
X1 Input Rise/Fall Time	t <sub>XR</sub> , t <sub>XF</sub>			20	ns
CLKOUT Output Cycle Time	t <sub>CYK</sub>	f <sub>x</sub> /2, T = t <sub>CYK</sub>	125	2000	ns
CLKOUT Output High-/Low-Level Width	t <sub>WKH</sub> , t <sub>WKL</sub>		0.5T - 15		ns
CLKOUT Output Rise/Fall Time	t <sub>KR</sub> , t <sub>KF</sub>			15	ns
Input Rise/Fall Time	t <sub>IR</sub> , t <sub>IF</sub>	Except $\overline{\text{RESET}}$ , NMI, X1 and X2		20	ns
	t <sub>IRS</sub> , t <sub>IFS</sub>	$\overline{\text{RESET}}$ , NMI		30	ns
Output Rise/Fall Time	t <sub>OR</sub> , t <sub>OF</sub>	Except CLKOUT		20	ns

Parameter	Symbol	Test Conditions	MIN.	MAX.	Unit
Address Delay Time from CLKOUT	t <sub>DKA</sub>		15	90	ns
Data Input Delay Time from Address	t <sub>DADR</sub>			(n + 1.5)T – 70	ns
Data Delay Time from $\overline{\text{MREQ}} \downarrow$	t <sub>DMRD</sub>			(n + 1)T – 60	ns
Data Delay Time from $\overline{\text{MSTB}} \downarrow$	t <sub>DMSD</sub>			(n + 0.5)T – 60	ns
$\overline{\text{MSTB}} \downarrow$ Delay Time from $\overline{\text{MREQ}} \downarrow$	t <sub>DMRMS</sub>		0.5T – 35	0.5T + 35	ns
$\overline{\text{MREQ}}$ Low-Level Width	t <sub>WMRL</sub>		(n + 1)T – 30	(n + 1)T + 30	ns
Address Hold Time (from $\overline{\text{MREQ}} \uparrow$ )	t <sub>HMA</sub>		0.5T – 30		ns
Data Input Hold Time (from $\overline{\text{MREQ}} \uparrow$ )	t <sub>HMDR</sub>		0		ns
Control Signal Recovery Time	t <sub>RV</sub>		T – 25		ns
Data Output Delay Time from Address	t <sub>DADW</sub>		0.5T – 35	0.5T + 50	ns
Address Setup Time (to $\overline{\text{MREQ}} \downarrow$ )	t <sub>DAMR</sub>		0.5T – 30		ns
Address Setup Time (to $\overline{\text{MSTB}} \downarrow$ )	t <sub>DAMS</sub>		T – 30		ns
$\overline{\text{MSTB}}$ Low-Level Width	t <sub>WMSL</sub>		(n + 0.5)T – 30	(n + 0.5)T + 30	ns
Data Output Setup Time (to $\overline{\text{MSTB}} \uparrow$ )	t <sub>SDM</sub>		(n + 1)T – 50		ns
Data Output Hold Time (from $\overline{\text{MSTB}} \uparrow$ )	t <sub>HMDW</sub>		0.5T – 30		ns
Address Setup Time (to $\overline{\text{IOSTB}} \downarrow$ )	t <sub>DAIS</sub>		0.5T – 30		ns
Data Delay Time from $\overline{\text{IOSTB}} \downarrow$	t <sub>DISD</sub>			(n + 1)T – 60	ns
$\overline{\text{IOSTB}}$ Low-Level Width	t <sub>WISL</sub>		(n + 1)T – 30		ns
Address Hold Time (from $\overline{\text{IOSTB}} \uparrow$ )	t <sub>HISA</sub>		0.5T – 30		ns
Data Input Hold Time (from $\overline{\text{IOREQ}} \uparrow$ )	t <sub>HISDR</sub>		0		ns
Data Output Setup Time (to $\overline{\text{IOSTB}} \uparrow$ )	t <sub>SDIS</sub>		(n + 1)T – 50		ns
Data Output Hold Time (from $\overline{\text{IOSTB}} \uparrow$ )	t <sub>HISDW</sub>		0.5T – 30		ns
$\overline{\text{DMARQ}}$ Setup Time (to $\overline{\text{MREQ}} \downarrow$ )	t <sub>SDADQ</sub>	Demand release mode, n ≥ 2		(n – 1)T – 50	ns
$\overline{\text{DMARQ}}$ Hold Time (from $\overline{\text{DMAAK}} \downarrow$ )	t <sub>HDADQ</sub>	Demand release mode	0		ns
$\overline{\text{DMAAK}}$ Output Low-Level Width	t <sub>WDMRL</sub>	Read operation	(n + 1.5)T – 30		ns
$\overline{\text{TC}} \downarrow$ Delay Time from $\overline{\text{DMAAK}} \downarrow$	t <sub>DDATC</sub>			0.5T + 50	ns
$\overline{\text{TC}}$ Low-Level Width	t <sub>WTCL</sub>		(n + 2)T – 30		ns
$\overline{\text{DMAAK}}$ Output Low-Level Width	t <sub>WDMWL</sub>	Write operation	(n + 1)T – 30		ns
Address Setup Time (to $\overline{\text{REFRQ}} \downarrow$ )	t <sub>DARF</sub>		0.5T – 30		ns
$\overline{\text{REFRQ}}$ Low-Level Width	t <sub>WRFL</sub>		(n + 1)T – 30		ns
Address Hold Time (from $\overline{\text{REFRQ}} \uparrow$ )	t <sub>HRFA</sub>		0.5T – 30		ns
$\overline{\text{RESET}}$ Low-Level Width	t <sub>WRSL1</sub>	STOP mode release/ power-ON reset	30		ms
	t <sub>WRSL2</sub>	System reset	5		μs
READY Setup Time (to $\overline{\text{MREQ}} \downarrow$ , $\overline{\text{IOSTB}} \downarrow$ )	t <sub>SCRY0</sub>	n ≥ 2		T – 100	ns
	t <sub>SCRY</sub>	n ≥ 3		(n – 1)T – 100	ns

**Remark** n indicates the number of wait states. No wait is “n = 0”.

Parameter	Symbol	Test Conditions	MIN.	MAX.	Unit
READY Hold Time (from $\overline{\text{MREQ}} \downarrow$ , $\overline{\text{IOSTB}} \downarrow$ )	t <sub>HCRY0</sub>	n = 2	T		ns
	t <sub>HCRY</sub>	n ≥ 3	(n - 1)T		ns
	t <sub>HCRY1</sub>	n ≥ 3	(n - 2)T		ns
HLD $\overline{\text{RQ}}$ Setup Time (to CLKOUT ↑)	t <sub>SHQK</sub>		30		ns
$\overline{\text{HLDAK}} \downarrow$ Delay Time from CLKOUT ↑	t <sub>DKHA</sub>		15	80	ns
$\overline{\text{HLDAK}} \downarrow$ Delay Time from Bus Float	t <sub>CFHA</sub>		T - 50		ns
Bus Output Delay Time from $\overline{\text{HLDAK}} \uparrow$	t <sub>DHAC</sub>		T - 50		ns
$\overline{\text{HLDAK}} \uparrow$ Delay Time from HLD $\overline{\text{RQ}} \downarrow$	t <sub>DHQHA</sub>			3T + 160	ns
Bus Output Delay Time from HLD $\overline{\text{RQ}} \downarrow$	t <sub>DHQC</sub>		3T + 30		ns
HLD $\overline{\text{RQ}}$ Low-Level Width	t <sub>WHQL</sub>		1.5T		ns
$\overline{\text{HLDAK}}$ Low-Level Width	t <sub>WHAL</sub>		T		ns
INT, DMARQ Setup Time (to CLKOUT ↑)	t <sub>SIQK</sub>		30		ns
INT, DMARQ High-/Low-Level Width	t <sub>WIQH</sub> , t <sub>WIQL</sub>		8T		ns
$\overline{\text{POLL}}$ Setup Time (to CLKOUT ↑)	t <sub>SPLK</sub>		30		ns
NMI High-/Low-Level Width	t <sub>WNIH</sub> , t <sub>WNIL</sub>		5		μs
$\overline{\text{CTS}}$ Low-Level Width	t <sub>WCTL</sub>		2T		ns
INT Setup Time (to CLKOUT ↑)	t <sub>SIRK</sub>		30		ns
$\overline{\text{INTAK}} \downarrow$ Delay Time from CLKOUT ↓	t <sub>DKIA</sub>		15	80	ns
INT Hold Time (from $\overline{\text{INTAK}} \downarrow$ )	t <sub>HIAIQ</sub>		0		ns
$\overline{\text{INTAK}}$ Low-Level Width	t <sub>WIAL</sub>		2T - 30		ns
$\overline{\text{INTAK}}$ High-Level Width	t <sub>WIAH</sub>		T - 30		ns
Data Delay Time from $\overline{\text{INTAK}} \downarrow$	t <sub>DIAD</sub>			2T - 130	ns
Data Hold Time (from $\overline{\text{INTAK}} \uparrow$ )	t <sub>HIAD</sub>		0	0.5T	ns
$\overline{\text{SCK0}}$ Cycle Time	t <sub>CYTK</sub>		1000		ns
$\overline{\text{SCK0}}$ High-/Low-Level Width	t <sub>WSTH</sub> , t <sub>WSTL</sub>		450		ns
TxD Delay Time from $\overline{\text{SCK0}} \downarrow$	t <sub>DTKD</sub>			210	ns
TxD Hold Time (from $\overline{\text{SCK0}} \downarrow$ )	t <sub>HTKD</sub>		20		ns
$\overline{\text{CTS0}}$ Cycle Time	t <sub>CYRK</sub>		1000		ns
$\overline{\text{CTS0}}$ High-/Low-Level Width	t <sub>WSRH</sub> , t <sub>WSRL</sub>		420		ns
RxD Setup/Hold Time (to/from $\overline{\text{CTS0}} \uparrow$ )	t <sub>SRDK</sub> , t <sub>HKRD</sub>		80		ns

**Remark** n indicates the number of wait states. No wait is "n = 0".

(2)  $\mu$ PD70325-10 ( $T_A = -10$  to  $+70^\circ\text{C}$ ,  $V_{DD} = +5.0\text{ V} \pm 5\%$ )

Parameter	Symbol	Test Conditions	MIN.	MAX.	Unit
X1 Input Cycle Time	$t_{CYX}$		49	250	ns
X1 Input High-/Low-Level Width	$t_{WXH}, t_{WXL}$		16		ns
X1 Input Rise/Fall Time	$t_{XR}, t_{XF}$			15	ns
CLKOUT Output Cycle Time	$t_{CYK}$	$f_x/2, T = t_{CYK}$	100	2000	ns
CLKOUT Output High-/Low-Level Width	$t_{WKH}, t_{WKL}$		$0.5T - 12$		ns
CLKOUT Output Rise/Fall Time	$t_{KR}, t_{KF}$			12	ns
Input Rise/Fall Time	$t_{IR}, t_{IF}$	Except $\overline{\text{RESET}}$ , NMI, X1 and X2		20	ns
	$t_{IRS}, t_{IFS}$	$\overline{\text{RESET}}$ , NMI		30	ns
Output Rise/Fall Time	$t_{OR}, t_{OF}$	Except CLKOUT		15	ns
Address Delay Time from CLKOUT	$t_{DKA}$		15	75	ns
Data Input Delay Time from Address	$t_{DADR}$			$(n + 1.5)T - 60$	ns
Data Delay Time from $\overline{\text{MREQ}} \downarrow$	$t_{DMRD}$			$(n + 1)T - 50$	ns
Data Delay Time from $\overline{\text{MSTB}} \downarrow$	$t_{DMSD}$			$(n + 0.5)T - 50$	ns
$\overline{\text{MSTB}} \downarrow$ Delay Time from $\overline{\text{MREQ}} \downarrow$	$t_{DMRMS}$		$0.5T - 20$	$0.5T + 30$	ns
$\overline{\text{MREQ}}$ Low-Level Width	$t_{WMRL}$		$(n + 1)T - 25$	$(n + 1)T + 25$	ns
Address Hold Time (from $\overline{\text{MREQ}} \uparrow$ )	$t_{HMA}$		$0.5T - 30$		ns
Data Input Hold Time (from $\overline{\text{MREQ}} \uparrow$ )	$t_{HMDR}$		0		ns
Control Signal Recovery Time	$t_{RVC}$		$T - 25$		ns
Data Output Delay Time from Address	$t_{DADW}$		$0.5T - 30$	$0.5T + 50$	ns
Address Setup Time (to $\overline{\text{MREQ}} \downarrow$ )	$t_{DAMR}$		$0.5T - 30$		ns
Address Setup Time (to $\overline{\text{MSTB}} \downarrow$ )	$t_{DAMS}$		$T - 30$		ns
$\overline{\text{MSTB}}$ Low-Level Width	$t_{WMSL}$		$(n + 0.5)T - 25$	$(n + 0.5)T + 25$	ns
Data Output Setup Time (to $\overline{\text{MSTB}} \uparrow$ )	$t_{SDM}$		$(n + 1)T - 50$		ns
Data Output Hold Time (from $\overline{\text{MSTB}} \uparrow$ )	$t_{HMDW}$		$0.5T - 30$		ns
Address Setup Time (to $\overline{\text{IOSTB}} \downarrow$ )	$t_{DAIS}$		$0.5T - 30$		ns
Data Delay Time from $\overline{\text{IOSTB}} \downarrow$	$t_{DISD}$			$(n + 1)T - 50$	ns
$\overline{\text{IOSTB}}$ Low-Level Width	$t_{WISL}$		$(n + 1)T - 25$		ns
Address Hold Time (from $\overline{\text{IOSTB}} \uparrow$ )	$t_{HISA}$		$0.5T - 30$		ns
Data Input Hold Time (from $\overline{\text{IOREQ}} \uparrow$ )	$t_{HISDR}$		0		ns
Data Output Setup Time (to $\overline{\text{IOSTB}} \uparrow$ )	$t_{SDIS}$		$(n + 1)T - 50$		ns
Data Output Hold Time (from $\overline{\text{IOSTB}} \uparrow$ )	$t_{HISDW}$		$0.5T - 30$		ns
$\overline{\text{DMARQ}}$ Setup Time (to $\overline{\text{MREQ}} \downarrow$ )	$t_{SDADQ}$	Demand release mode, $n \geq 2$		$(n - 1)T - 50$	ns
$\overline{\text{DMARQ}}$ Hold Time (from $\overline{\text{DMAAK}} \downarrow$ )	$t_{HDADQ}$	Demand release mode	0		ns
$\overline{\text{DMAAK}}$ Output Low-Level Width	$t_{WDMRL}$	Read operation	$(n + 1.5)T - 25$		ns
$\overline{\text{TC}} \downarrow$ Delay Time from $\overline{\text{DMAAK}} \downarrow$	$t_{DDATC}$			$0.5T + 35$	ns
$\overline{\text{TC}}$ Low-Level Width	$t_{WTCL}$		$(n + 2)T - 25$		ns
$\overline{\text{DMAAK}}$ Output Low-Level Width	$t_{WDMWL}$	Write operation	$(n + 1)T - 25$		ns
Address Setup Time (to $\overline{\text{REFRQ}} \downarrow$ )	$t_{DARF}$		$0.5T - 30$		ns
$\overline{\text{REFRQ}}$ Low-Level Width	$t_{WRFL}$		$(n + 1)T - 25$		ns
Address Hold Time (from $\overline{\text{REFRQ}} \uparrow$ )	$t_{HRFA}$		$0.5T - 30$		ns

**Remark** n indicates the number of wait states. No wait is "n = 0".

Parameter	Symbol	Test Conditions	MIN.	MAX.	Unit
RESET Low-Level Width	t <sub>WRS1</sub>	STOP mode release/ power-ON reset	30		ms
	t <sub>WRS2</sub>	System reset	5		μs
READY Setup Time (to MREQ ↓, IOSTB ↓)	t <sub>SCRY0</sub>	n ≥ 2		T – 80	ns
	t <sub>SCRY</sub>	n ≥ 3		(n – 1)T – 80	ns
READY Hold Time (from MREQ ↓, IOSTB ↓)	t <sub>HCRY0</sub>	n = 2	T		ns
	t <sub>HCRY</sub>	n ≥ 3	(n – 1)T		ns
	t <sub>HCRY1</sub>	n ≥ 3	(n – 2)T		ns
HLDQR Setup Time (to CLKOUT ↑)	t <sub>SHQK</sub>		25		ns
HLDAR ↓ Delay Time from CLKOUT ↑	t <sub>DKHA</sub>		15	70	ns
HLDAR ↓ Delay Time from Bus Float	t <sub>CFHA</sub>		T – 35		ns
Bus Output Delay Time from HLDAR ↑	t <sub>DHAC</sub>		T – 35		ns
HLDAR ↑ Delay Time from HLDQR ↓	t <sub>DHQA</sub>			3T + 160	ns
Bus Output Delay Time from HLDQR ↓	t <sub>DHQC</sub>		3T + 30		ns
HLDQR Low-Level Width	t <sub>WHQL</sub>		1.5T		ns
HLDAR Low-Level Width	t <sub>WHAL</sub>		T		ns
INT, DMARQ Setup Time (to CLKOUT ↑)	t <sub>SIQK</sub>		25		ns
INT, DMARQ High-/Low-Level Width	t <sub>WIQH</sub> , t <sub>WIQL</sub>		8T		ns
POLL Setup Time (to CLKOUT ↑)	t <sub>SPLK</sub>		25		ns
NMI High-/Low-Level Width	t <sub>WNH</sub> , t <sub>WNL</sub>		5		μs
CTS Low-Level Width	t <sub>WCTL</sub>		2T		ns
INT Setup Time (to CLKOUT ↑)	t <sub>SIRK</sub>		25		ns
INTAR ↓ Delay Time from CLKOUT ↓	t <sub>DKIA</sub>		15	70	ns
INT Hold Time (from INTAR ↓)	t <sub>HIAIQ</sub>		0		ns
INTAR Low-Level Width	t <sub>WIAL</sub>		2T – 25		ns
INTAR High-Level Width	t <sub>WIAH</sub>		T – 25		ns
Data Delay Time from INTAR ↓	t <sub>DIAD</sub>			2T – 100	ns
Data Hold Time (from INTAR ↑)	t <sub>HIAD</sub>		0	0.5T	ns
SCK0 Cycle Time	t <sub>CYTK</sub>		1000		ns
SCK0 High-/Low-Level Width	t <sub>WSTH</sub> , t <sub>WSTL</sub>		450		ns
TxD Delay Time from SCK0 ↓	t <sub>DTKD</sub>			210	ns
TxD Hold Time (from SCK0 ↓)	t <sub>HTKD</sub>		20		ns
CTS0 Cycle Time	t <sub>CYRK</sub>		1000		ns
CTS0 High-/Low-Level Width	t <sub>WSRH</sub> , t <sub>WSRL</sub>		420		ns
RxD Setup/Hold Time (to/from CTS0 ↑)	t <sub>SRDK</sub> , t <sub>HKRD</sub>		80		ns

**Remark** n indicates the number of wait states. No wait is “n = 0”.

## COMPARATOR CHARACTERISTICS

$\mu$ PD70325-8 ( $T_A = -10$  to  $+70^\circ\text{C}$ ,  $V_{DD} = +5.0\text{ V} \pm 10\%$ )

$\mu$ PD70325-10 ( $T_A = -10$  to  $+70^\circ\text{C}$ ,  $V_{DD} = +5.0\text{ V} \pm 5\%$ )

Parameter	Symbol	Test Conditions	MIN.	TYP.	MAX.	Unit
Comparator Accuracy	$V_{ACOMP}$				$\pm 100$	mV
Threshold Voltage	$V_{TH}$		0		$V_{DD} + 0.1$	V
Compare Time	$t_{COMP}$		64		65	$t_{CYK}$
PT Input Voltage	$V_{IPT}$		0		$V_{DD}$	V

## DATA MEMORY STOP MODE LOW SUPPLY VOLTAGE DATA HOLDING CHARACTERISTICS

( $T_A = -10$  to  $+70^\circ\text{C}$ )

Parameter	Symbol	Test Conditions	MIN.	MAX.	Unit
Data Hold Supply Voltage	$V_{DDDR}$		2.5	5.5	V
$V_{DD}$ Rise/Fall Time	$t_{RVD}$ , $t_{FVD}$		200		$\mu\text{s}$



**DATA HOLDING TIMING**

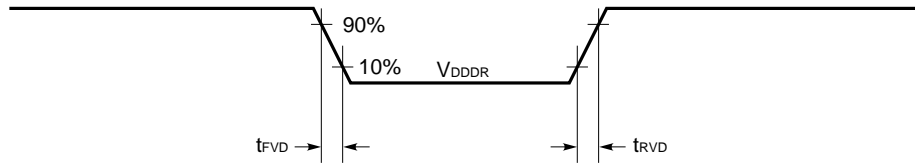

**AC TEST INPUT WAVEFORM (Except RESET, NMI, X1 and X2)**

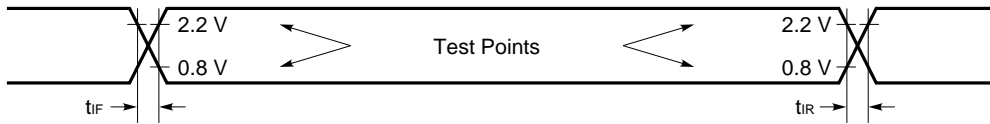

**AC TEST INPUT WAVEFORM (RESET, NMI, X1 and X2)**

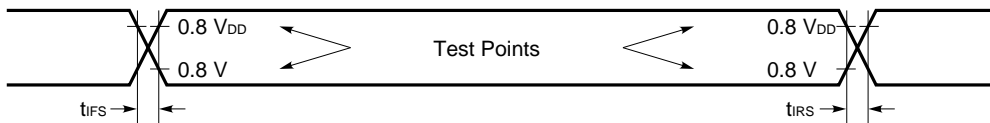

**AC TEST OUTPUT TEST POINTS**

Output load condition: 100 pF

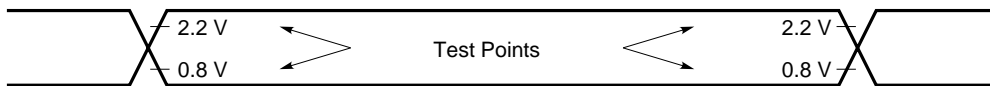

**LOAD CONDITION**

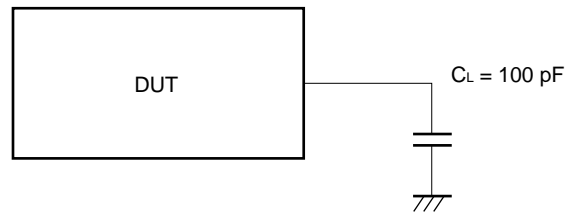

**Caution** When the load capacity exceeds 100 pF depending on the circuit configuration, make the load capacity of this device less than 100 pF by inserting a buffer, etc.

## CLOCK TIMING

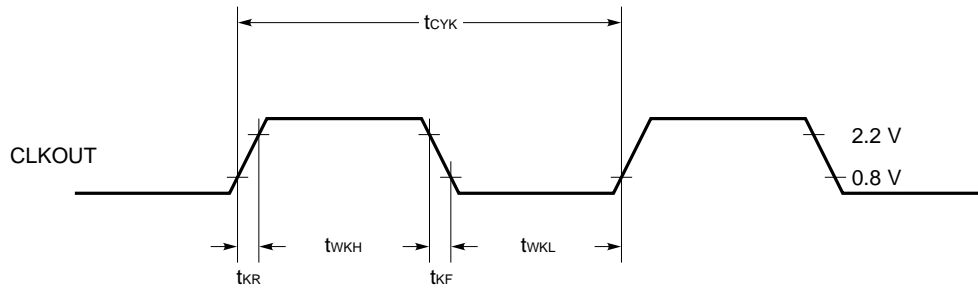
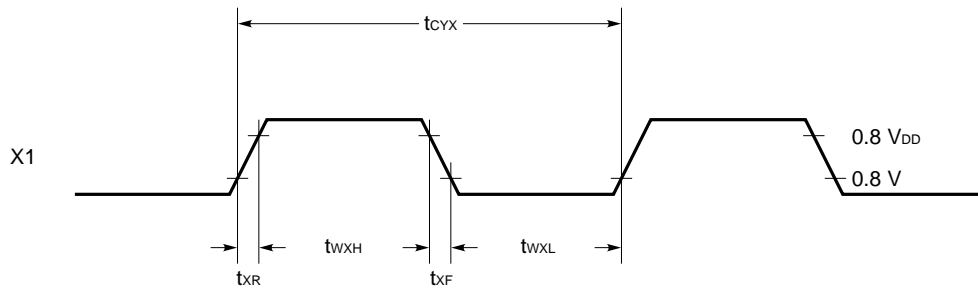

## $\overline{POLL}$ INPUT TIMING

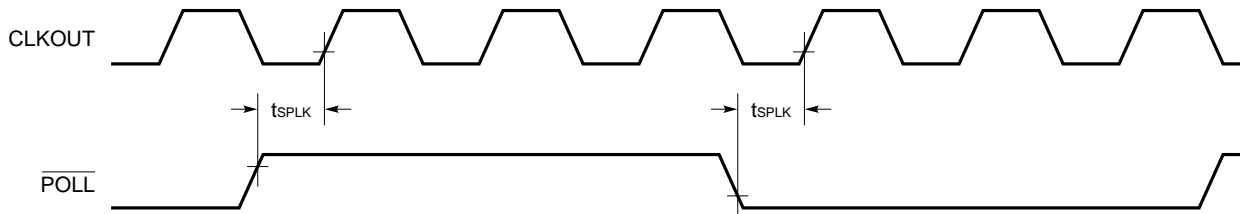

## $\overline{CTS0}$ AND $\overline{CTS1}$ INPUT TIMING

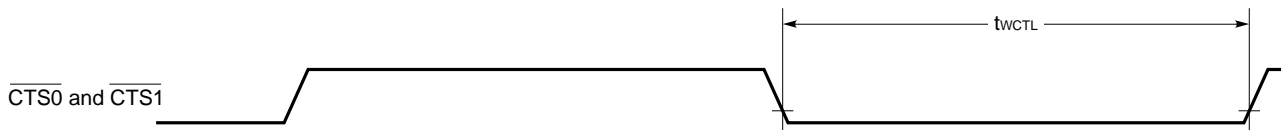

**INTERRUPT INPUT/DMA INPUT TIMING**

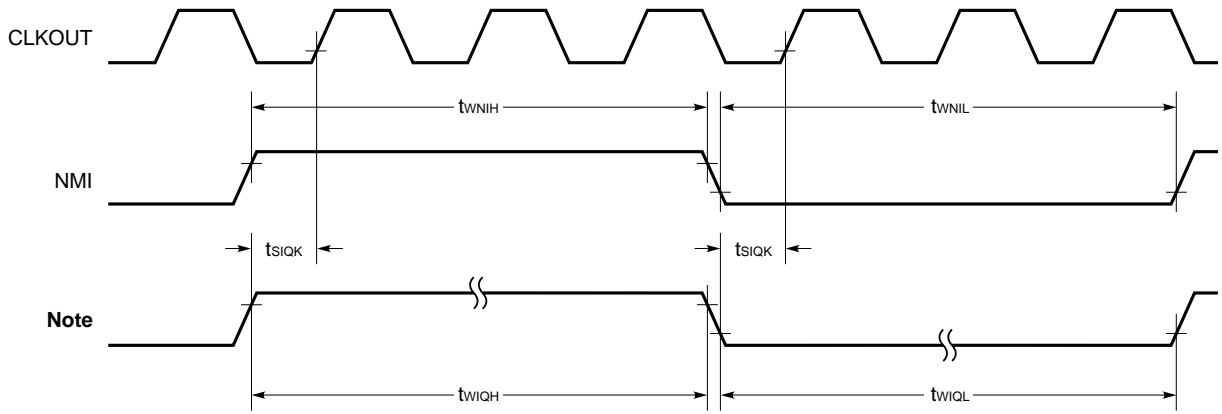

**Note**  $\overline{\text{INTP0}}$  to  $\overline{\text{INTP2}}$ ,  $\overline{\text{DMARQ0}}$  to  $\overline{\text{DMARQ1}}$

**RESET INPUT TIMING**

**When STOP mode is released/at power-on reset:**

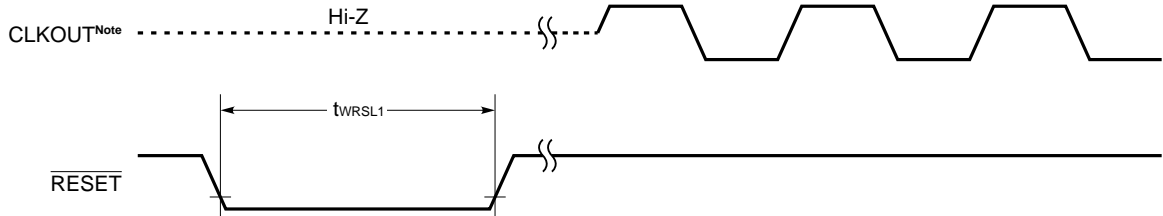

**Note** CLKOUT signal is output after CLKOUT output is set.

**When system is reset:**

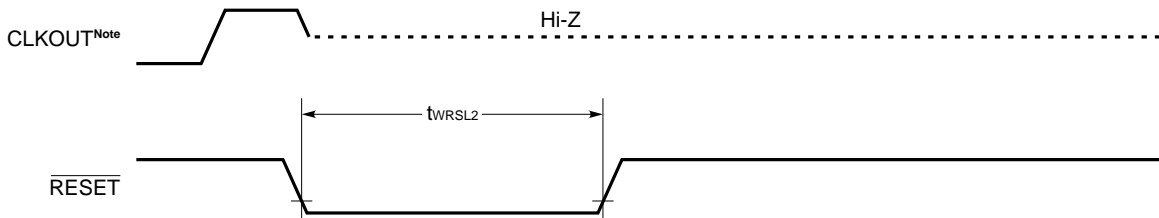

**Note** CLKOUT output is set to input port by  $\overline{\text{RESET}}$  input.

## READY TIMING

When 2 wait states are inserted:

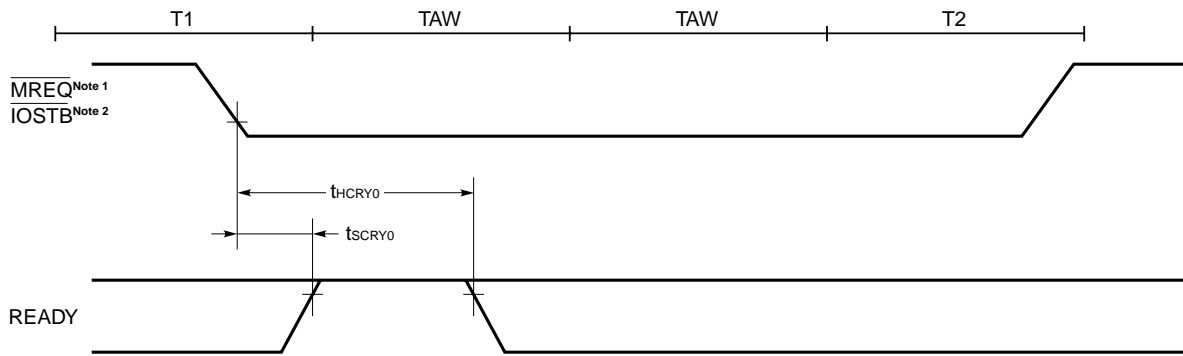

When  $(n - 2)$  extra wait states are inserted [ $n \geq 3$ ]:

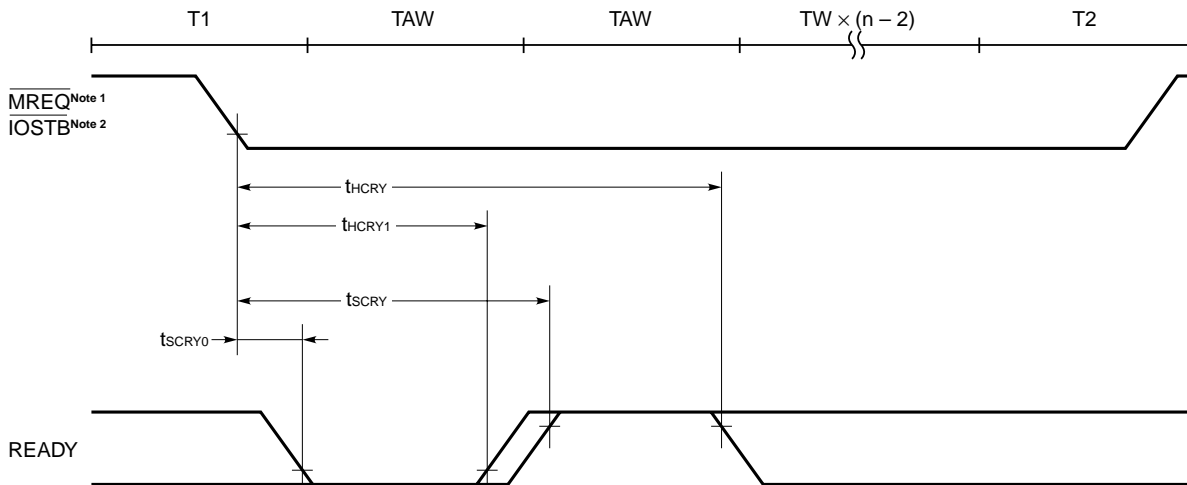

- Notes**
1. In case of memory cycle
  2. In case of I/O cycle

**Caution** The wait state insertion by the external  $\text{READY}$  signal is necessary to make the value of wait control register (WTC) "11" (2 waits + insertion state by  $\text{READY}$  pin).

## SERIAL OPERATION

### When transmitting data in I/O interface mode

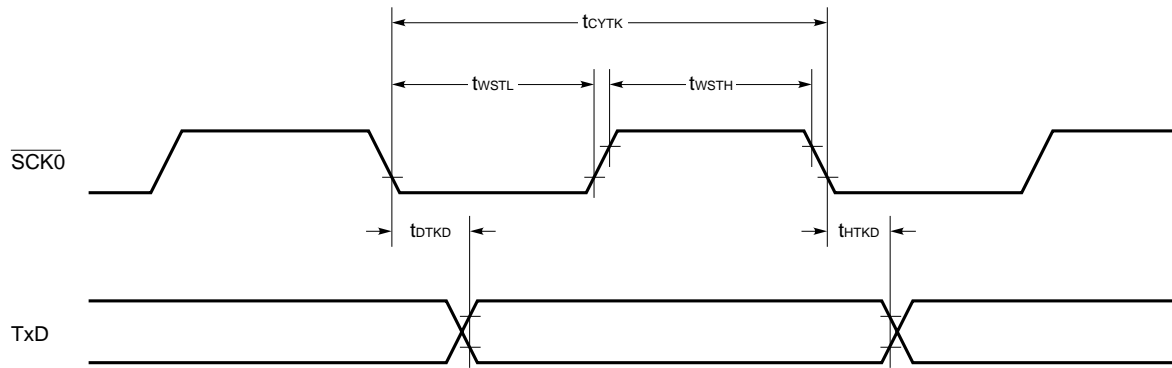

### When receiving data in I/O interface mode

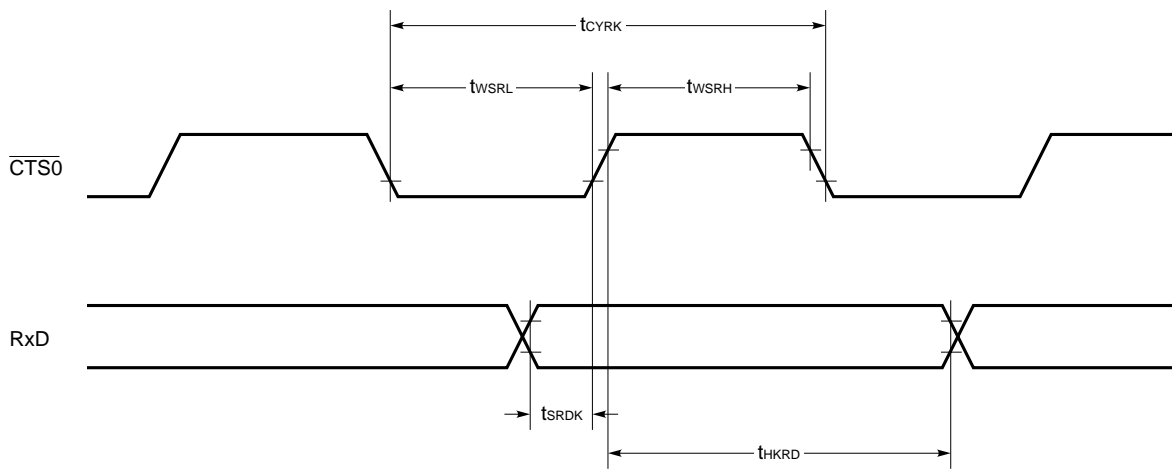

# READ OPERATION

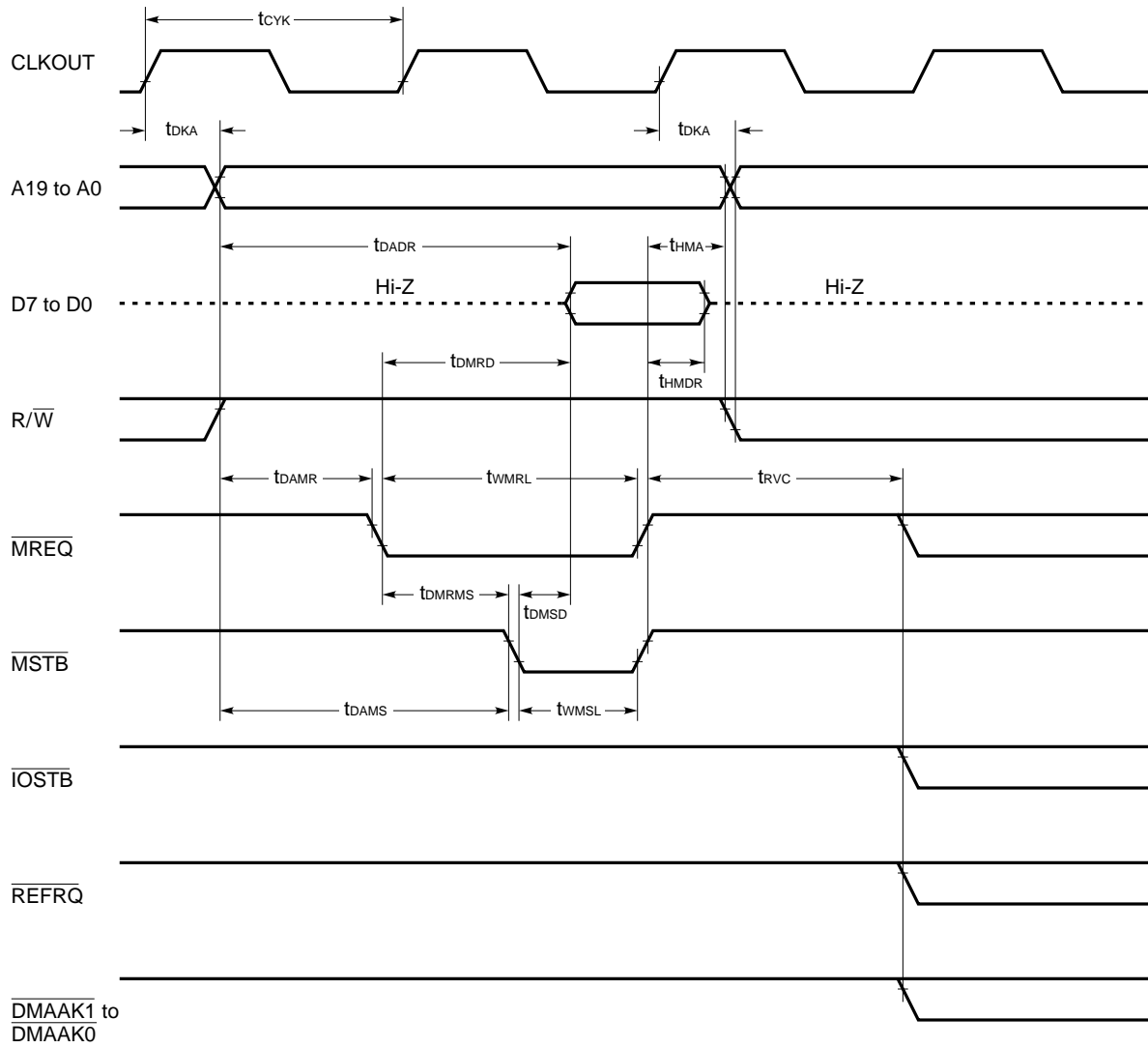

## WRITE OPERATION

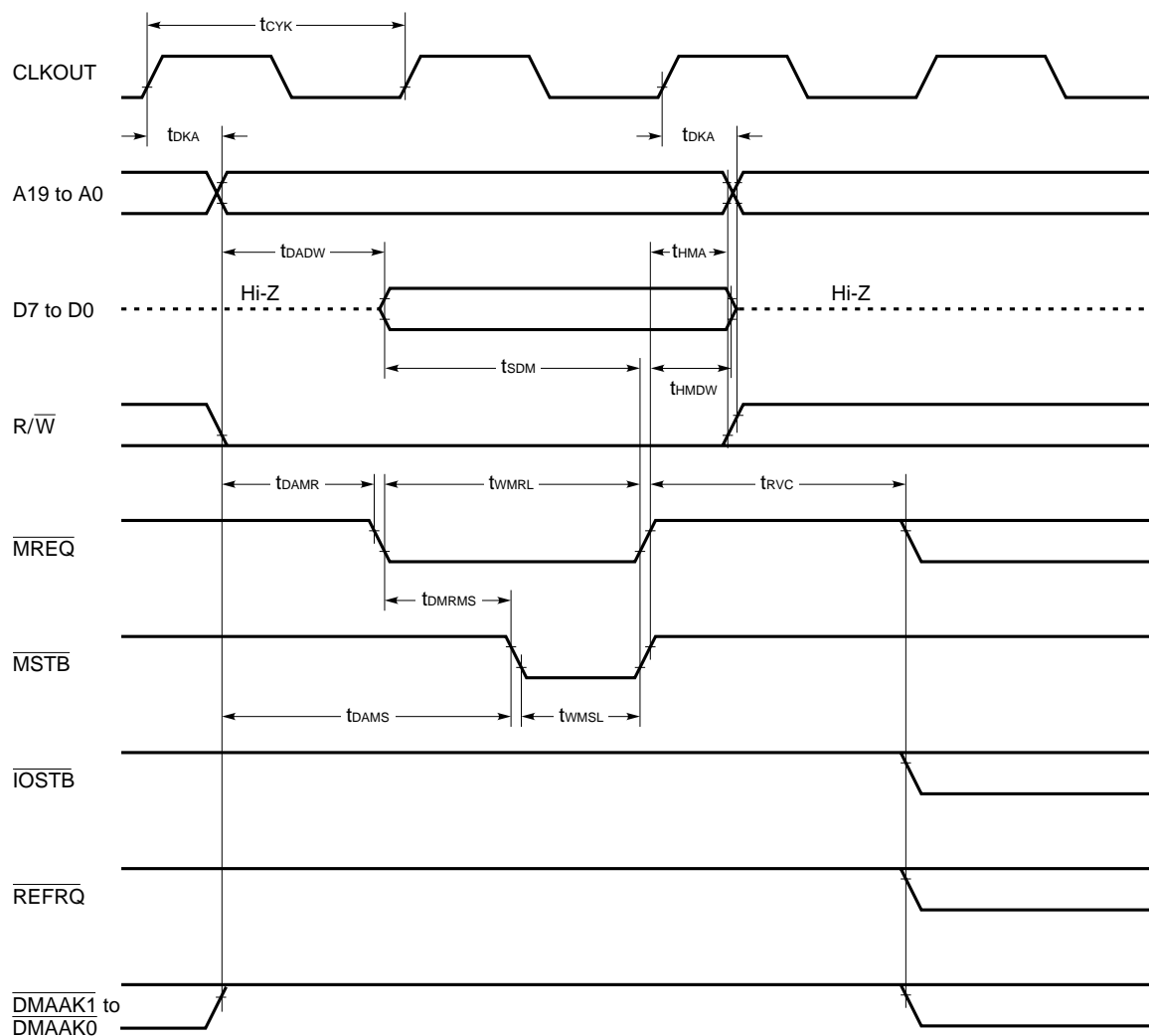

# I/O READ TIMING

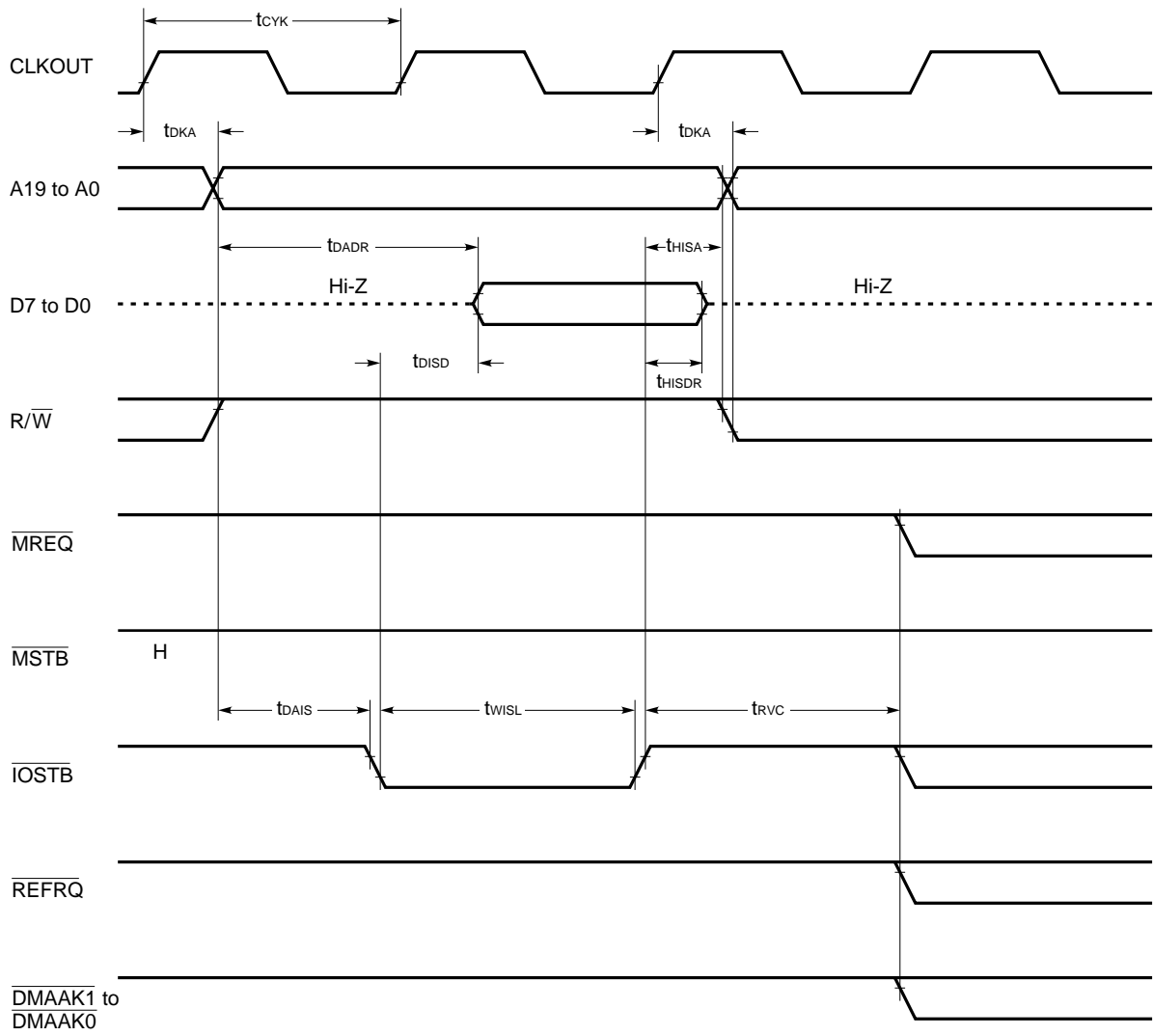



# I/O WRITE TIMING

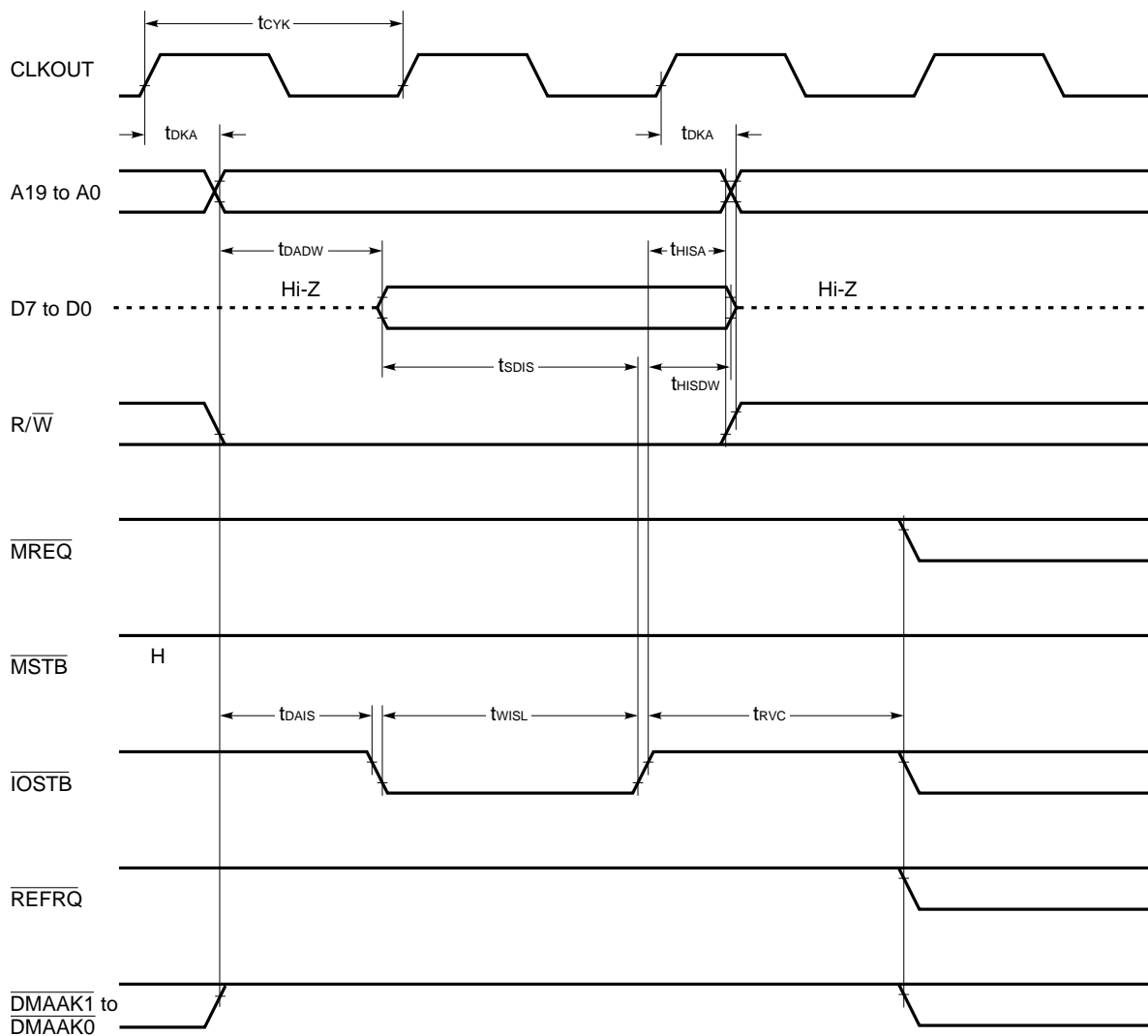

### DMA (I/O → MEMORY) TIMING

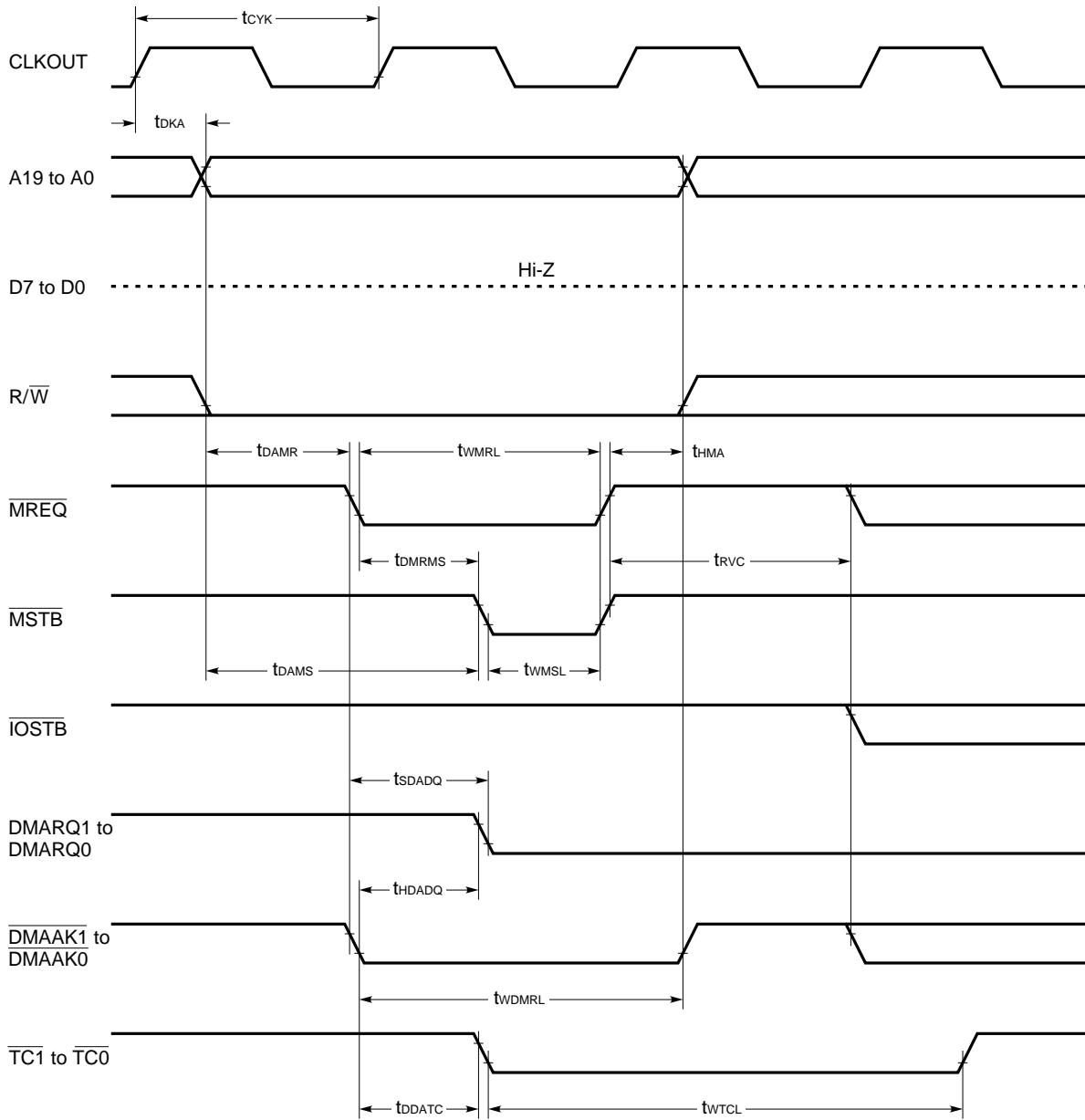

### DMA (MEMORY → I/O) TIMING

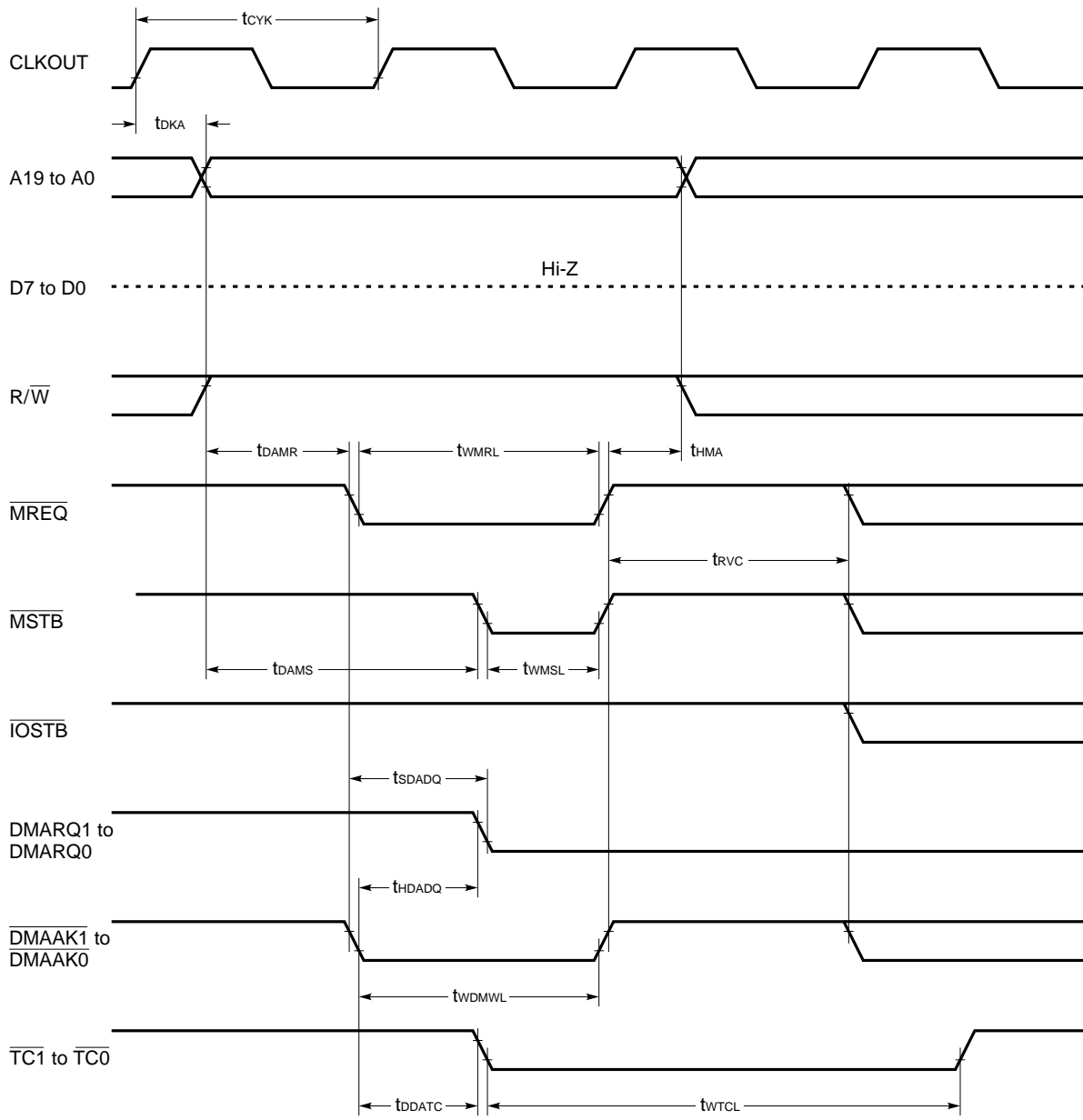

# REFRESH TIMING

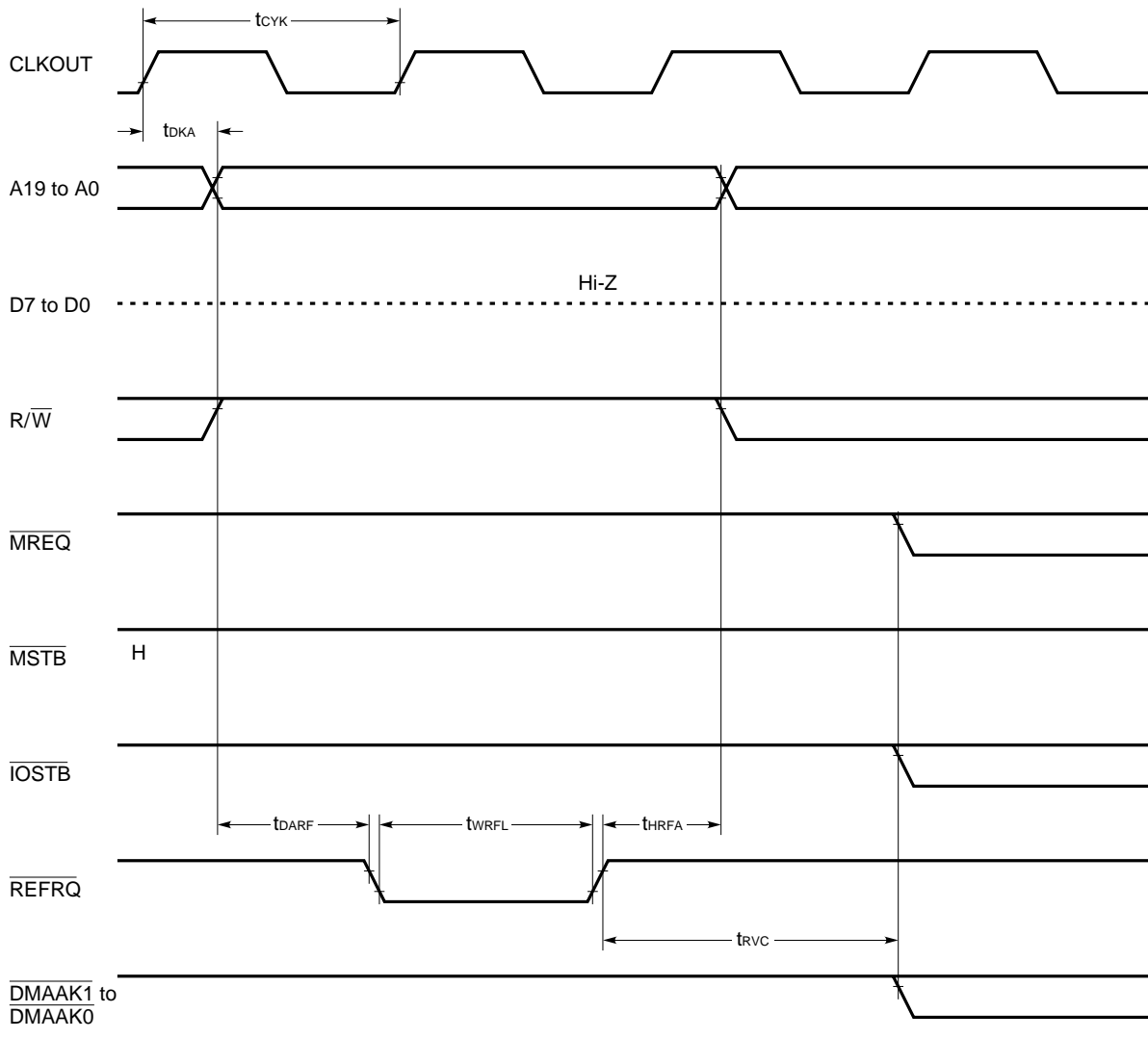

## HOLD REQUEST/ACKNOWLEDGE TIMING

### Normal mode

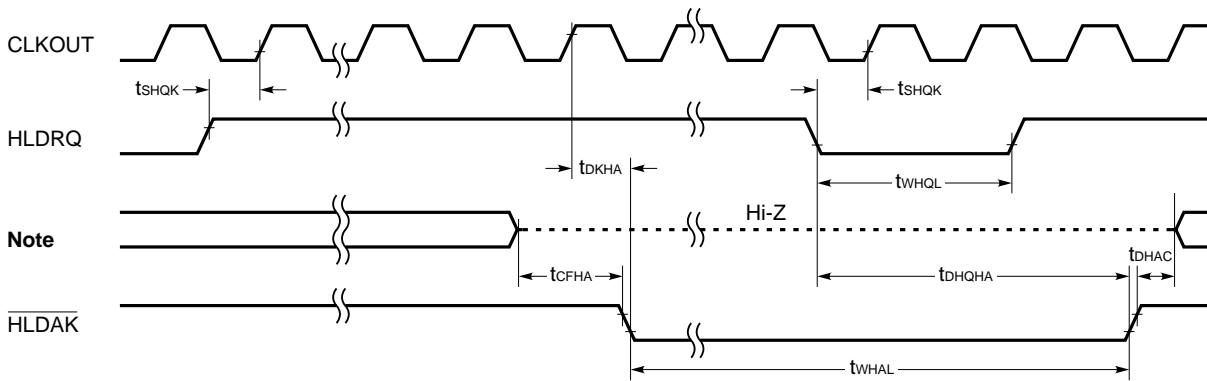

### Releasing HOLD mode at refreshing time

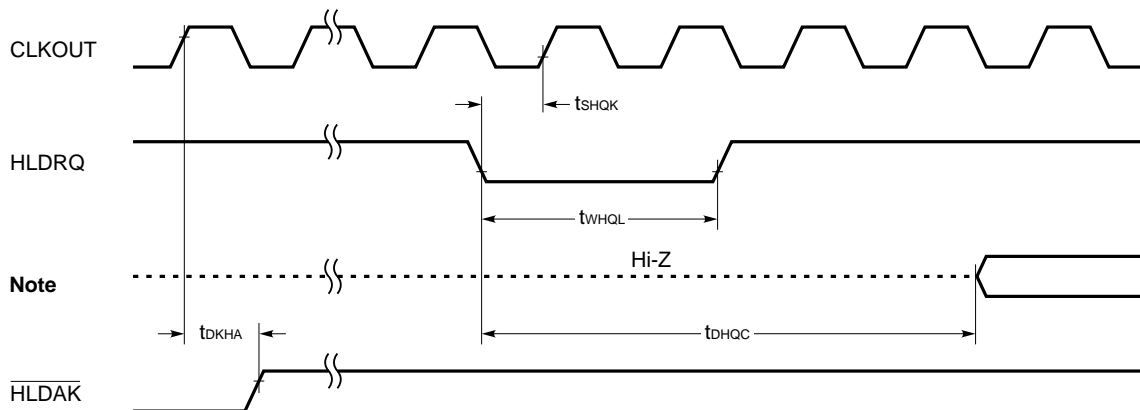

**Note** A19 to A0, D7 to D0,  $\overline{MREQ}$ ,  $\overline{MSTB}$ ,  $\overline{IOSTB}$ , R/W

## EXTERNAL INTERRUPT REQUEST/ACKNOWLEDGE TIMING

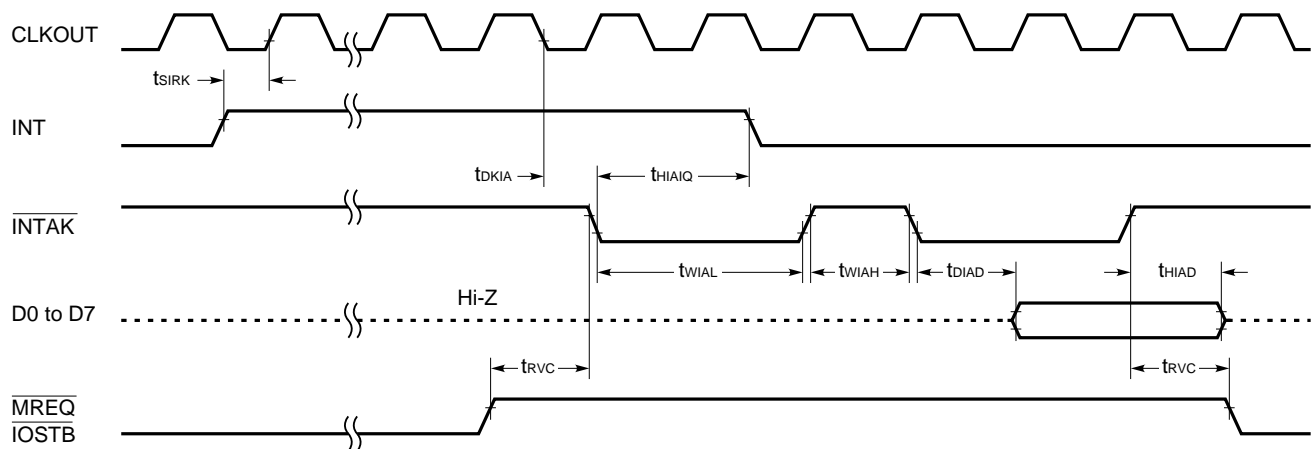

## CLOCK SYNCHRONIZATION TIMING

The V25 Family is designed to create access signals to memory and I/O, based on the  $\overline{\text{MREQ}}$  signal and  $\overline{\text{IOSTB}}$  signal. When V25 Family products are connected with memory and I/O, design is possible even if there are no AC characteristics based on the clock. The clock synchronization timing shown below is for executing accurate READY input control using the system clock.

### (1) $\mu\text{PD70325-8}$ ( $T_A = -10$ to $+70^\circ\text{C}$ , $V_{DD} = +5.0\text{ V} \pm 10\%$ )

Parameter	Symbol	Test Conditions	MIN.	MAX.	Unit
Data Delay Time from CLKOUT	$t_{DKD}$		65	115	ns
Data Input Setup Time	$t_{SDK}$		15		ns
Data Input Hold Time	$t_{HKD}$		40		ns
$\overline{\text{MREQ}}$ Delay Time	$t_{DKMR}$		10	55	ns
$\overline{\text{IOSTB}}$ Delay Time	$t_{DKIS}$		10	55	ns
READY Setup Time	$t_{SRYK}$		20		ns
READY Hold Time	$t_{HKRY}$		40		ns

### ★ (2) $\mu\text{PD70325-10}$ ( $T_A = -10$ to $+70^\circ\text{C}$ , $V_{DD} = +5.0\text{ V} \pm 5\%$ )

Parameter	Symbol	Test Conditions	MIN.	MAX.	Unit
Data Delay Time from CLKOUT	$t_{DKD}$		60	110	ns
Data Input Setup Time	$t_{SDK}$		10		ns
Data Input Hold Time	$t_{HKD}$		35		ns
$\overline{\text{MREQ}}$ Delay Time	$t_{DKMR}$		10	55	ns
$\overline{\text{IOSTB}}$ Delay Time	$t_{DKIS}$		10	55	ns
READY Setup Time	$t_{SRYK}$		15		ns
READY Hold Time	$t_{HKRY}$		40		ns

## READY TIMING

When 2 wait states are inserted:

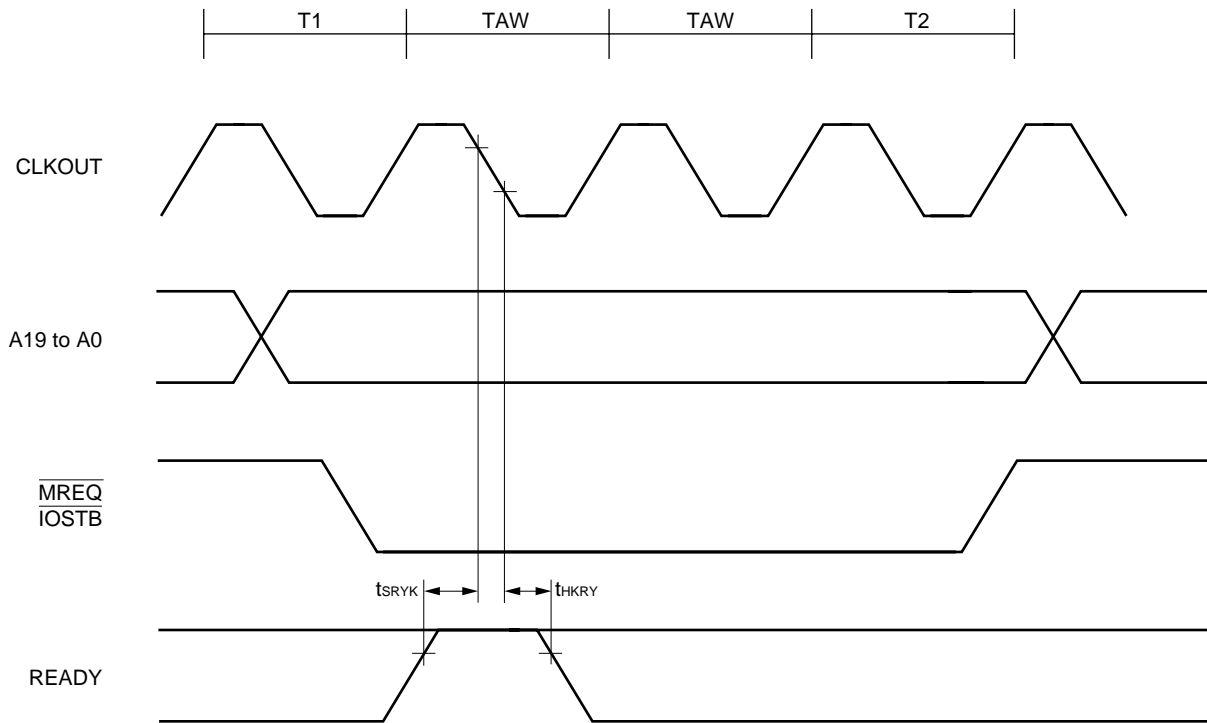

When 1 extra wait state is inserted:

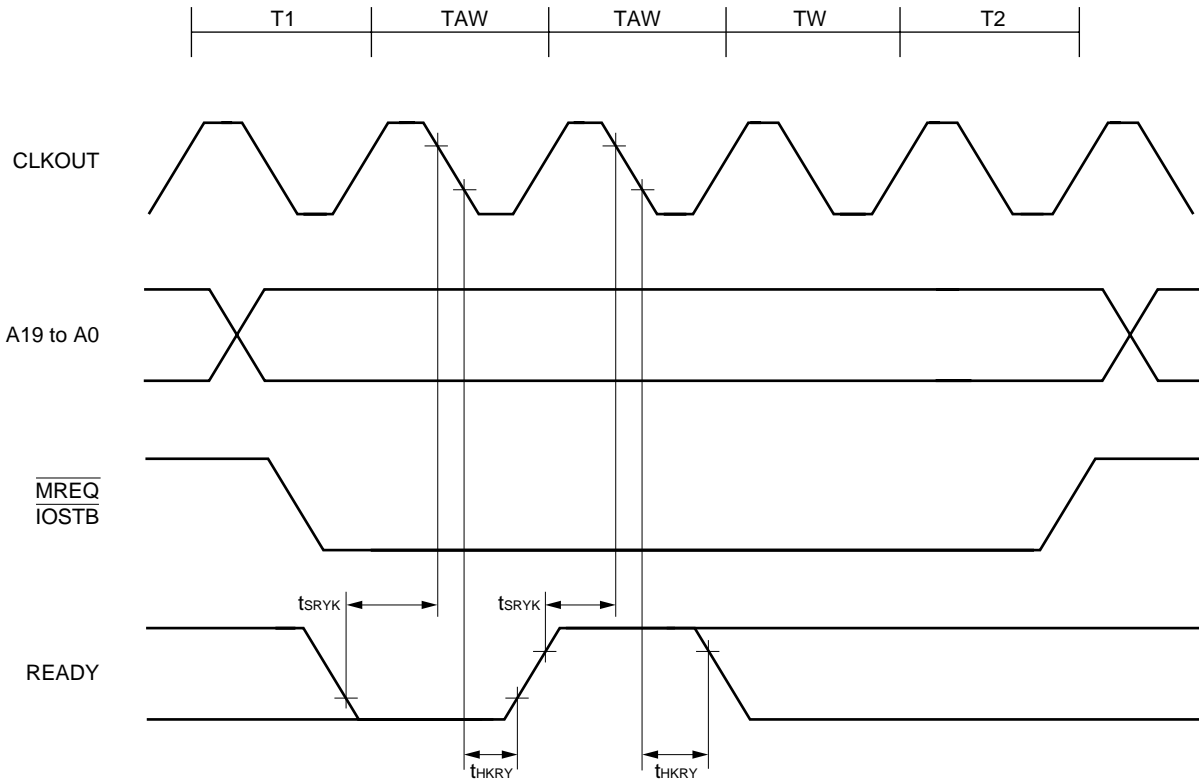

## MEMORY READ OPERATION

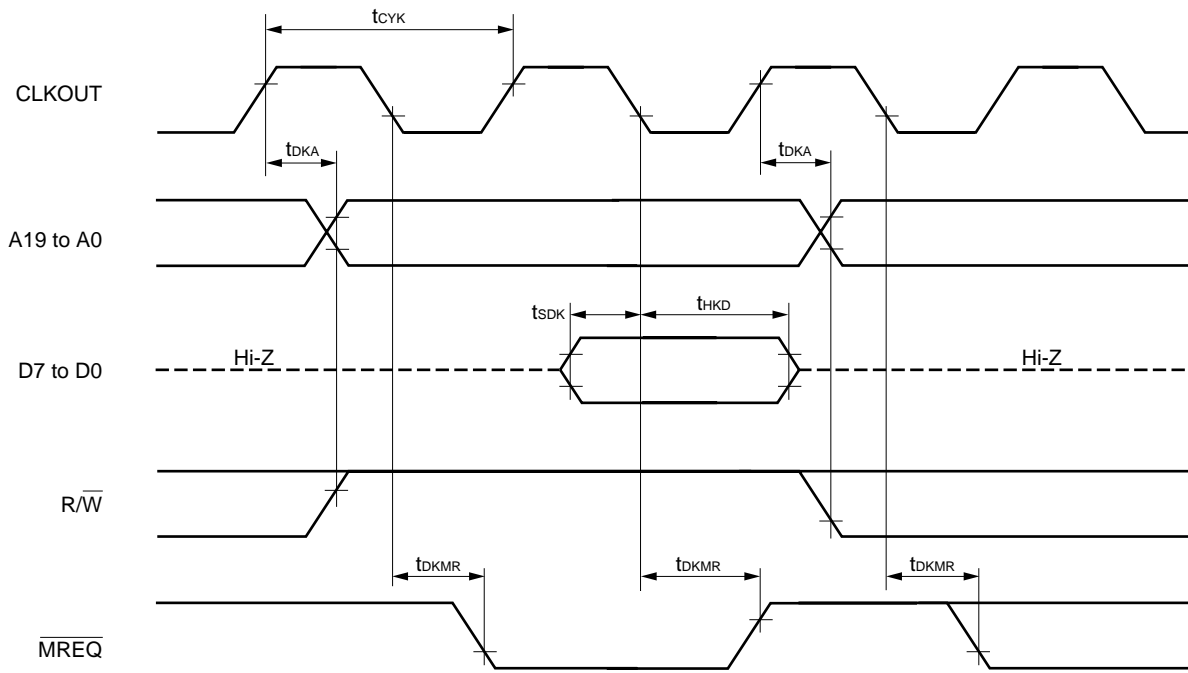

## MEMORY WRITE OPERATION

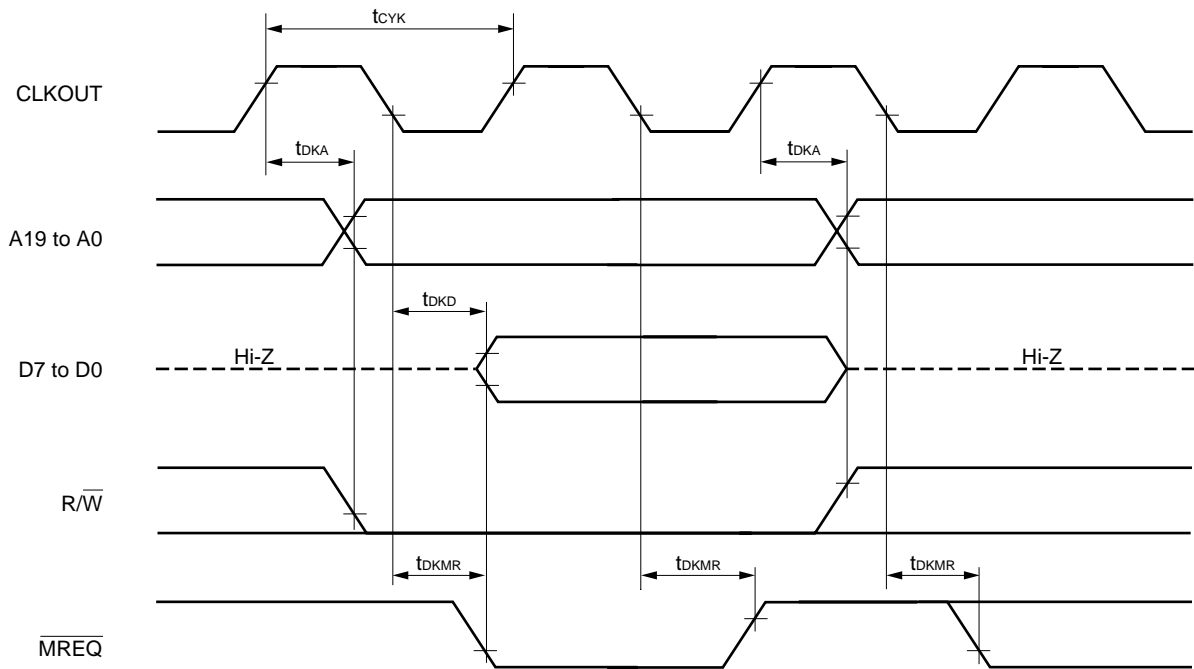



### I/O READ TIMING

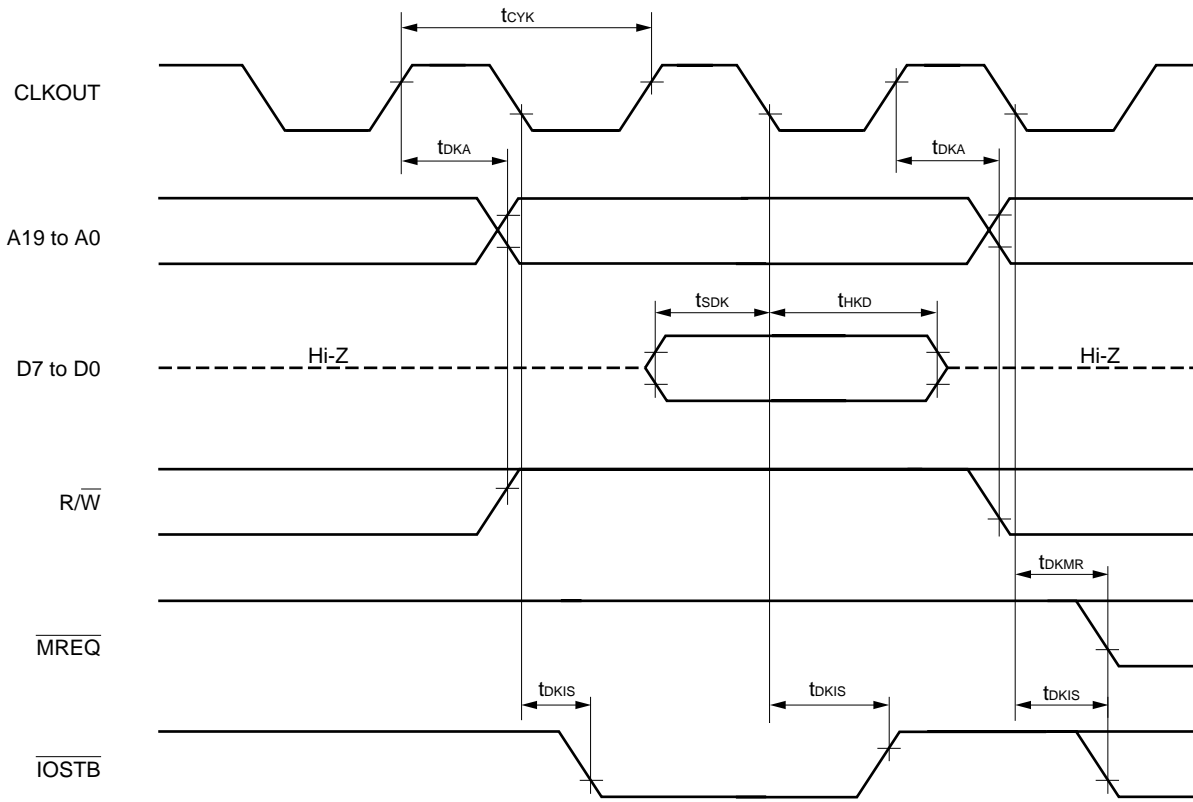

### I/O WRITE TIMING

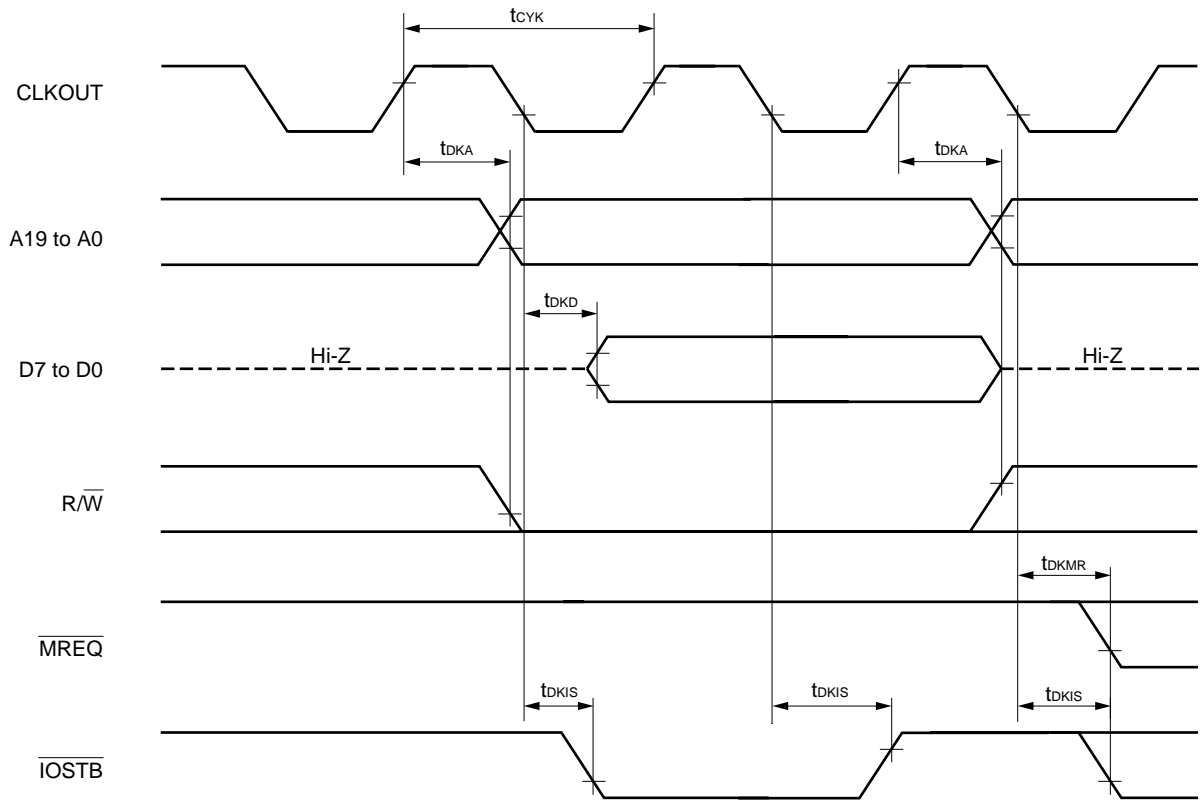

★ 4. PACKAGE DRAWINGS

94 PIN PLASTIC QFP (□ 20)

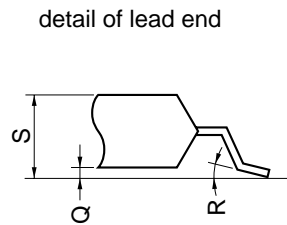
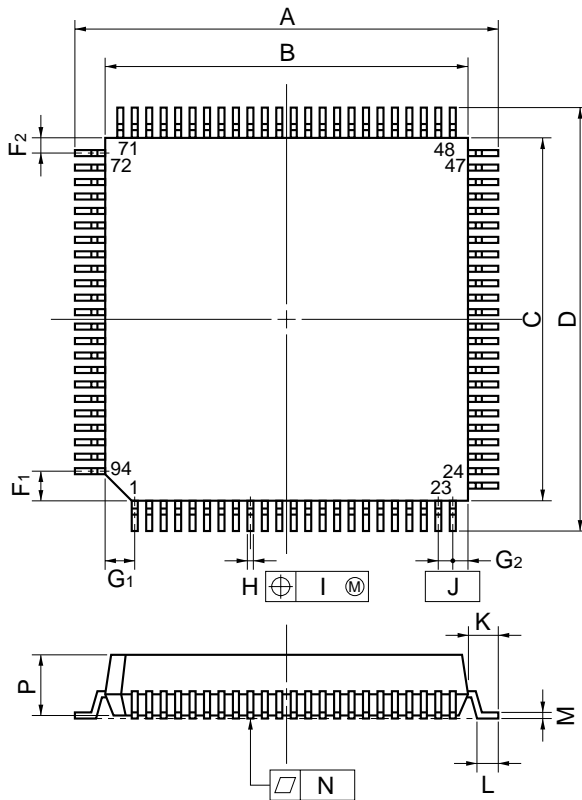

**NOTE**

Each lead centerline is located within 0.15 mm (0.006 inch) of its true position (T.P.) at maximum material condition.

ITEM	MILLIMETERS	INCHES
A	23.2±0.4	0.913 <sup>+0.017</sup> <sub>-0.016</sub>
B	20.0±0.2	0.787 <sup>+0.009</sup> <sub>-0.008</sub>
C	20.0±0.2	0.787 <sup>+0.009</sup> <sub>-0.008</sub>
D	23.2±0.4	0.913 <sup>+0.017</sup> <sub>-0.016</sub>
F <sub>1</sub>	1.6	0.063
F <sub>2</sub>	0.8	0.031
G <sub>1</sub>	1.6	0.063
G <sub>2</sub>	0.8	0.031
H	0.35±0.10	0.014 <sup>+0.004</sup> <sub>-0.005</sub>
I	0.15	0.006
J	0.8 (T.P.)	0.031 (T.P.)
K	1.6±0.2	0.063±0.008
L	0.8±0.2	0.031 <sup>+0.009</sup> <sub>-0.008</sub>
M	0.15 <sup>+0.10</sup> <sub>-0.05</sub>	0.006 <sup>+0.004</sup> <sub>-0.003</sub>
N	0.10	0.004
P	3.7	0.146
Q	0.1±0.1	0.004±0.004
R	5°±5°	5°±5°
S	4.0 MAX.	0.158 MAX.

S94GJ-80-5BG-3

# 84 PIN PLASTIC QFJ (□1150 mil)

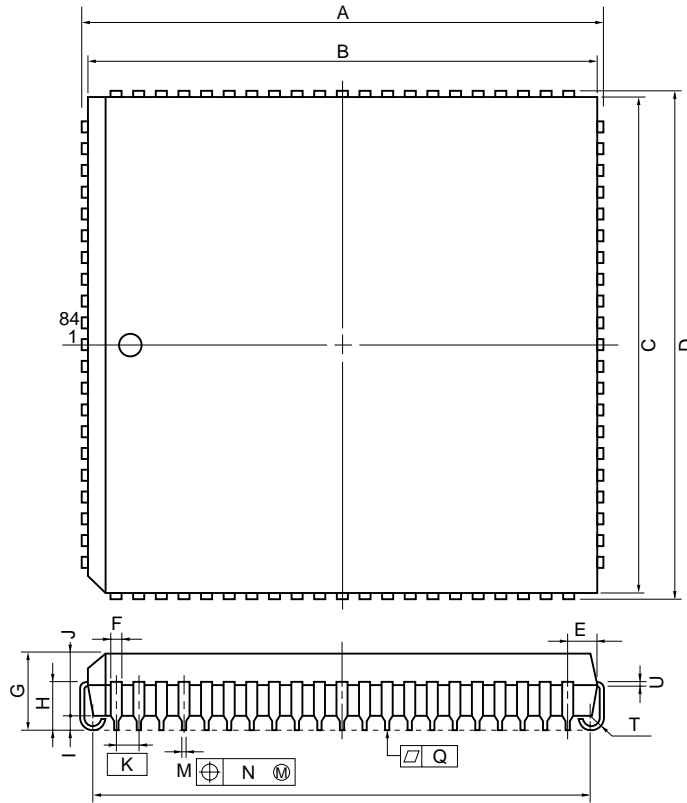

**NOTE**

Each lead centerline is located within 0.12 mm (0.005 inch) of its true position (T.P.) at maximum material condition.

**P84L-50A3-2**

ITEM	MILLIMETERS	INCHES
A	30.2±0.2	1.189±0.008
B	29.28	1.153
C	29.28	1.153
D	30.2±0.2	1.189±0.008
E	1.94±0.15	0.076 <sup>+0.007</sup> <sub>-0.006</sub>
F	0.6	0.024
G	4.4±0.2	0.173 <sup>+0.009</sup> <sub>-0.008</sub>
H	2.8±0.2	0.110 <sup>+0.009</sup> <sub>-0.008</sub>
I	0.9 MIN.	0.035 MIN.
J	3.4	0.134
K	1.27 (T.P.)	0.050 (T.P.)
M	0.40±0.10	0.016 <sup>+0.004</sup> <sub>-0.005</sub>
N	0.12	0.005
P	28.20±0.20	1.110 <sup>+0.009</sup> <sub>-0.008</sub>
Q	0.15	0.006
T	R 0.8	R 0.031
U	0.20 <sup>+0.10</sup> <sub>-0.05</sub>	0.008 <sup>+0.004</sup> <sub>-0.002</sub>

## ★ 5. RECOMMENDED SOLDERING CONDITIONS

The following conditions must be met when soldering this product.

For more details, refer to our document “SEMICONDUCTOR DEVICE MOUNTING TECHNOLOGY MANUAL” (C10535E).

Please consult with our sales office when using other soldering process or under different soldering conditions.

**Table 5-1. Surface Mount Type Soldering Conditions**

(1)  $\mu$ PD70325GJ-8-5BG : 94-pin plastic QFP (20 × 20 mm)

$\mu$ PD70325GJ-10-5BG : 94-pin plastic QFP (20 × 20 mm)

Soldering Process	Soldering Conditions	Symbol
Infrared ray reflow	Package peak temperature: 235°C, Reflow time: 30 seconds or less (at 210°C or higher), Number of reflow processes: 3 or less Exposure limit <sup>Note</sup> : 7 days (36 hours pre-baking is required at 125°C afterwards)	IR35-367-3
VPS	Package peak temperature: 215°C, Reflow time: 40 seconds or less (at 200°C or higher), Number of reflow processes: 3 or less Exposure limit <sup>Note</sup> : 7 days (36 hours pre-baking is required at 125°C afterwards)	VP15-367-3
Wave soldering	Solder temperature: 260°C or below, Flow time: 10 seconds or less, Number of flow processes: 1 Exposure limit <sup>Note</sup> : 7 days (36 hours pre-baking is required at 125°C afterwards) Pre-heating temperature: 120°C max. (package surface temperature)	WS60-367-1
Partial heating method	Pin temperature: 300°C or below, Flow time: 3 seconds or less (per side of device)	—

(2)  $\mu$ PD70325L-8 : 84-pin plastic QFJ (1150 × 1150 mil)

$\mu$ PD70325L-10 : 84-pin plastic QFJ (1150 × 1150 mil)

Soldering Process	Soldering Conditions	Symbol
VPS	Package peak temperature: 215°C, Reflow time: 40 seconds or less (at 200°C or higher), Number of reflow processes: 1 Exposure limit <sup>Note</sup> : 2 days (16 hours pre-baking is required at 125°C afterwards)	VP15-162-1
Partial heating method	Pin temperature: 300°C or below, Flow time: 3 seconds or less (per side of device)	—

**Note** Exposure limit before soldering after dry-pack package is opened. Storage conditions: 25°C and relative humidity at 65% or less.

**Caution** Use of more than one soldering process should be avoided (except for partial heating method).

[MEMO]

## NOTES FOR CMOS DEVICES

### ① PRECAUTION AGAINST ESD FOR SEMICONDUCTORS

**Note:** Strong electric field, when exposed to a MOS device, can cause destruction of the gate oxide and ultimately degrade the device operation. Steps must be taken to stop generation of static electricity as much as possible, and quickly dissipate it once, when it has occurred. Environmental control must be adequate. When it is dry, humidifier should be used. It is recommended to avoid using insulators that easily build static electricity. Semiconductor devices must be stored and transported in an anti-static container, static shielding bag or conductive material. All test and measurement tools including work bench and floor should be grounded. The operator should be grounded using wrist strap. Semiconductor devices must not be touched with bare hands. Similar precautions need to be taken for PW boards with semiconductor devices on it.

### ② HANDLING OF UNUSED INPUT PINS FOR CMOS

**Note:** No connection for CMOS device inputs can be cause of malfunction. If no connection is provided to the input pins, it is possible that an internal input level may be generated due to noise, etc., hence causing malfunction. CMOS devices behave differently than Bipolar or NMOS devices. Input levels of CMOS devices must be fixed high or low by using a pull-up or pull-down circuitry. Each unused pin should be connected to  $V_{DD}$  or GND with a resistor, if it is considered to have a possibility of being an output pin. All handling related to the unused pins must be judged device by device and related specifications governing the devices.

### ③ STATUS BEFORE INITIALIZATION OF MOS DEVICES

**Note:** Power-on does not necessarily define initial status of MOS device. Production process of MOS does not define the initial operation status of the device. Immediately after the power source is turned ON, the devices with reset function have not yet been initialized. Hence, power-on does not guarantee out-pin levels, I/O settings or contents of registers. Device is not initialized until the reset signal is received. Reset operation must be executed immediately after power-on for devices having reset function.

# Regional Information

Some information contained in this document may vary from country to country. Before using any NEC product in your application, please contact the NEC office in your country to obtain a list of authorized representatives and distributors. They will verify:

- Device availability
- Ordering information
- Product release schedule
- Availability of related technical literature
- Development environment specifications (for example, specifications for third-party tools and components, host computers, power plugs, AC supply voltages, and so forth)
- Network requirements

In addition, trademarks, registered trademarks, export restrictions, and other legal issues may also vary from country to country.

## **NEC Electronics Inc. (U.S.)**

Santa Clara, California  
Tel: 408-588-6000  
800-366-9782  
Fax: 408-588-6130  
800-729-9288

## **NEC Electronics (Germany) GmbH**

Duesseldorf, Germany  
Tel: 0211-65 03 02  
Fax: 0211-65 03 490

## **NEC Electronics (UK) Ltd.**

Milton Keynes, UK  
Tel: 01908-691-133  
Fax: 01908-670-290

## **NEC Electronics Italiana s.r.l.**

Milano, Italy  
Tel: 02-66 75 41  
Fax: 02-66 75 42 99

## **NEC Electronics (Germany) GmbH**

Benelux Office  
Eindhoven, The Netherlands  
Tel: 040-2445845  
Fax: 040-2444580

## **NEC Electronics (France) S.A.**

Velizy-Villacoublay, France  
Tel: 01-30-67 58 00  
Fax: 01-30-67 58 99

## **NEC Electronics (France) S.A.**

Spain Office  
Madrid, Spain  
Tel: 01-504-2787  
Fax: 01-504-2860

## **NEC Electronics (Germany) GmbH**

Scandinavia Office  
Taeby, Sweden  
Tel: 08-63 80 820  
Fax: 08-63 80 388

## **NEC Electronics Hong Kong Ltd.**

Hong Kong  
Tel: 2886-9318  
Fax: 2886-9022/9044

## **NEC Electronics Hong Kong Ltd.**

Seoul Branch  
Seoul, Korea  
Tel: 02-528-0303  
Fax: 02-528-4411

## **NEC Electronics Singapore Pte. Ltd.**

United Square, Singapore 1130  
Tel: 253-8311  
Fax: 250-3583

## **NEC Electronics Taiwan Ltd.**

Taipei, Taiwan  
Tel: 02-719-2377  
Fax: 02-719-5951

## **NEC do Brasil S.A.**

Cumbica-Guarulhos-SP, Brasil  
Tel: 011-6465-6810  
Fax: 011-6465-6829

**Related documents** V25+, V35+ User's Manual — Hardware IEU-706 (Japanese version)  
V25, V35 Family User's Manual — Instructions U12120J (Japanese version)

**Reference document** Electrical Characteristics for Microcomputer IEI-601 (Japanese version)

**The related documents indicated in this publication may include preliminary versions. However, preliminary versions are not marked as such.**

**V25, V25+, V35, and V35+ are trademarks of NEC Corporation.**

No part of this document may be copied or reproduced in any form or by any means without the prior written consent of NEC Corporation. NEC Corporation assumes no responsibility for any errors which may appear in this document.

NEC Corporation does not assume any liability for infringement of patents, copyrights or other intellectual property rights of third parties by or arising from use of a device described herein or any other liability arising from use of such device. No license, either express, implied or otherwise, is granted under any patents, copyrights or other intellectual property rights of NEC Corporation or others.

While NEC Corporation has been making continuous effort to enhance the reliability of its semiconductor devices, the possibility of defects cannot be eliminated entirely. To minimize risks of damage or injury to persons or property arising from a defect in an NEC semiconductor device, customers must incorporate sufficient safety measures in its design, such as redundancy, fire-containment, and anti-failure features.

NEC devices are classified into the following three quality grades:

"Standard", "Special", and "Specific". The Specific quality grade applies only to devices developed based on a customer designated "quality assurance program" for a specific application. The recommended applications of a device depend on its quality grade, as indicated below. Customers must check the quality grade of each device before using it in a particular application.

Standard: Computers, office equipment, communications equipment, test and measurement equipment, audio and visual equipment, home electronic appliances, machine tools, personal electronic equipment and industrial robots

Special: Transportation equipment (automobiles, trains, ships, etc.), traffic control systems, anti-disaster systems, anti-crime systems, safety equipment and medical equipment (not specifically designed for life support)

Specific: Aircrafts, aerospace equipment, submersible repeaters, nuclear reactor control systems, life support systems or medical equipment for life support, etc.

The quality grade of NEC devices is "Standard" unless otherwise specified in NEC's Data Sheets or Data Books. If customers intend to use NEC devices for applications other than those specified for Standard quality grade, they should contact an NEC sales representative in advance.

Anti-radioactive design is not implemented in this product.