



Integrated  
Circuit  
Systems, Inc.

# ICS840051

## FEMTOCLOCKS™ CRYSTAL-TO-LVCMOS/LVTTL CLOCK GENERATOR

### GENERAL DESCRIPTION



The ICS840051 is a Gigabit Ethernet Clock Generator and a member of the HiPerClockS™ family of high performance devices from ICS. The ICS840051 can synthesize 10 Gigabit Ethernet, SONET, or Serial ATA reference clock frequencies with the appropriate choice of crystal and output divider. The ICS840051 has excellent phase jitter performance and is packaged in a small 8-pin TSSOP, making it ideal for use in systems with limited board space.

### FEATURES

- 1 LVCMOS/LVTTL output, 15Ω output impedance
- Crystal oscillator interface designed for 18pF parallel resonant crystals
- Output frequency range: 70MHz - 170MHz
- VCO range: 560MHz - 680MHz
- RMS phase jitter at 155.52MHz (1.875MHz - 20MHz): 0.48ps (typical)
- RMS phase noise at 155.52MHz

#### Offset Noise Power

100Hz .....	-99.7 dBc/Hz
1KHz .....	-120 dBc/Hz
10KHz .....	-128 dBc/Hz
100KHz .....	-127 dBc/Hz

- 3.3V operating supply
- 0°C to 70°C ambient operating temperature
- Lead-Free fully RoHS compliant
- Industrial temperature information available upon request

### FREQUENCY TABLE

Inputs		Output Frequency (MHz)
Crystal Frequency (MHz)	FREQ_SEL	
20.141601	0	161.132812
20.141601	1	80.566406
19.53125	0	156.25
19.53125	1	78.125
19.44	0	155.52
19.44	1	77.76
18.75	0	150
18.75	1	75

### BLOCK DIAGRAM

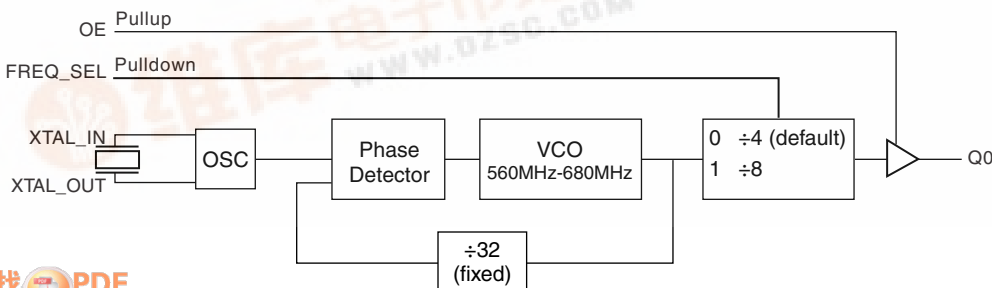

### PIN ASSIGNMENT

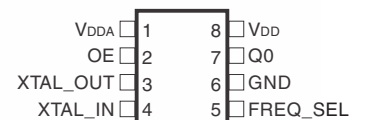

### ICS840051

**8-Lead TSSOP**  
4.40mm x 3.0mm x 0.925mm  
package body  
**G Package**  
Top View





Integrated  
Circuit  
Systems, Inc.

# ICS840051

## FEMTOCLOCKS™ CRYSTAL-TO-LVCMOS/LVTTL CLOCK GENERATOR

**TABLE 1. PIN DESCRIPTIONS**

Number	Name	Type		Description
1	V <sub>DDA</sub>	Power		Analog supply pin.
2	OE	Input	Pullup	Output enable pin. When HIGH, Q0 output is enabled. When LOW, forces Q0 to HiZ state. LVCMOS/LVTTL interface levels. See Table 3A.
3, 4	XTAL_OUT, XTAL_IN	Input		Crystal oscillator interface. XTAL_IN is the input, XTAL_OUT is the output.
5	FREQ_SEL	Input	Pulldown	Frequency select pin. LVCMOS/LVTTL interface levels. See Table 3B.
6	GND	Power		Power supply ground.
7	Q0	Output		Single-ended clock output. LVCMOS/LVTTL interface levels. 15Ω output impedance.
8	V <sub>DD</sub>	Power		Core supply pin.

NOTE: *Pullup and Pulldown* refer to internal input resistors. See Table 2, Pin Characteristics, for typical values.

**TABLE 2. PIN CHARACTERISTICS**

Symbol	Parameter	Test Conditions	Minimum	Typical	Maximum	Units
C <sub>IN</sub>	Input Capacitance			4		pF
C <sub>PD</sub>	Power Dissipation Capacitance	V <sub>DD</sub> , V <sub>DDA</sub> = 3.465V		7		pF
R <sub>PULLUP</sub>	Input Pullup Resistor			51		KΩ
R <sub>PULLDOWN</sub>	Input Pulldown Resistor			51		KΩ
R <sub>OUT</sub>	Output Impedance			15		Ω

**TABLE 3A. CONTROL FUNCTION TABLE**

Control Input	Output
<b>OE</b>	<b>Q0</b>
0	Hi-Z
1	Active

**TABLE 3B. FREQ\_SEL FUNCTION TABLE**

Control Input	N Divider
<b>FRE_SEL</b>	
0	÷4 (default)
1	÷8



Integrated  
Circuit  
Systems, Inc.

# ICS840051

## FEMTOCLOCKS™ CRYSTAL-TO-LVCMOS/LVTTL CLOCK GENERATOR

### ABSOLUTE MAXIMUM RATINGS

Supply Voltage, $V_{DD}$	4.6V
Inputs, $V_I$	-0.5V to $V_{DD} + 0.5V$
Outputs, $V_O$	-0.5V to $V_{DD} + 0.5V$
Package Thermal Impedance, $\theta_{JA}$	101.7°C/W (0 mps)
Storage Temperature, $T_{STG}$	-65°C to 150°C

NOTE: Stresses beyond those listed under Absolute Maximum Ratings may cause permanent damage to the device. These ratings are stress specifications only. Functional operation of product at these conditions or any conditions beyond those listed in the *DC Characteristics* or *AC Characteristics* is not implied. Exposure to absolute maximum rating conditions for extended periods may affect product reliability.

**TABLE 4A. POWER SUPPLY DC CHARACTERISTICS,  $V_{DD} = V_{DDA} = 3.3V \pm 5\%$ ,  $T_A = 0^\circ C$  TO  $70^\circ C$**

Symbol	Parameter	Test Conditions	Minimum	Typical	Maximum	Units
$V_{DD}$	Core Supply Voltage		3.135	3.3	3.465	V
$V_{DDA}$	Analog Supply Voltage		3.135	3.3	3.465	V
$I_{DD}$	Power Supply Current				60	mA
$I_{DDA}$	Analog Supply Current				10	mA

**TABLE 4B. LVCMOS/LVTTL DC CHARACTERISTICS,  $V_{DD} = V_{DDA} = 3.3V \pm 5\%$ ,  $T_A = 0^\circ C$  TO  $70^\circ C$**

Symbol	Parameter	Test Conditions	Minimum	Typical	Maximum	Units
$V_{IH}$	Input High Voltage		2		$V_{DD} + 0.3$	V
$V_{IL}$	Input Low Voltage		-0.3		0.8	V
$I_{IH}$	Input High Current	OE	$V_{DD} = V_{IN} = 3.465V$		5	$\mu A$
		FREQ_SEL	$V_{DD} = V_{IN} = 3.465V$		150	$\mu A$
$I_{IL}$	Input Low Current	OE	$V_{DD} = 3.465V, V_{IN} = 0V$	-150		$\mu A$
		FREQ_SEL	$V_{DD} = 3.465V, V_{IN} = 0V$	-5		$\mu A$
$V_{OH}$	Output High Voltage; NOTE 1		2.6			V
$V_{OL}$	Output Low Voltage; NOTE 1				0.5	V

NOTE 1: Outputs terminated with  $50\Omega$  to  $V_{DD}/2$ . See Parameter Measurement Information Section, "3.3V Output Load Test Circuit".

**TABLE 5. CRYSTAL CHARACTERISTICS**

Parameter	Test Conditions	Minimum	Typical	Maximum	Units
Mode of Oscillation		Fundamental			
Frequency		17.5		21.25	MHz
Equivalent Series Resistance (ESR)				50	$\Omega$
Shunt Capacitance				7	pF



Integrated  
Circuit  
Systems, Inc.

# ICS840051

## FEMTOCLOCKS™ CRYSTAL-TO-LVCMOS/LVTTL CLOCK GENERATOR

**TABLE 6. AC CHARACTERISTICS,  $V_{DD} = V_{DDA} = 3.3V \pm 5\%$ ,  $T_A = 0^\circ C$  TO  $70^\circ C$**

Symbol	Parameter	Test Conditions	Minimum	Typical	Maximum	Units
$f_{OUT}$	Output Frequency		70		170	MHz
$f_{jit}(\emptyset)$	RMS Phase Jitter ( Random); NOTE 1	155.52MHz, Integration Range: 1.875MHz - 20MHz		0.48		ps
		77.76MHz, Integration Range: 1.875MHz - 20MHz		0.45		ps
$t_R / t_F$	Output Rise/Fall Time	20% to 80%	200		500	ps
odc	Output Duty Cycle		48		52	%

NOTE 1: Please refer to the Phase Noise Plots.



Integrated  
Circuit  
Systems, Inc.

# ICS840051

FEMTOCLOCKS™ CRYSTAL-TO-  
LVCMOS/LVTTL CLOCK GENERATOR

### TYPICAL PHASE NOISE AT 155.52MHz

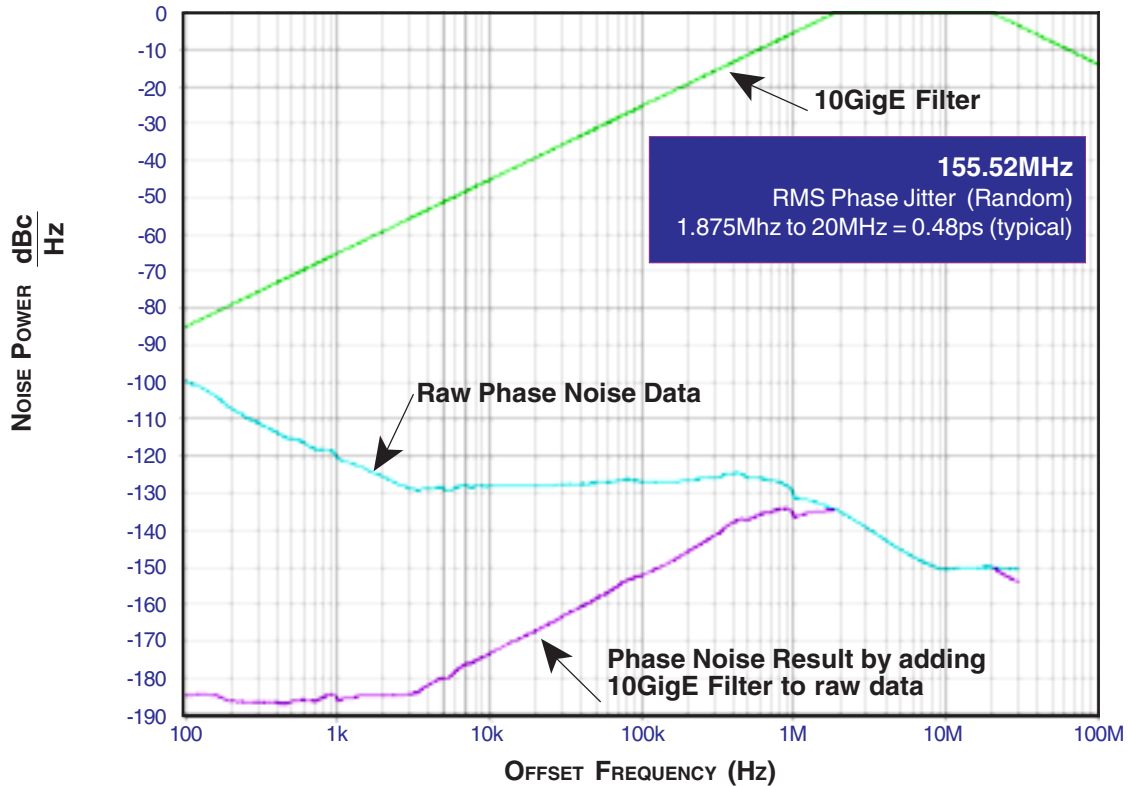

### TYPICAL PHASE NOISE AT 77.76MHz

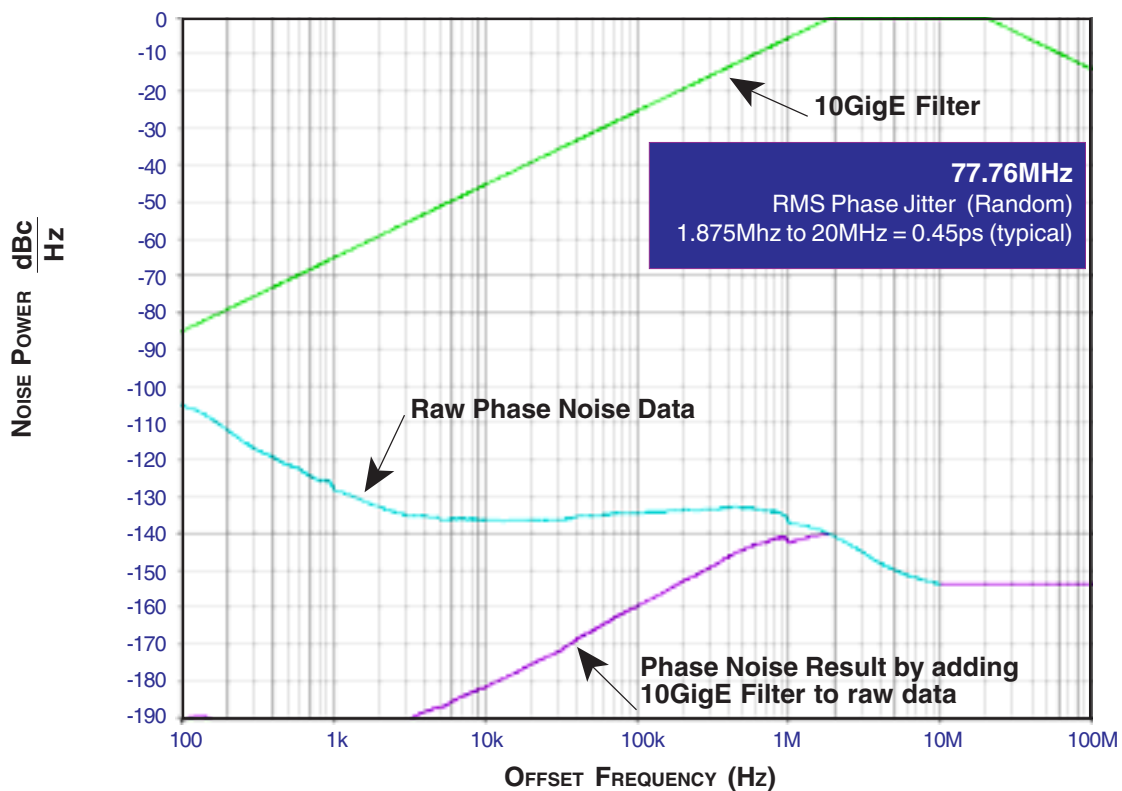



**PARAMETER MEASUREMENT INFORMATION**

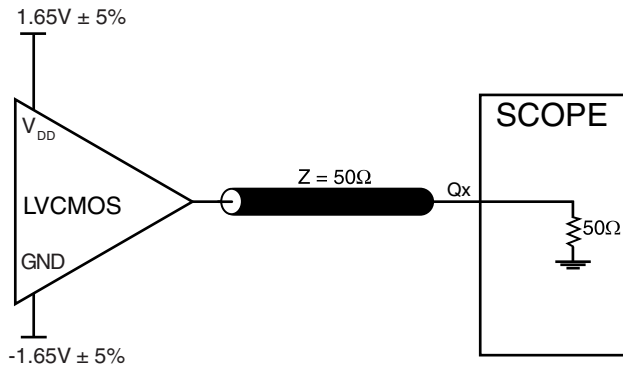

**3.3V OUTPUT LOAD AC TEST CIRCUIT**

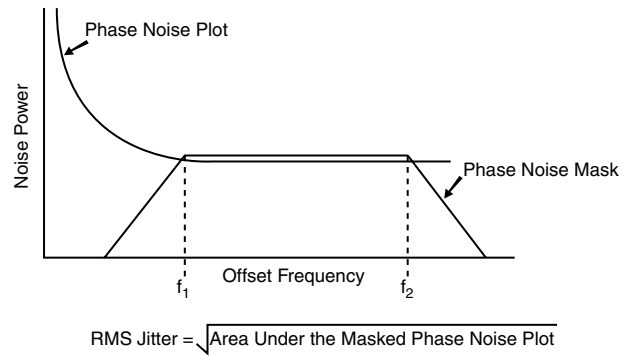

**RMS PHASE JITTER**

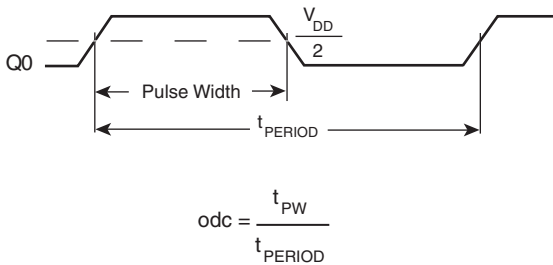

**OUTPUT DUTY CYCLE/PULSE WIDTH/PERIOD**

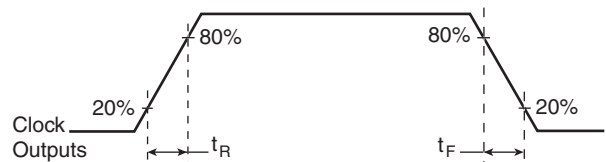

**OUTPUT RISE/FALL TIME**



## APPLICATION INFORMATION

### POWER SUPPLY FILTERING TECHNIQUES

As in any high speed analog circuitry, the power supply pins are vulnerable to random noise. The ICS840051 provides separate power supplies to isolate any high switching noise from the outputs to the internal PLL.  $V_{DD}$  and  $V_{DDA}$  should be individually connected to the power supply plane through vias, and bypass capacitors should be used for each pin. To achieve optimum jitter performance, power supply isolation is required. *Figure 1* illustrates how a  $10\Omega$  resistor along with a  $10\mu\text{F}$  and a  $.01\mu\text{F}$  bypass capacitor should be connected to each  $V_{DDA}$  pin.

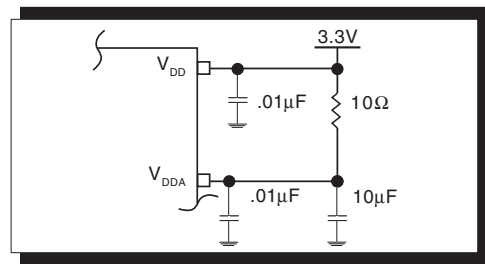

FIGURE 1. POWER SUPPLY FILTERING

### CRYSTAL INPUT INTERFACE

The ICS840051 has been characterized with 18pF parallel resonant crystals. The capacitor values, C1 and C2, shown in *Figure 2* below were determined using an 18pF parallel reso-

nant crystal and were chosen to minimize the ppm error. The optimum C1 and C2 values can be slightly adjusted for different board layouts.

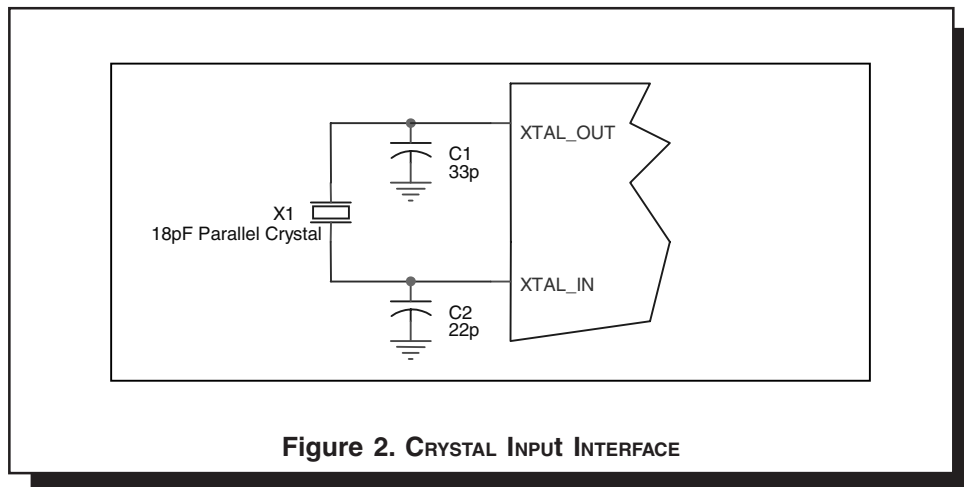
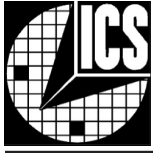

Figure 2. CRYSTAL INPUT INTERFACE



Integrated  
Circuit  
Systems, Inc.

**ICS840051**  
FEMTOCLOCKS™ CRYSTAL-TO-  
LVCMOS/LVTTL CLOCK GENERATOR

## RELIABILITY INFORMATION

TABLE 7.  $\theta_{JA}$  VS. AIR FLOW TABLE FOR 8 LEAD TSSOP

$\theta_{JA}$ by Velocity (Meters per Second)			
	0	1	2.5
Multi-Layer PCB, JEDEC Standard Test Boards	101.7°C/W	90.5°C/W	89.8°C/W

### TRANSISTOR COUNT

The transistor count for ICS840051 is: 1927





Integrated  
Circuit  
Systems, Inc.

# ICS840051

FEMTOCLOCKS™ CRYSTAL-TO-  
LVCMOS/LVTTL CLOCK GENERATOR

## PACKAGE OUTLINE - G SUFFIX FOR 8 LEAD TSSOP

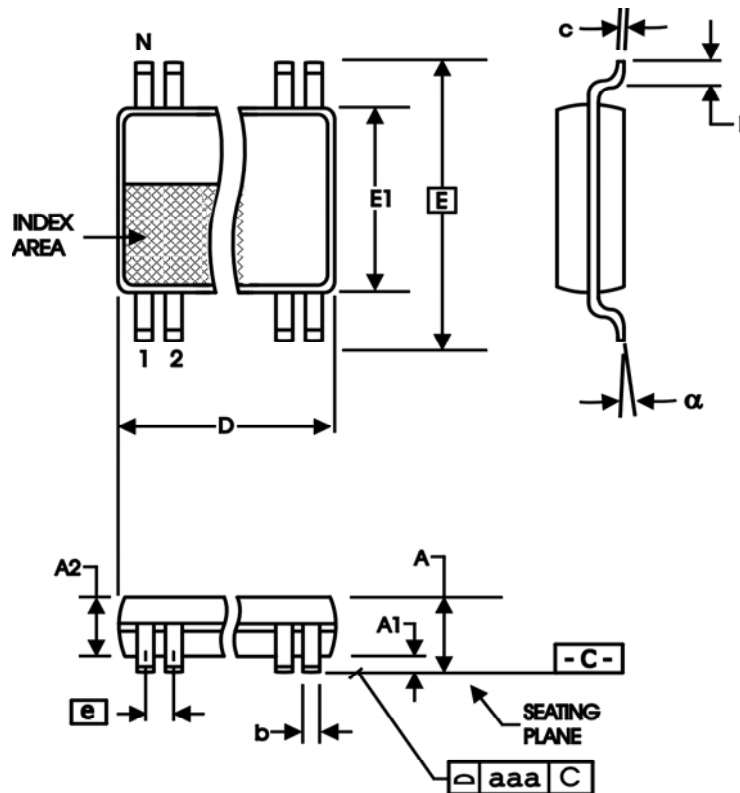
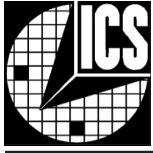

TABLE 8. PACKAGE DIMENSIONS

SYMBOL	Millimeters	
	Minimum	Maximum
N	8	
A	--	1.20
A1	0.05	0.15
A2	0.80	1.05
b	0.19	0.30
c	0.09	0.20
D	2.90	3.10
E	6.40 BASIC	
E1	4.30	4.50
e	0.65 BASIC	
L	0.45	0.75
alpha	0°	8°
aaa	--	0.10

Reference Document: JEDEC Publication 95, MO-153



Integrated  
Circuit  
Systems, Inc.

# ICS840051

## FEMTOCLOCKS™ CRYSTAL-TO- LVCMOS/LVTTL CLOCK GENERATOR

**TABLE 9. ORDERING INFORMATION**

Part/Order Number	Marking	Package	Shipping Packaging	Temperature
ICS840051AG	0051A	8 Lead TSSOP	tube	0°C to 70°C
ICS840051AGT	0051A	8 Lead TSSOP	2500 tape & reel	0°C to 70°C
ICS840051AGLF	051AL	8 Lead "Lead-Free" TSSOP	tube	0°C to 70°C
ICS840051AGLFT	051AL	8 Lead "Lead-Free" TSSOP	2500 tape & reel	0°C to 70°C

The aforementioned trademarks, HiPerClockS™ and FemtoClocks™ are a trademark of Integrated Circuit Systems, Inc. or its subsidiaries in the United States and/or other countries. While the information presented herein has been checked for both accuracy and reliability, Integrated Circuit Systems, Incorporated (ICS) assumes no responsibility for either its use or for infringement of any patents or other rights of third parties, which would result from its use. No other circuits, patents, or licenses are implied. This product is intended for use in normal commercial applications. Any other applications such as those requiring extended temperature range, high reliability, or other extraordinary environmental requirements are not recommended without additional processing by ICS. ICS reserves the right to change any circuitry or specifications without notice. ICS does not authorize or warrant any ICS product for use in life support devices or critical medical instruments.