

GP1A50HR/GP1A51HR GP1A52HR/GP1A53HR

OPIC Photointerrupter

■ Features

1. High sensing accuracy (Slit width : 0.5mm)
2. LSTTL and TTL compatible output
3. Both-sides mounting type : **GP1A50HR** (Gap: 3mm)
Either-side mounting type : **GP1A51HR** (Gap: 3mm)
PWB mounting type : **GP1A52HR** (Gap: 3mm)
GP1A53HR (Gap: 5mm)

■ Applications

1. OA equipment, such as printers, facsimiles, etc.
2. VCRs

OPIC (Optical IC) is a trademark of the SHARP Corporation.
An OPIC consists of a light-detecting element and signal-processing circuit integrated onto a single chip.

■ Outline Dimensions

(Unit : mm)

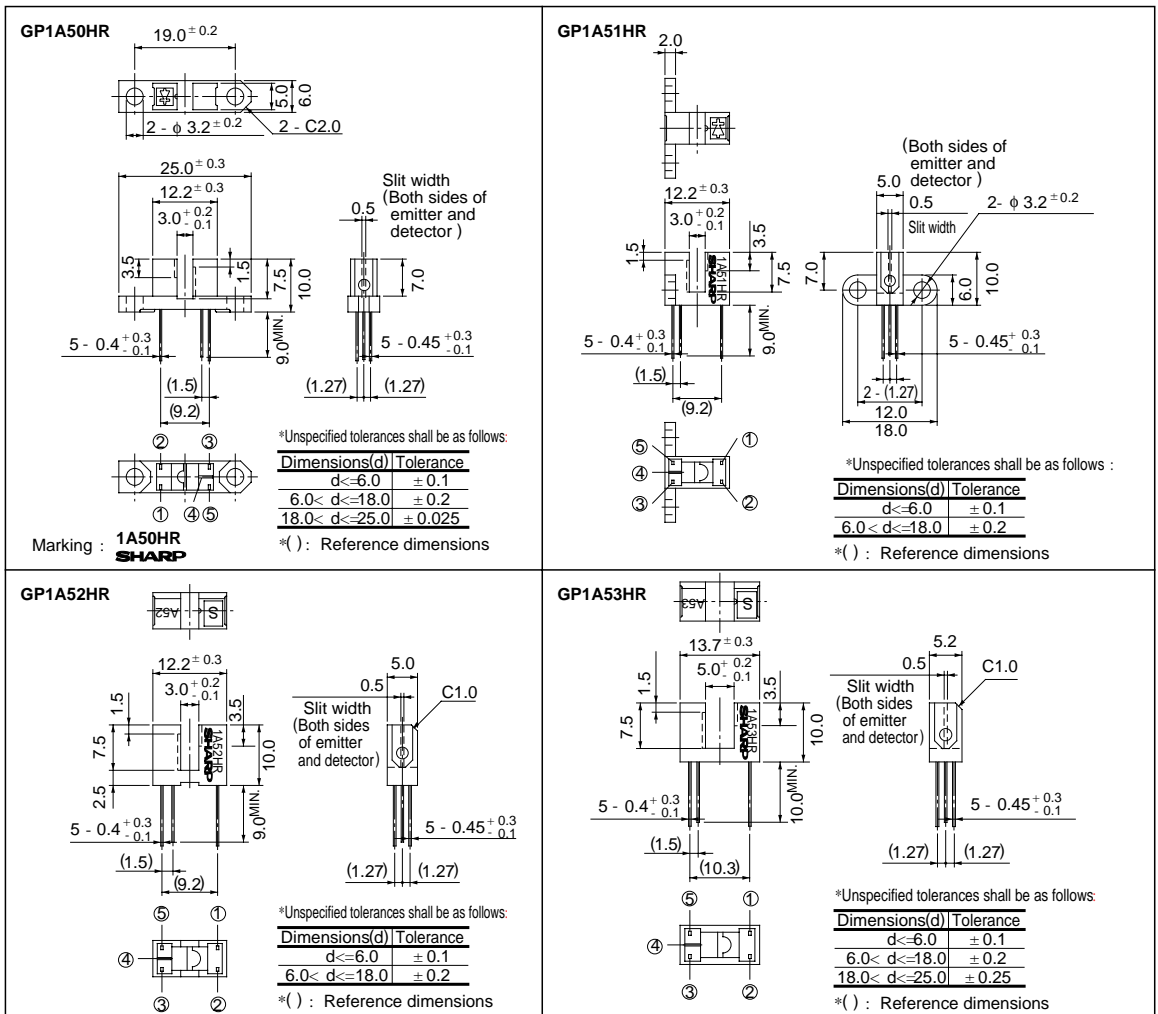

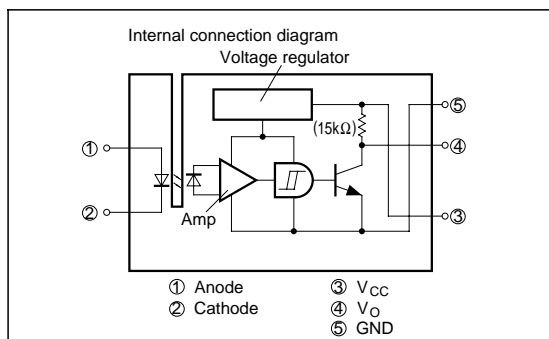

Absolute Maximum Ratings

(T_a = 25°C)

	Parameter	Symbol	Rating	Unit
Input	Forward current	I _F	50	mA
	*1 Peak forward current	I _{FM}	1	A
	Reverse voltage	V _R	6	V
	Power dissipation	P	75	mW
Output	Supply voltage	V _{CC}	- 0.5 to + 17	V
	Output current	I _O	50	mA
	Power dissipation	P _O	250	mW
Operating temperature		T _{opr}	- 25 to + 85	°C
Storage temperature		T _{sg}	- 40 to + 100	°C
*2 Soldering temperature		T _{sol}	260	°C

*1 Pulse width <= 100 μs, Duty ratio = 0.01

*2 For 5 seconds

Electro-optical Characteristics

(T_a = 25°C)

Parameter		Symbol	Conditions	MIN.	TYP.	MAX.	Unit	
Input	Forward voltage	GP1A50HR/GP1A51HR GP1A52HR	V _F I _F = 5mA	-	1.1	1.4	V	
		GP1A53HR	V _F I _F = 8mA	-	1.14	1.4	V	
	Reverse current	I _R	V _R = 3V	-	-	10.0	μA	
Output	Operating supply voltage	V _{CC}		4.5	-	17.0	V	
	Low level output voltage	V _{OL}	V _{CC} = 5V, I _F = 0, I _{OL} = 16mA	-	0.15	0.4	V	
	High level output voltage	V _{OH}	V _{CC} = 5V, *5 I _F = 5mA	4.9	-	-	V	
	Low level supply current	I _{CCL}	V _{CC} = 5V, I _F = 0	-	1.7	3.8	mA	
	High level supply current	I _{CCH}	V _{CC} = 5V, *5 I _F = 5mA	-	0.7	2.2	mA	
Transfer characteristics	*3 "Low→High" threshold input current	GP1A50HR/GP1A51HR GP1A52HR	I _{FLH} V _{CC} = 5V	-	1.0	5.0	mA	
		GP1A53HR	I _{FLH} V _{CC} = 5V	-	1.5	8.0	mA	
	*4 Hysteresis	I _{FHL} / I _{FLH}	V _{CC} = 5V	0.55	0.75	0.95		
	Response time	"Low→High" propagation delay time	t _{PLH}	V _{CC} = 5V, *5 I _F = 5mA R _L = 280Ω	-	3.0	9.0	μs
		"High→Low" propagation delay time	t _{PHL}		-	5.0	15.0	
		Rise time	t _r		-	0.1	0.5	
Fall time		t _f	-		0.05	0.5		

*3 I_{FLH} represents forward current when output changes from low to high.*4 I_{FHL} represents forward current when output changes from high to low. Hysteresis stands for I_{FHL} / I_{FLH}.*5 GP1A53HR Condition of V_{OH}, I_{CCH}, Response time; I_F = 8mA

■ Recommended Operating Conditions

Parameter	Symbol	Operating temp.	MIN.	MAX.	Unit
Low level output current	I_{OL}	$T_a = 0 \text{ to } +70^\circ\text{C}$	-	16.0	mA
Forward current	I_F		10.0	20.0	mA

Fig. 1 Forward Current vs. Ambient Temperature

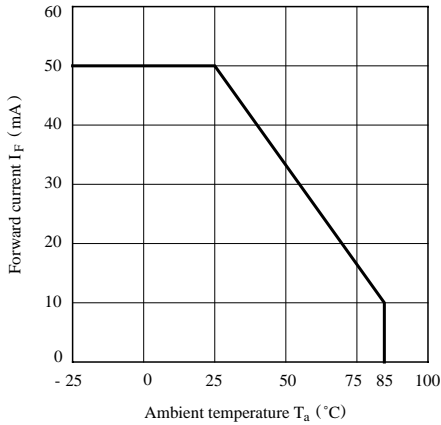

Fig. 2 Output Power Dissipation vs. Ambient Temperature

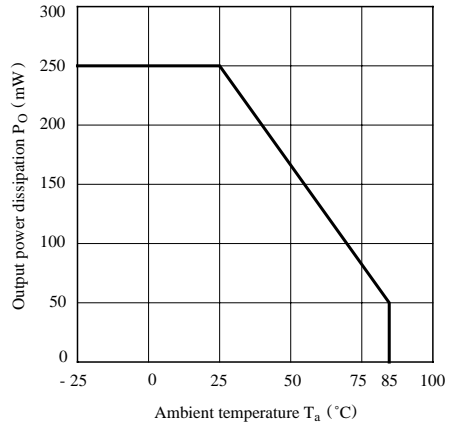

Fig. 3 Low Level Output Current vs. Ambient Temperature

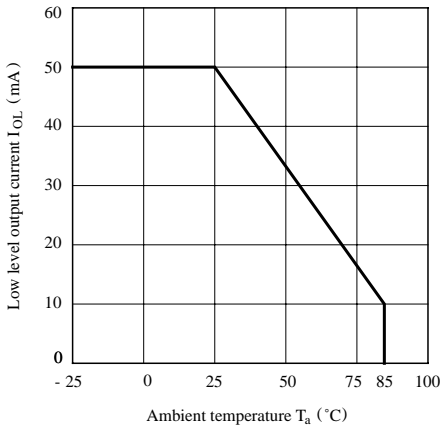

Fig. 4 Forward Current vs. Forward Voltage

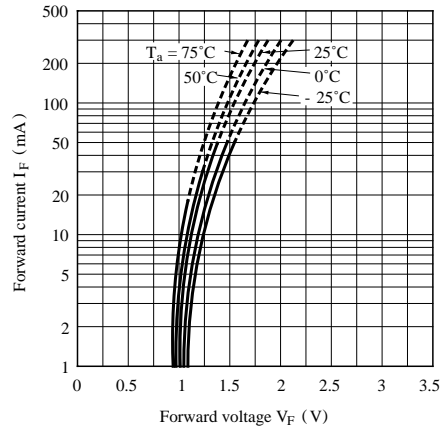

Fig. 5 Relative Threshold Input Current vs. Supply Voltage

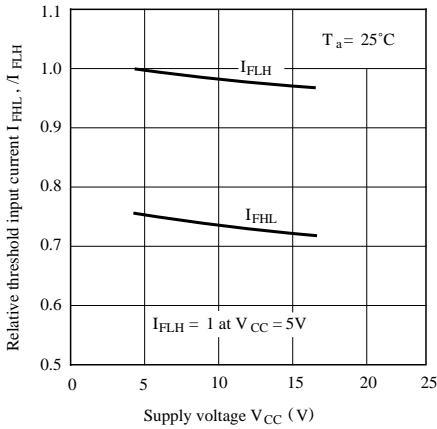

Fig. 6 Relative Threshold Input Current vs. Ambient Temperature

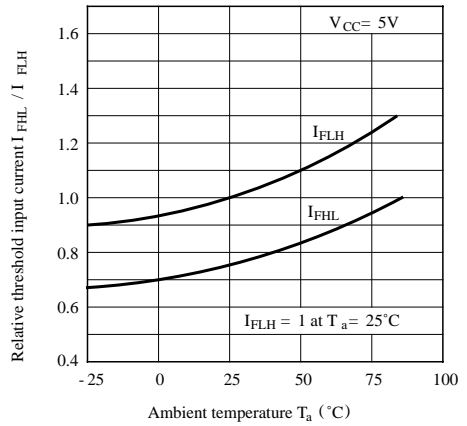

Fig. 7 Low Level Output Voltage vs. Low Level Output Current

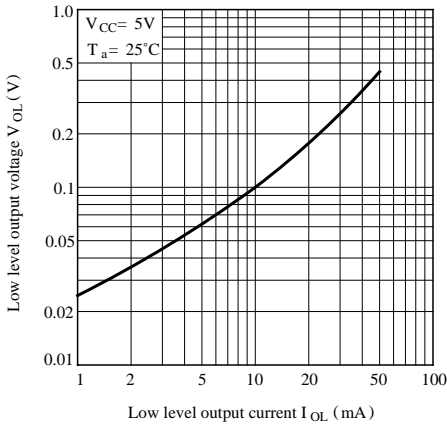

Fig. 8 Low Level Output Voltage vs. Ambient Temperature

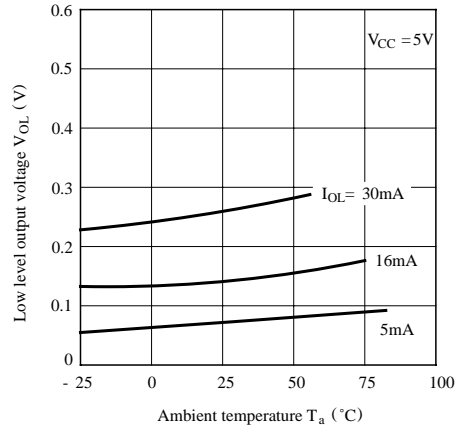

Fig. 9 Supply Current vs. Ambient Temperature

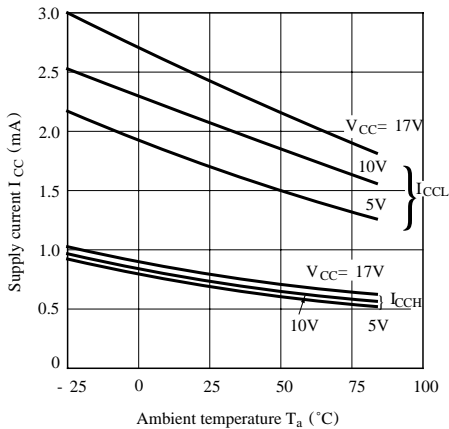

Fig.10-a Propagation Delay Time vs. Forward Current (GP1A50HR/GP1A51HR/GP1A52HR)

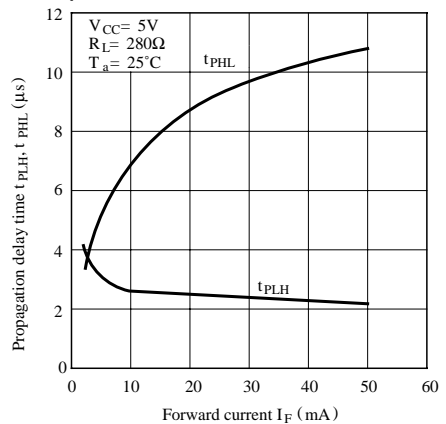

Fig.10-b Propagation Delay Time vs. Forward Current

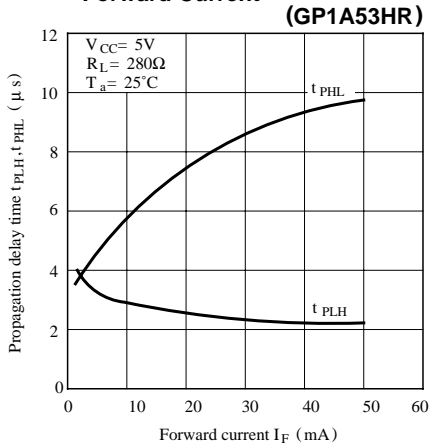
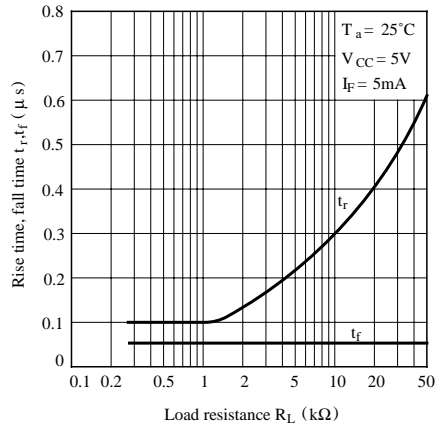
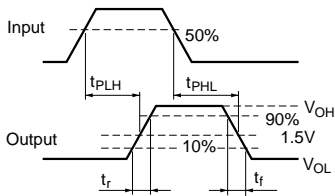
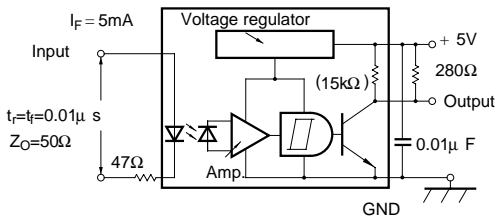

Fig.12 Rise Time, Fall Time vs. Load Resistance



Test Circuit for Response Time



■ Precautions for Use

- (1) In order to stabilize power supply line, connect a by-pass capacitor of more than 0.01 μF between V_{CC} and GND near the device.
- (2) In case of cleaning, use only the following type of cleaning solvent.
Ethyl alcohol, Methyl alcohol, Isopropyl alcohol
- (3) As for other general cautions refer to the chapter "Precautions for Use".