

# GP2S30

## Long Focal Distance Type Photointerrupter with Connector

### ■ Features

1. Long focal distance  
Detection distance: 3 to 7mm
2. High sensing accuracy by laser  
trimming of resistor
3. 3-pin connector

### ■ Applications

1. Printers
2. Facsimiles
3. Copiers

### ■ Outline Dimensions

(Unit : mm)

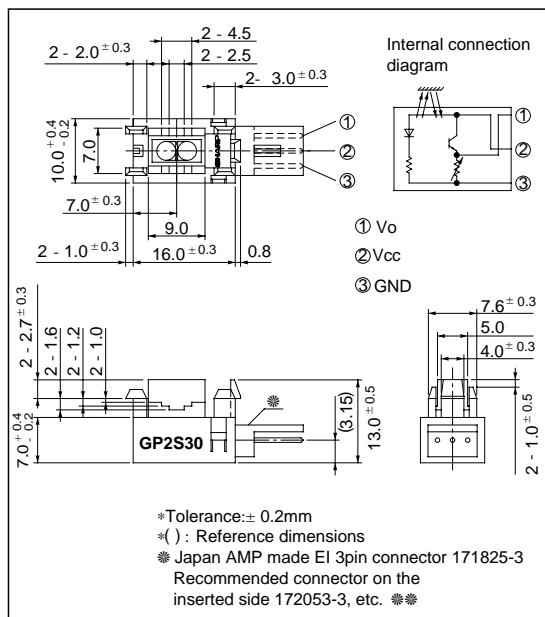

\* \* \* Recommended connectors on the inserted side are shown on the below page.

### ■ Absolute Maximum Ratings (Ta = 25°C)

Parameter	Symbol	Rating	Unit
Supply voltage	V <sub>CC</sub>	- 0.5 to + 7	V
Output current	I <sub>O</sub>	I	mA
<sup>*1</sup> Operating temperature	T <sub>opr</sub>	- 20 to + 70	°C
<sup>*1</sup> Storage temperature	T <sub>stg</sub>	- 40 to + 80	°C

\*1 The connector should be plugged in/out and the unit's hook should be used at normal temperature.

### ■ Electro-optical Characteristics

(V<sub>CC</sub> = 5V, Ta = 25°C unless otherwise specified)

Parameter	Symbol	Conditions	MIN.	TYP.	MAX.	Unit
Operating supply voltage	V <sub>CC</sub>	Ta = - 20 to + 70°C	4.5	5.0	5.5	V
Dissipation current	I <sub>CC</sub>	<sup>*2</sup> At detecting, d = 5mm	-	26	35	mA
Low level output voltage	V <sub>OL</sub>	<sup>*3</sup> At non-detecting, d = 5mm	-	0.2	0.8	V
High level output voltage	V <sub>OH</sub>	<sup>*2</sup> At detecting, d = 5mm	2.1	3.0	3.9	V
Response frequency	f	<sup>*4</sup>	-	-	170	Hz

\*2 At detecting : White PPC paper as a reflective object without external disturbing light in Fig. 1.

\*3 At non-detecting : Black suede tape as a reflective object without external disturbing light in Fig. 1.

\*4 The definition of response frequency is shown in Fig. 2.

Fig. 1 Test Condition for  $V_O$

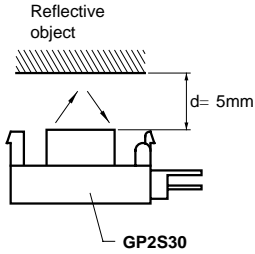
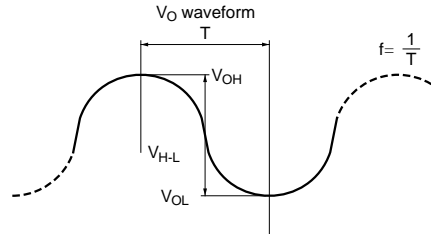
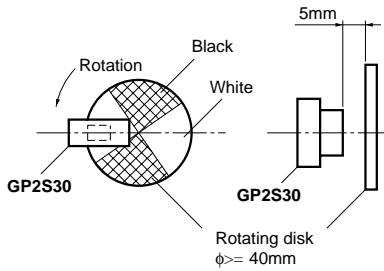

Fig. 2 Definition of Response Frequency



Response frequency: Rotational frequency  $f$  when  $V_{H-L}$  decreases 3dB from DC.

Fig. 3 Relative Output Voltage vs. Ambient Temperature

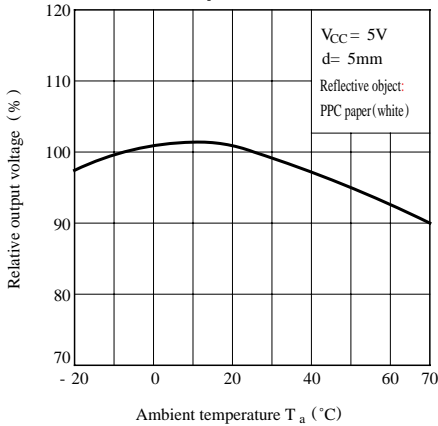
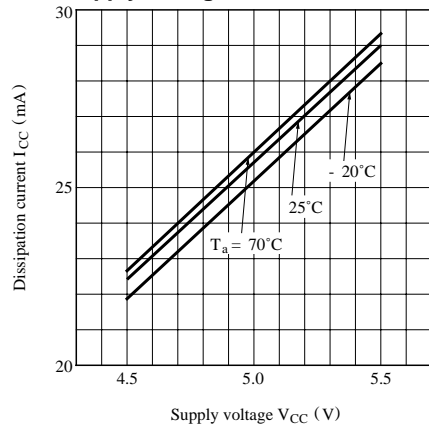
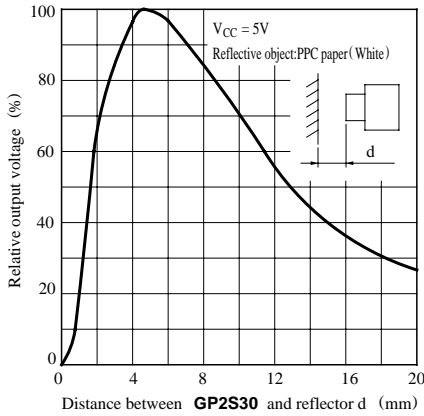

Fig. 4 Dissipation Current vs. Supply Voltage



**Fig. 5 Relative Output Voltage vs. Detecting Distance**



**Fig. 6 Relative Collector Voltage vs. Reflector Moving Distance (1)**

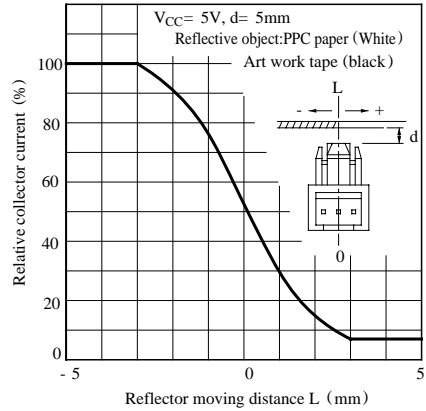

**Fig. 7 Relative Collector Voltage vs. Reflector Moving Distance (2)**

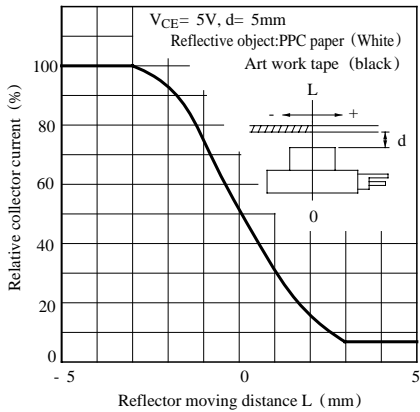

**Recommended Mounting Holes (mm)**

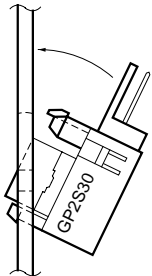

Board thickness  $1.6 \begin{smallmatrix} +0.17 \\ -0.12 \end{smallmatrix} mm$

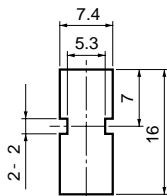

Board thickness  $1.2 \begin{smallmatrix} +0.17 \\ -0.12 \end{smallmatrix} mm$

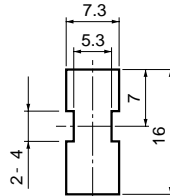

Board thickness  $1.0 \begin{smallmatrix} +0.17 \\ -0.12 \end{smallmatrix} mm$

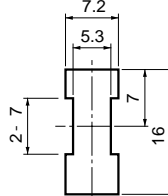

**Mounting Method**

**Recommended Mounting Holes**

## ■ Recommended Connectors on the Inserted Side

### ● JAPAN AMP made EI series connector (standard type)

Housing color	Natural color	Black	Blue	Green	Red
Housing Model No.	171822-3	2-171822-3	4-171822-3	6-171822-3	8-171822-3
Special terminal Model No.	AWG size	Product shape	Material	Model No.	
			Brass	170204-1	
	Chain	phosphor bronze	170204-2		
		Bulk	Brass	170262-1	
	phosphor bronze		170262-2		
	AWG 26 to 20	Chain	Brass	170205-1	
			phosphor bronze	170205-2	
		Bulk	Brass	170263-1	
			phosphor bronze	170263-2	
	AWG 30 to 26	Chain	Brass	170205-1	
Bulk		Brass	170263-1		

### ● JAPAN AMP made EI Series connectors (low profile type)

Housing color	Natural color	Black	Blue	Green	Red
Housing Model No.	172142-3	2-172142-3	4-172142-3	6-172142-3	8-172142-3
Special terminal Model No. (Material: phosphor bronze)	AWG size	Product shape	Model No.		
			Bulk	170369-1	
	26 to 22	Chain	170354-1		
		30 to 26	Bulk	170370-1	
	Chain		170355-1		

### ● JAPAN AMP made EI Series connectors (amp. mass termination)

Housing terminal united type connector	AWG28 (Green)	AWG26 (Natural color)	AWG24 (Black)	AWG22 (Red)
	172054-3	172053-3	172052-3	172051-3

\* Terminal Material: phosphor bronze

## ■ Recommended Circuit

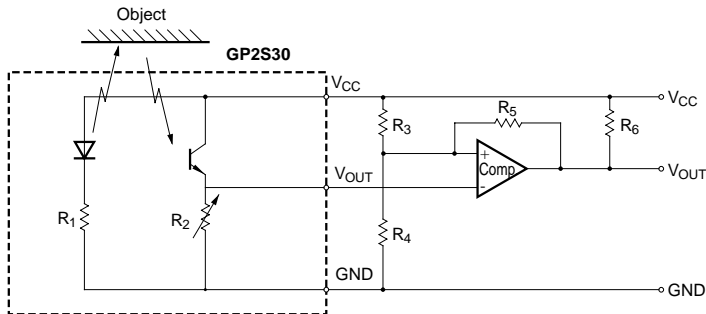

## ■ Precautions for Use

- (1) In this product, the PWB is fixed with a hook, and cleaning solvent may remain inside the case; therefore, dip cleaning or ultrasonic are prohibited.
- (2) Remove dust or stains, using an air blower or a soft cloth moistened in cleaning solvent. However, do not perform the above cleaning using a soft cloth with cleaning solvent in the marking portion.

In this case, use only the following type of cleaning solvent used for wiping off:

Ethyl alcohol, Methyl alcohol, Isopropyl alcohol,

When the cleaning solvents except for specified materials are used, please consult us.

- (3) As for other general cautions, refer to the chapter "Precautions for Use".