



**BIPOLAR ANALOG INTEGRATED CIRCUIT**  
 **$\mu$ PC3205GR**

**IQ DEMODULATOR FOR DIGITAL VIDEO/DATA RECEIVER**

**DESCRIPTION**

The  $\mu$ PC3205GR is Silicon monolithic IC designed for use as IQ demodulator in digital communication systems. This IC consists of AGC amplifier, dual balanced mixers (DBM), oscillator, quadrature phase shifter and I & Q output buffer amplifiers.

The package is 20-pin SSOP (shrink small outline package) suitable for high-density surface mount.

**FEATURES**

- On chip quadrature (90°) phase shifter
- IQ phase and amplitude balance
 

Amplitude Balance :	$\pm 0.5$ dB
Phase Balance :	$\pm 2.0$ degree
- Low distortion
 

IM <sub>3</sub> :	56 dBc (@0.708 V <sub>P-P</sub> /tone)
-------------------	--
- Supply Voltage
 

V <sub>CC</sub> :	5 V
-------------------	-----
- Packaged in 20-pin SSOP suitable for high-density surface mount

**ORDERING INFORMATION**

Part Number	Package	Supplying Form
$\mu$ PC3205GR-E1	20-pin plastic SSOP (225 mil)	Embossed tape 12 mm wide. Pin 1 indicates pull-out direction of tape. Q'ty 2.5 k/reel

For evaluation sample order, please contact your local NEC office. (Part number for sample order:  $\mu$ PC3205GR)

**Caution electro-static sensitive device**

The information in this document is subject to change without notice. Before using this document, please confirm that this is the latest version.  
 Not all devices/types available in every country. Please check with local NEC representative for availability and additional information.

INTERNAL BLOCK DIAGRAM AND PIN CONFIGURATION (Top View)

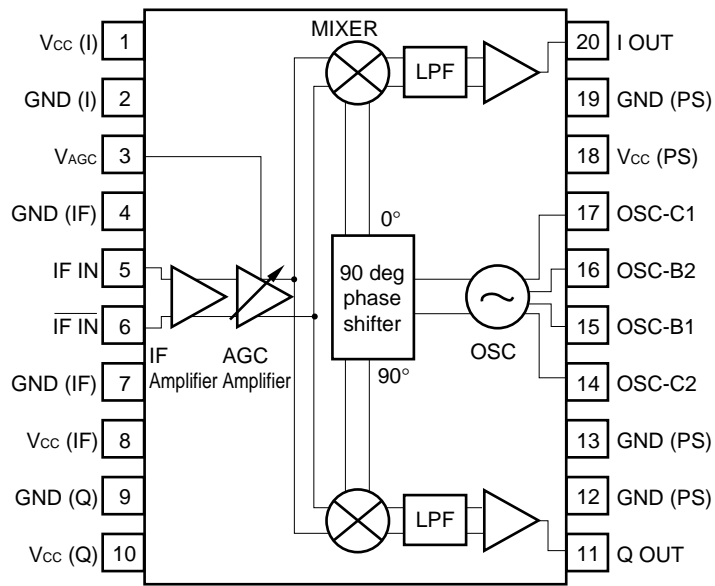

**PIN FUNCTIONS**

Pin No.	Pin Name	Pin Voltage TYP. (V)	Function and Explanation	Equivalent Circuit
1	V <sub>CC(I)</sub>	5.0	Supply voltage pin.	
2	GND(I)	0.0	Ground pin.	
3	V <sub>AGC</sub>	0 to 5	Gain control pin. V <sub>AGC</sub> = 0 V: Full gain V <sub>AGC</sub> = 5 V: Full reduction	
4	GND(IF)	0.0	Ground pin.	
5	IF IN	2.7	IF input pins. In case of single input, 5 pin or 6 pin should be grounded through capacitor.	
6	$\overline{\text{IF IN}}$	2.7		
7	GND(IF)	0.0	Ground pin.	
8	V <sub>CC(IF)</sub>	5.0	Supply voltage pin.	
9	GND (Q)	0.0	Ground pin.	
10	V <sub>CC (Q)</sub>	5.0	Supply voltage pin.	

Pin No.	Pin Name	Pin Voltage TYP. (V)	Function and Explanation	Equivalent Circuit
11	Q OUT	2.6	Q-signal output pin.	
12	GND(PS)	0.0	Ground pin.	
13	GND(PS)	0.0	Ground pin.	
14	OSC-C2	3.4	Connected capacitor between 14 pin and 15 pin to oscillate with active feedback loop.	
15	OSC-B1	3.0	Connected SAW resonator through capacitor.	
16	OSC-B2	3.0	Connected SAW resonator through capacitor.	
17	OSC-C1	3.4	Connected capacitor between 16 pin and 17 pin to oscillate with active feedback loop.	
18	Vcc(PS)	5.0	Supply voltage pin.	
19	GND(PS)	0.0	Ground pin.	
20	I OUT	2.6	I-signal output pin.	

**ABSOLUTE MAXIMUM RATINGS (T<sub>A</sub> = +25°C unless otherwise specified)**

Parameter	Symbol	Test Condition	Rating	Unit
Supply Voltage	V <sub>CC</sub>		6.0	V
Power Dissipation	P <sub>D</sub>	T <sub>A</sub> = +85°C <sup>Note</sup>	433	mW
Operating Ambient Temperature	T <sub>A</sub>		-40 to +85	°C
Storage Temperature	T <sub>stg</sub>		-55 to +150	°C

**Note** Mounted on 50 mm × 50 mm × 1.6 mm double epoxy glass board.

**RECOMMENDED OPERATING RANGE**

Parameter	Symbol	Test Condition	MIN.	TYP.	MAX.	Unit
Supply Voltage	V <sub>CC</sub>		4.5	5.0	5.5	V
Operating Ambient Temperature	T <sub>A</sub>		-25	+25	+85	°C
IF Input Level Range	P <sub>IF</sub>	V <sub>out</sub> = 1 V <sub>P-P</sub>	-45	-	-25	dBm
Gain Control Voltage Range	V <sub>AGC</sub>		0.0	-	V <sub>CC</sub>	V

**ELECTRICAL CHARACTERISTICS (T<sub>A</sub> = +25°C, V<sub>CC</sub> = 5 V, Z<sub>in</sub> = 50 Ω, Z<sub>out</sub> = 1 kΩ)**

Parameter	Symbol	Test Conditions	MIN.	TYP.	MAX.	Unit
Circuit Current	I <sub>CC</sub>	No input signal	48	65	78	mA
IF Input Frequency	f <sub>IF</sub>	f <sub>IF</sub> > f <sub>OSC</sub> <b>Note</b>	440	-	520	MHz
IQ Output Frequency	f <sub>IQ</sub>	G <sub>CV</sub> (@f <sub>IQ</sub> = 10 MHz) ± 1 dB, V <sub>out</sub> = 1 V <sub>P-P</sub> P <sub>IF</sub> = -45 to -25 dBm <b>Note</b>	0.3	-	30	MHz
Conversion Gain 1	G <sub>CV1</sub>	f <sub>IF</sub> = 490 MHz, f <sub>OSC</sub> = 479.5 MHz V <sub>AGC</sub> = 0 to 0.5 V <b>Note</b>	49	53	-	dB
Conversion Gain 2	G <sub>CV2</sub>	f <sub>IF</sub> = 490 MHz, f <sub>OSC</sub> = 479.5 MHz, V <sub>AGC</sub> = 2 V <b>Note</b>	-	44	-	dB
Conversion Gain 3	G <sub>CV3</sub>	f <sub>IF</sub> = 490 MHz, f <sub>OSC</sub> = 479.5 MHz V <sub>AGC</sub> = 4.5 V to V <sub>CC</sub> <b>Note</b>	-	-	10	dB
AGC Gain Control Range	G <sub>CR</sub>	f <sub>IF</sub> = 490 MHz, f <sub>OSC</sub> = 479.5 MHz V <sub>AGC</sub> = 0.5 to 4.5 V <b>Note</b>	39	-	-	dB
IQ Phase Balance	Δφ	f <sub>IF</sub> = 490 MHz, f <sub>OSC</sub> = 479.5 MHz, V <sub>out</sub> = 1 V <sub>P-P</sub> P <sub>IF</sub> = -45 to -25 dBm <b>Note</b>	-2	0	+2	deg
IQ Amplitude Balance	ΔV	f <sub>IF</sub> = 490 MHz, f <sub>OSC</sub> = 479.5 MHz, V <sub>out</sub> = 1 V <sub>P-P</sub> P <sub>IF</sub> = -45 to -25 dBm <b>Note</b>	-0.5	0	+0.5	dB
Output Voltage	V <sub>out</sub>	f <sub>IQ</sub> = 0.3 to 30 MHz, P <sub>IF</sub> = -45 to -25 dBm <b>Note</b>	-	1.0	-	V <sub>P-P</sub>
Maximum Output Voltage	V <sub>oclip</sub>	V <sub>AGC</sub> = 0 to 0.5 V, P <sub>IF</sub> = -45 to -25 dBm <b>Note</b>	1.8	-	-	V <sub>P-P</sub>

**Note** By measurement circuit 1

**STANDARD CHARACTERISTICS (T<sub>A</sub> = +25 °C, V<sub>CC</sub> = 5 V, Z<sub>in</sub> = 50 Ω, Z<sub>out</sub> = 1 kΩ)**

Parameter	Symbol	Test Conditions	Reference Value	Unit
Noise Figure (DSB)	NF	f <sub>osc</sub> = 479.5 MHz, f <sub>iQ</sub> = 10 MHz, V <sub>AGC</sub> = 0.5 V <b>Note 1</b>	12.5	dB
Third Order Intermodulation Distortion	IM <sub>3</sub>	f <sub>iF1</sub> = 489 MHz, f <sub>iF2</sub> = 490 MHz, f <sub>osc</sub> = 479.5 MHz V <sub>out</sub> = 0.708 V <sub>P-P</sub> /tone <b>Note 2</b>	56	dBc
LO to IF Isolation	Iso(LO-IF)	f = 480 MHz, 15 pin or 16 pin to 5 pin <b>Note 2</b>	50	dB
LO to IQ Isolation	Iso(LO-IQ)	f = 480 MHz 15 pin or 16 pin to 11 pin or 20 pin <b>Note 2</b>	30	dB
I to Q Isolation	Iso(I-Q)	f = 10 MHz, 11 pin to 20 pin <b>Note 2</b>	30	dB
IF Input Impedance	Z <sub>in</sub> (IF)	f <sub>iF</sub> = 480 MHz	138-j45	Ω
IF Input Return Loss	RL(IF)	f <sub>iF</sub> = 480 MHz	6	dB
IQ Output Impedance	Z <sub>o</sub> (IQ)	f <sub>iQ</sub> = 0.3 to 30 MHz	25	Ω

- Notes** 1. By measurement circuit 2  
 2. By measurement circuit 1

TYPICAL CHARACTERISTICS (T<sub>A</sub> = +25°C)

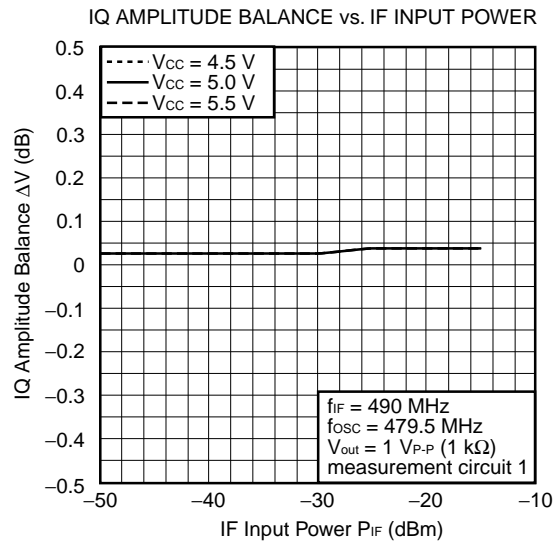
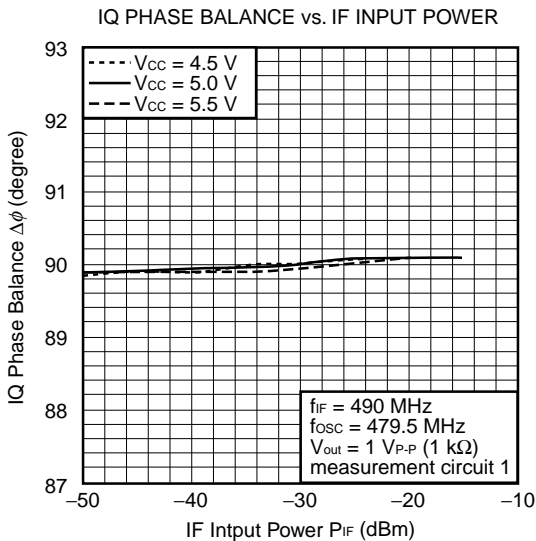
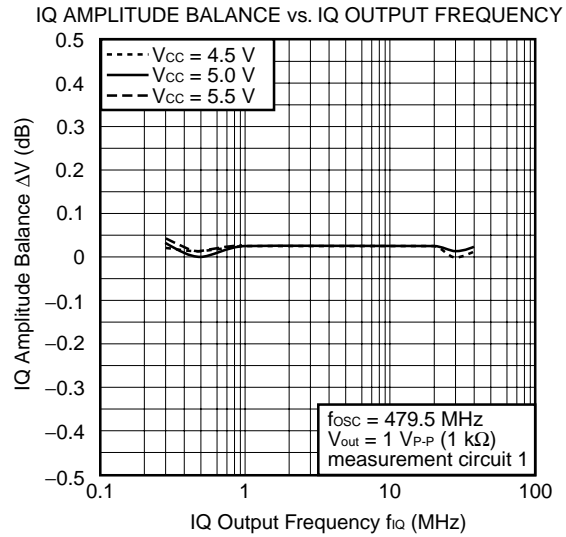
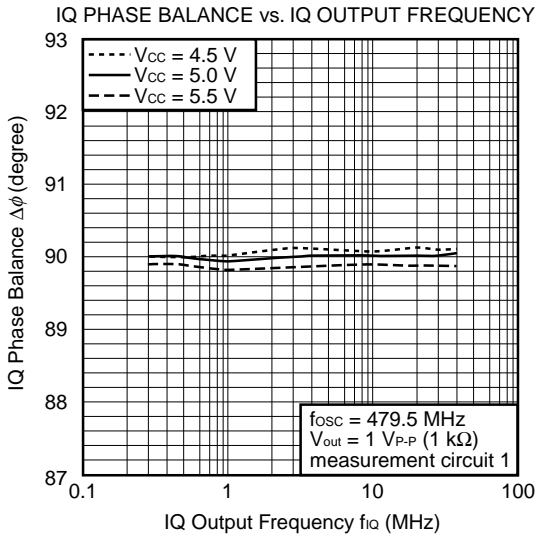
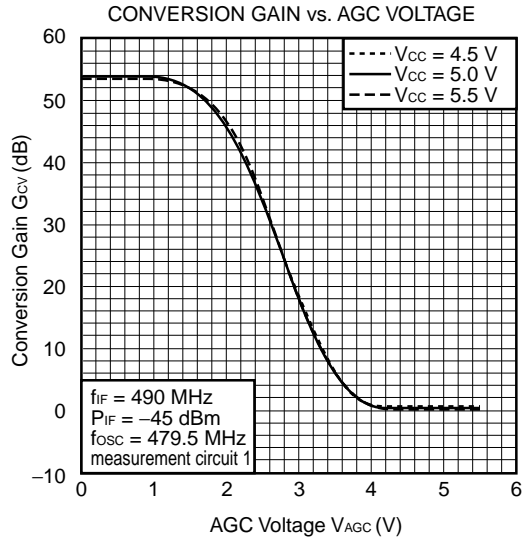
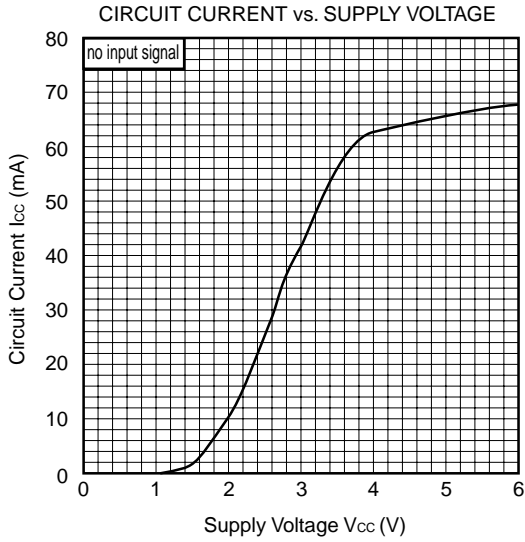

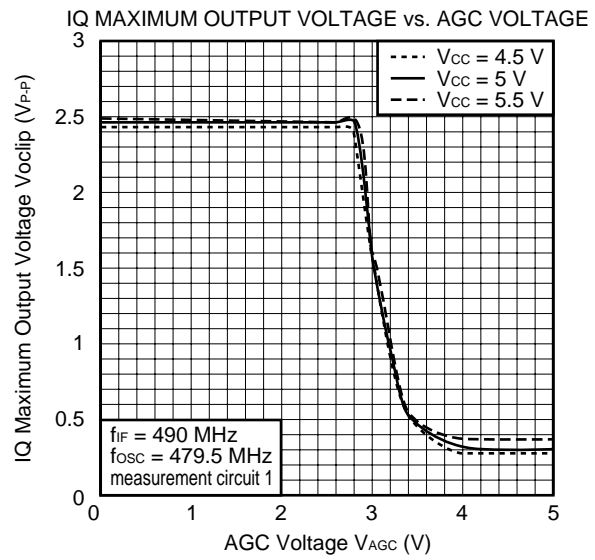
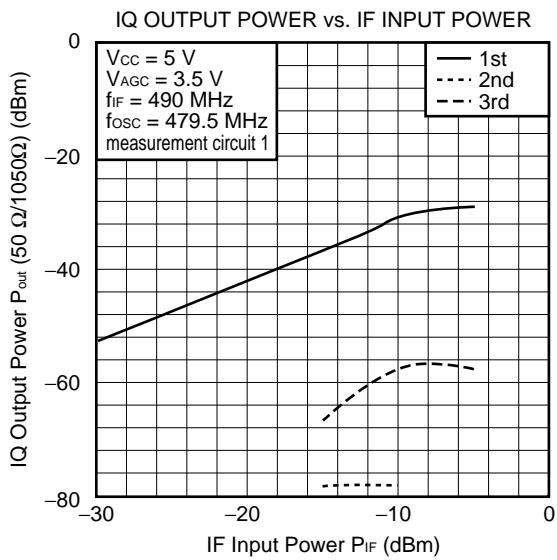
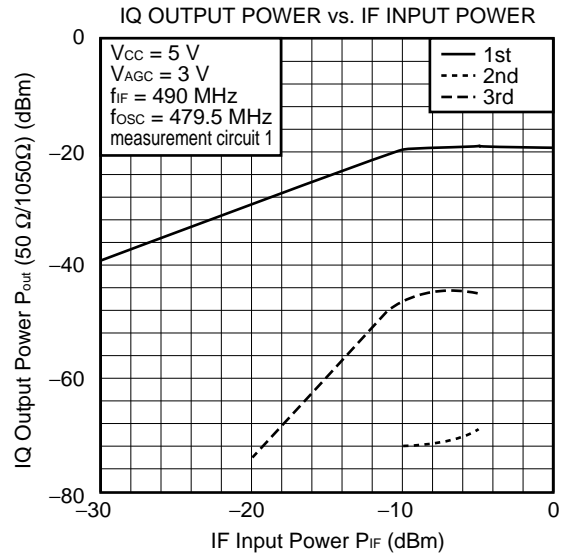
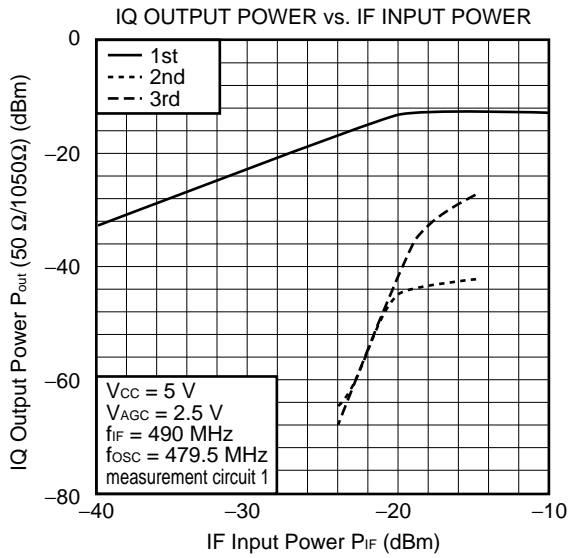
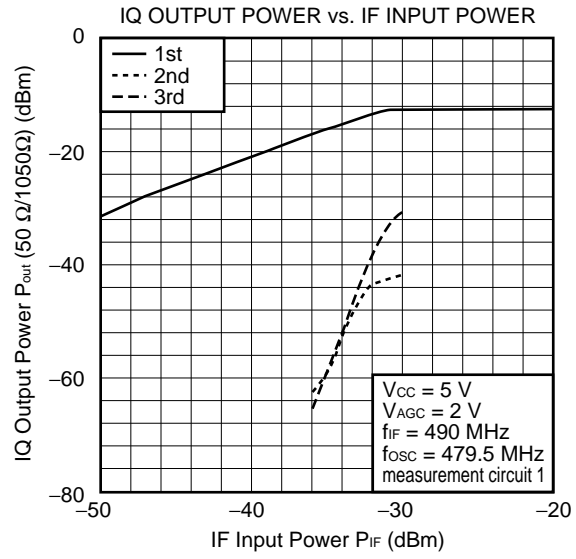
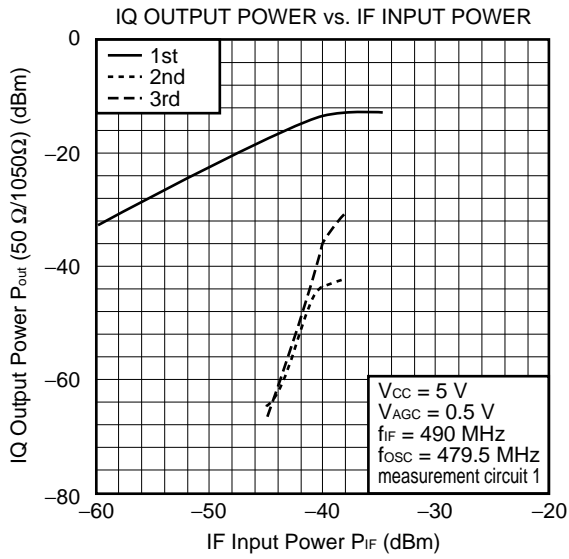



STANDARD CHARACTERISTICS (T<sub>A</sub> = +25°C)

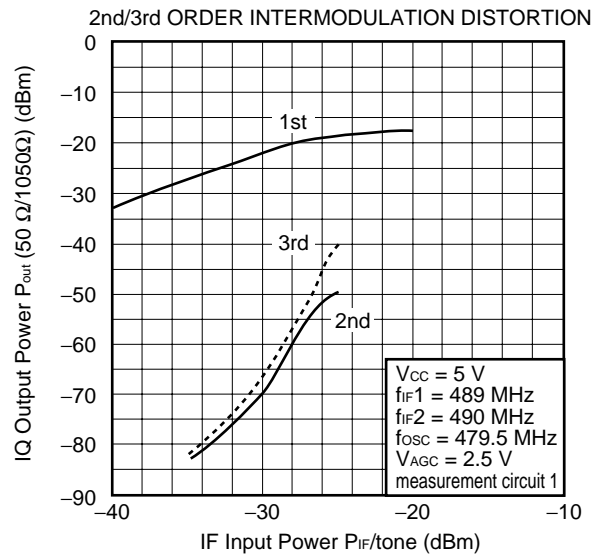
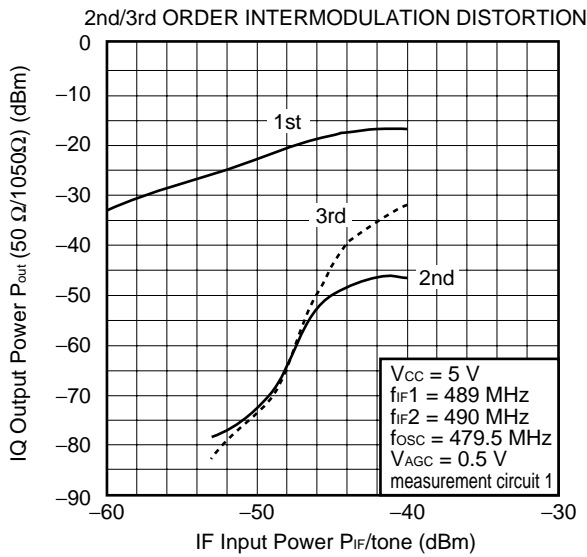
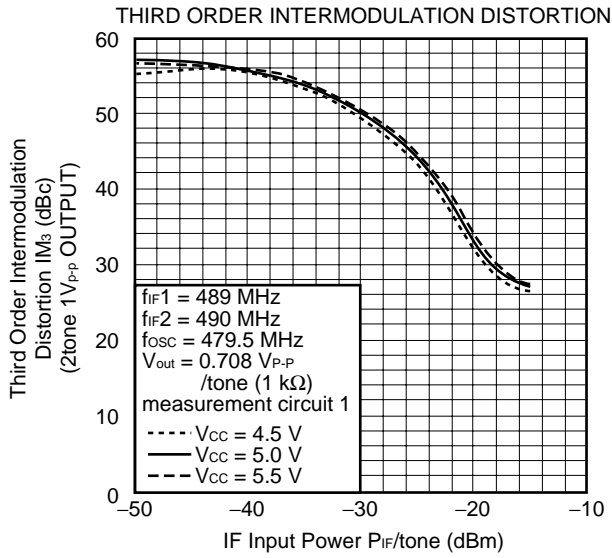

STANDARD CHARACTERISTICS

IF INPUT IMPEDANCE

MARKER 1  
480 MHz  
138.35  $\Omega$  -45.359  $\Omega$

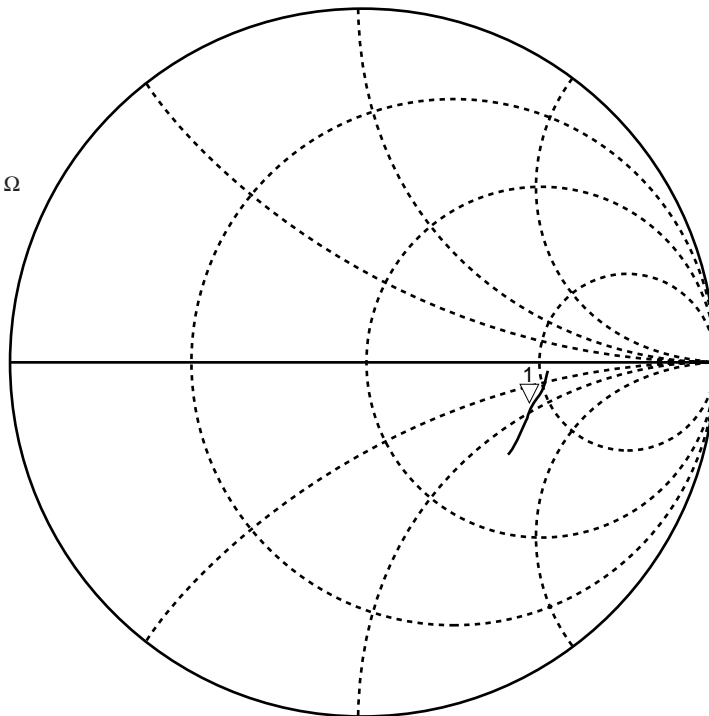

START 10.000 000 MHz

STOP 1000.000 000 MHz

IQ OUTPUT IMPEDANCE

MARKER 1  
10 MHz  
25.26  $\Omega$  1.845  $\Omega$

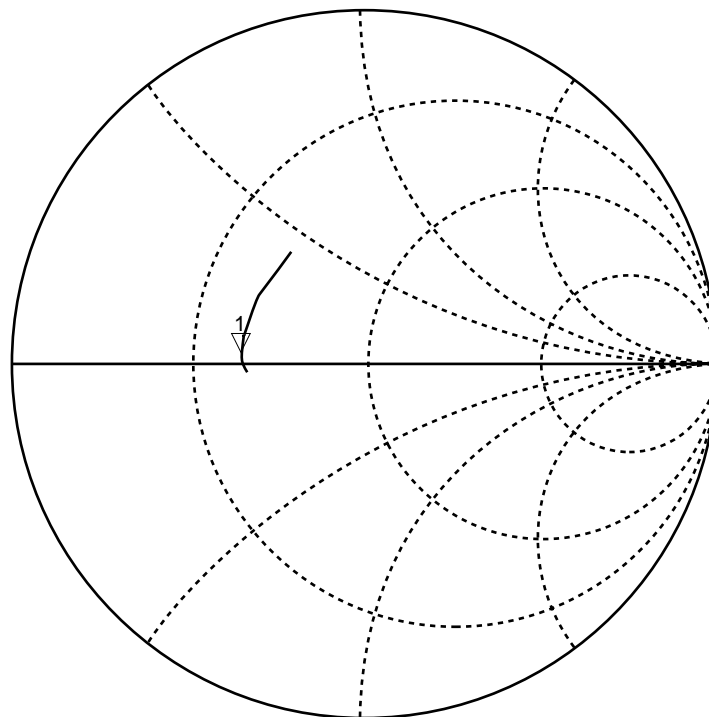

START .300 000 MHz

STOP 100.000 000 MHz

THERMAL CHARACTERISTICS (FOR REFERENCE)

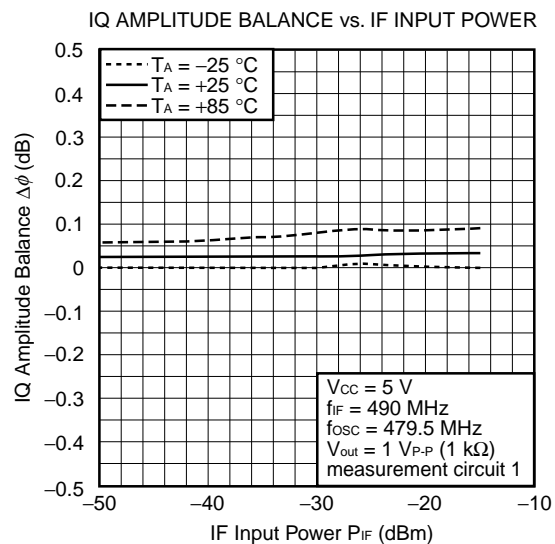
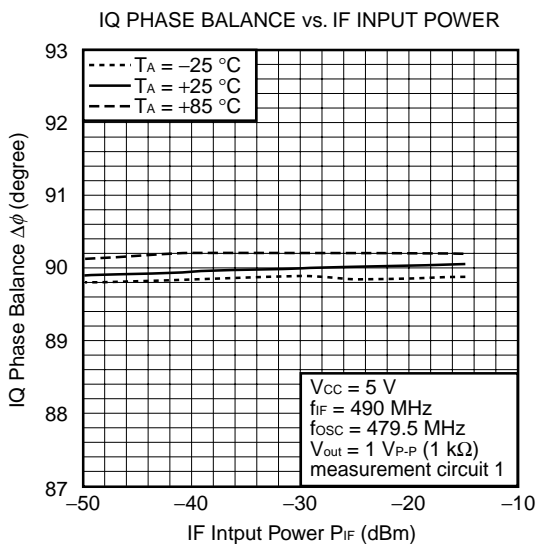
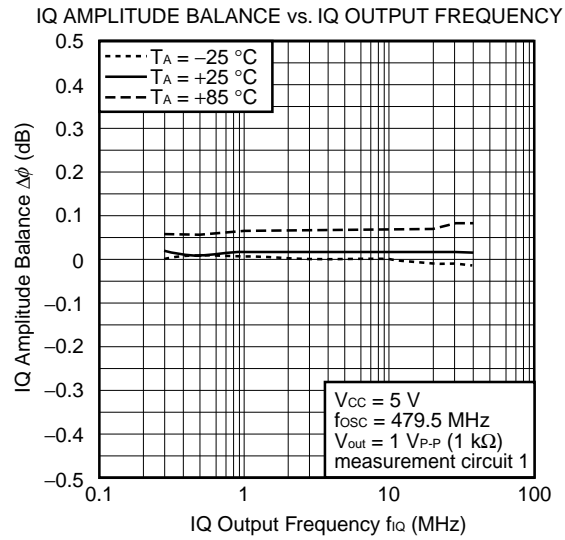
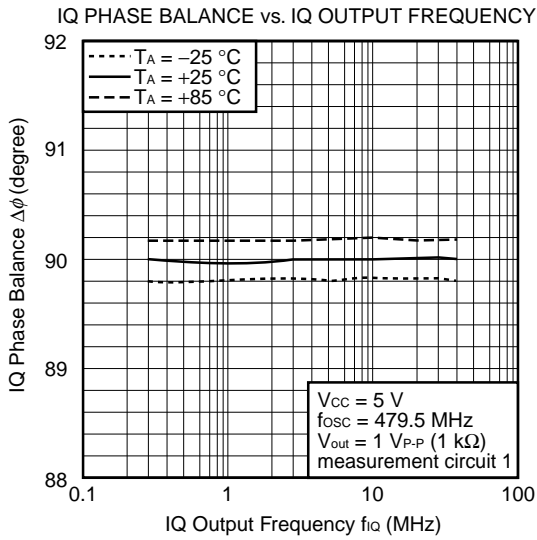
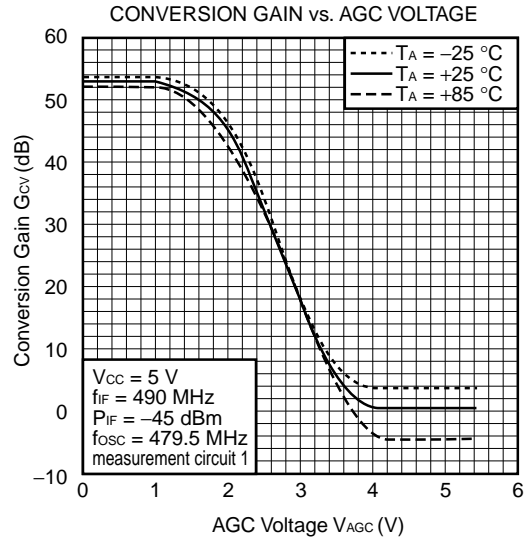
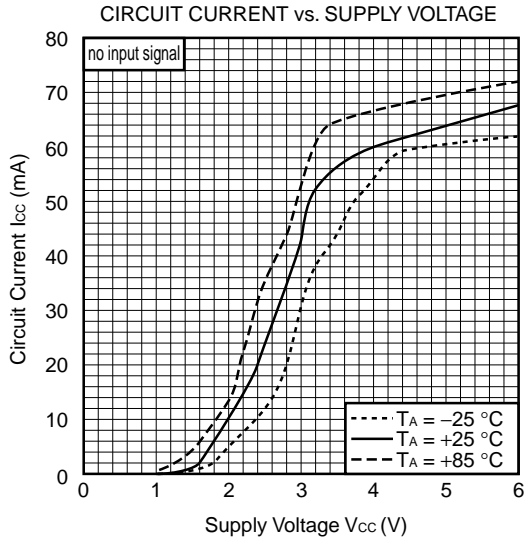

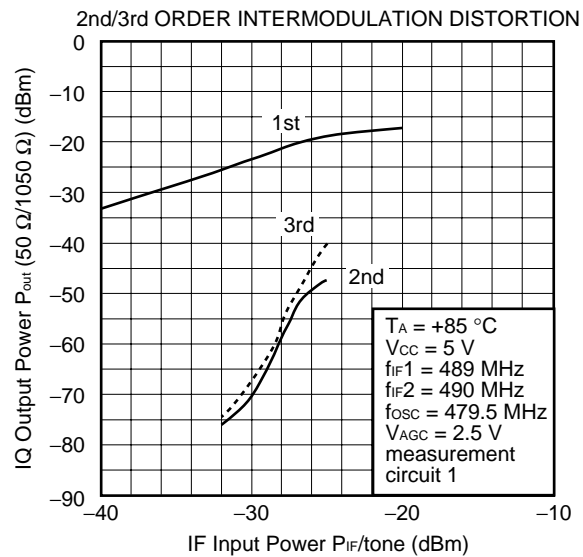
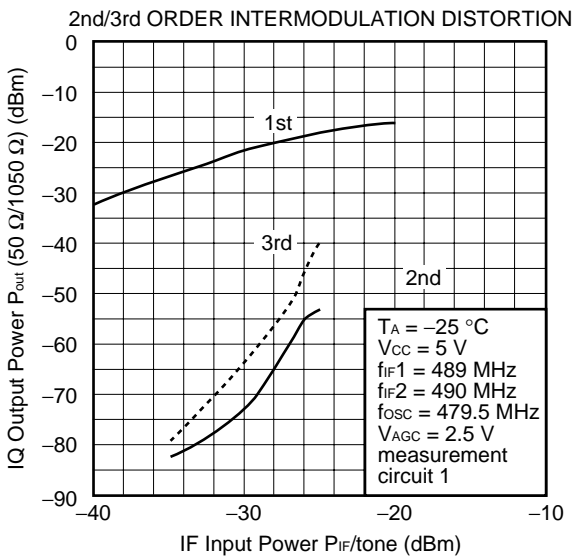
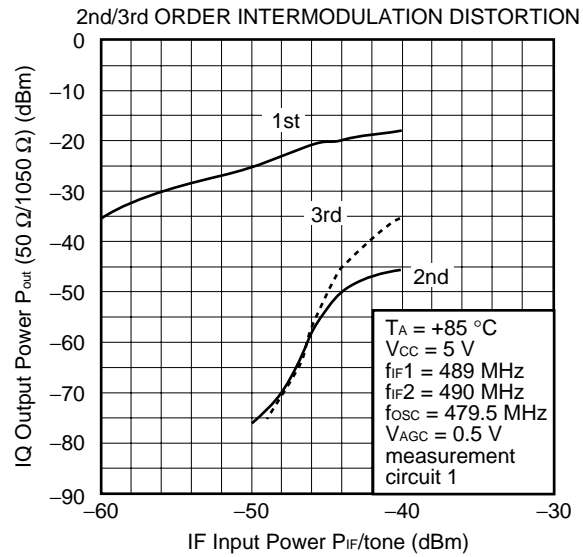
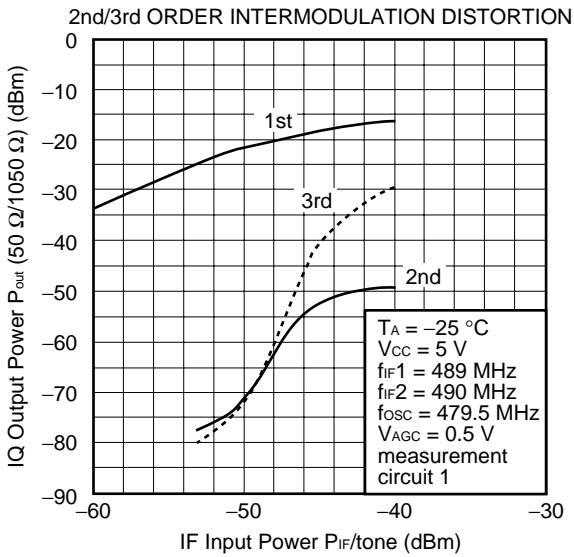
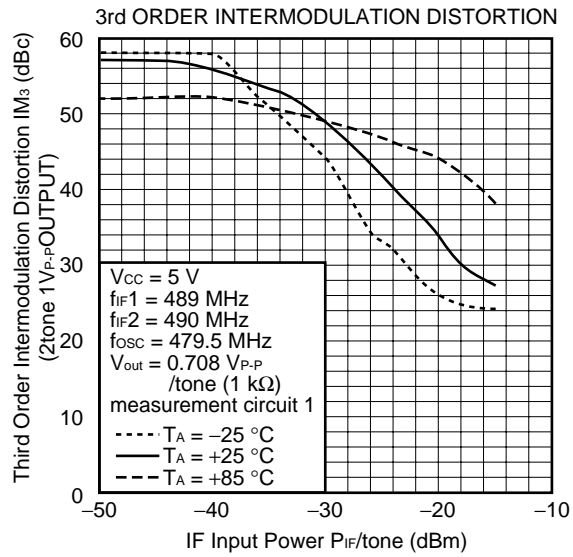
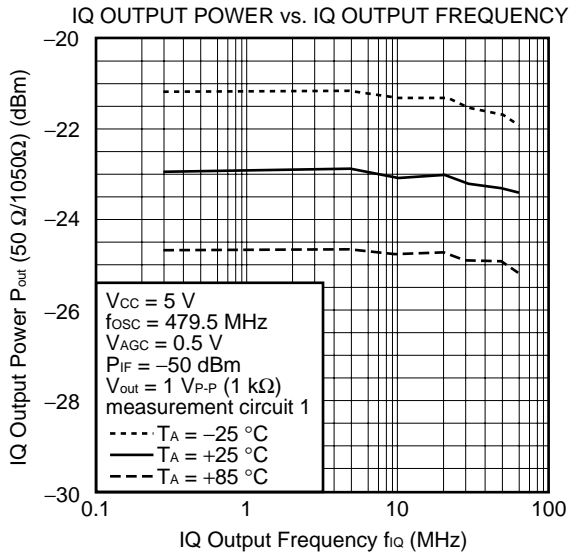

MEASUREMENT CIRCUIT 1

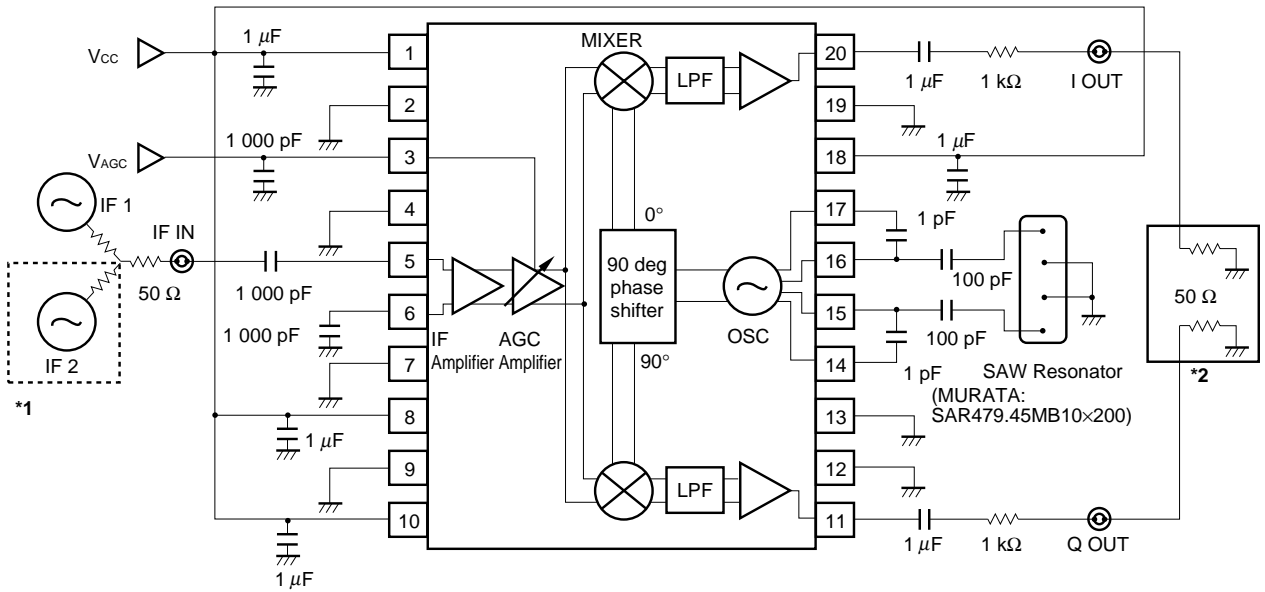

\*1 In the case of measurement of IM<sub>3</sub>.

- \*2 • Vector Signal Analyzer or Vector Voltage Meter @measurement of IQ phase balance and IQ amplitude balance.
- Spectrum Analyzer @measurement of bandwidth and IM<sub>3</sub>.

MEASUREMENT CIRCUIT 2

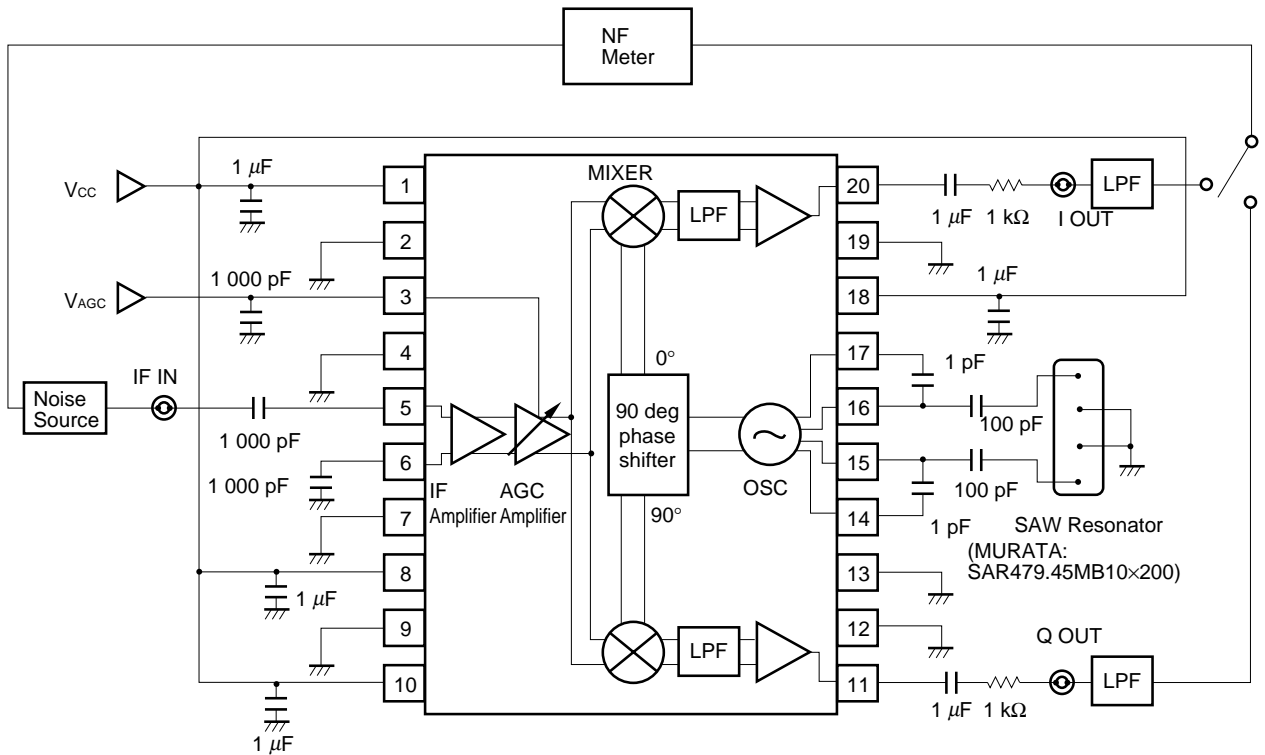

APPLICATION CIRCUIT EXAMPLE (In the case of LO single input)

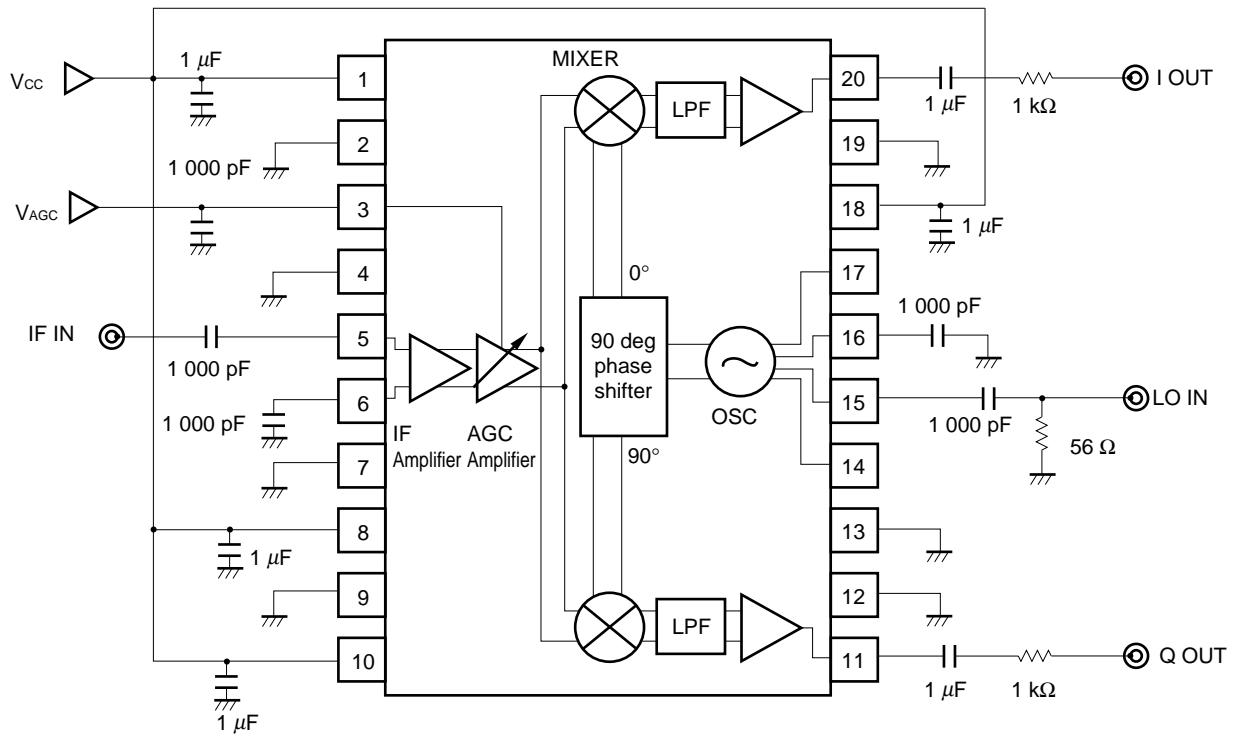

The application circuits and their parameters are for reference only and are not intended for use in actual design-ins.

PACKAGE DIMENSIONS

★ 20 PIN PLASTIC SSOP (225 mil) (UNIT: mm)

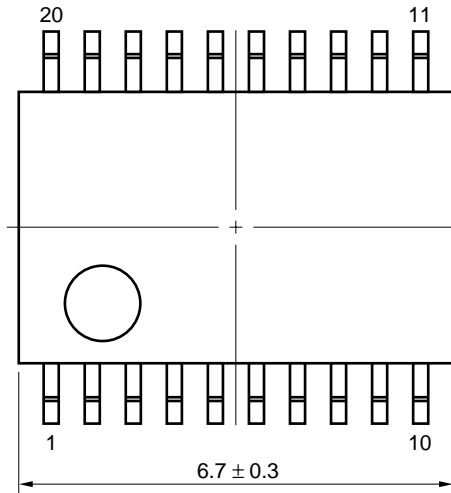

detail of lead end

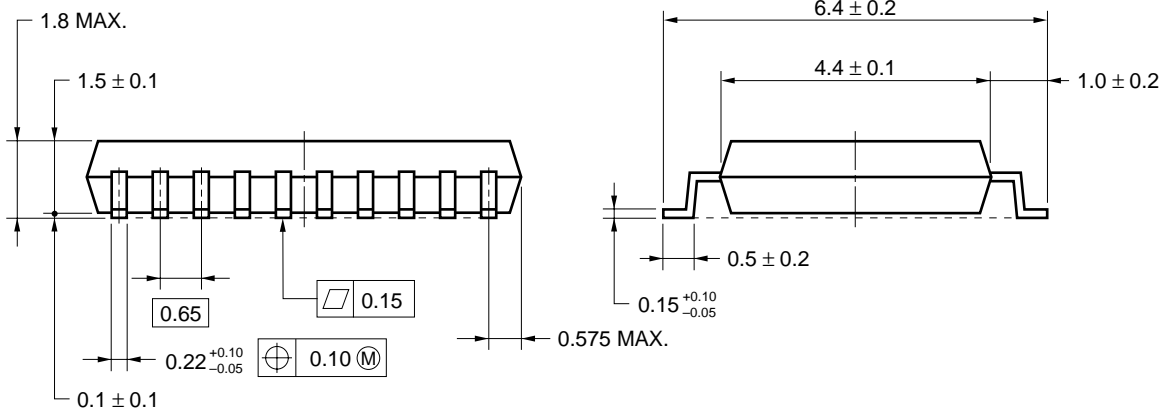
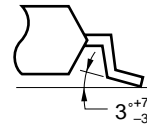

**NOTE** Each lead centerline is located within 0.10 mm of its true position (T.P.) at maximum material condition.

**NOTE ON CORRECT USE**

- (1) Observe precautions for handling because of electro-static sensitive devices.
- (2) Form a ground pattern as widely as possible to minimize ground impedance (to prevent undesires oscillation).
- (3) Keep the track length of the ground pins as short as possible.
- (4) A low pass filter must be attached to V<sub>cc</sub> line.

**RECOMMENDED SOLDERING CONDITIONS**

This product should be soldered under the following recommended conditions. For soldering methods and conditions other than those recommended below, contact your NEC sales representative.

Soldering Method	Soldering Conditions	Recommended Condition Symbol
Infrared Reflow	Package peak temperature: 235 °C or below Time: 30 seconds or less (at 210 °C) Count: 3, Exposure limit <sup>Note</sup> : None	IR35-00-3
VPS	Package peak temperature: 215 °C or below Time: 40 seconds or less (at 200 °C) Count: 3, Exposure limit <sup>Note</sup> : None	VP15-00-3
Wave soldering	Soldering bath temperature: 260 °C or below Time: 10 seconds or less Count: 1, Exposure limit <sup>Note</sup> : None	WS60-00-1
Partial Heating	Pin temperature: 300 °C Time: 3 seconds or less (per side of device) Exposure limit <sup>Note</sup> : None	—

**Note** After opening the dry pack, keep it in a place below 25 °C and 65% RH for the allowable storage period.

**Caution** Do not use different soldering methods together (except for partial heating).

For details of recommended soldering conditions for surface mounting, refer to information document **SEMICONDUCTOR DEVICE MOUNTING TECHNOLOGY MANUAL (C10535E)**.



[MEMO]

[MEMO]

[MEMO]

- **The information in this document is subject to change without notice. Before using this document, please confirm that this is the latest version.**
  - No part of this document may be copied or reproduced in any form or by any means without the prior written consent of NEC Corporation. NEC Corporation assumes no responsibility for any errors which may appear in this document.
  - NEC Corporation does not assume any liability for infringement of patents, copyrights or other intellectual property rights of third parties by or arising from use of a device described herein or any other liability arising from use of such device. No license, either express, implied or otherwise, is granted under any patents, copyrights or other intellectual property rights of NEC Corporation or others.
  - Descriptions of circuits, software, and other related information in this document are provided for illustrative purposes in semiconductor product operation and application examples. The incorporation of these circuits, software, and information in the design of the customer's equipment shall be done under the full responsibility of the customer. NEC Corporation assumes no responsibility for any losses incurred by the customer or third parties arising from the use of these circuits, software, and information.
  - While NEC Corporation has been making continuous effort to enhance the reliability of its semiconductor devices, the possibility of defects cannot be eliminated entirely. To minimize risks of damage or injury to persons or property arising from a defect in an NEC semiconductor device, customers must incorporate sufficient safety measures in its design, such as redundancy, fire-containment, and anti-failure features.
  - NEC devices are classified into the following three quality grades:  
"Standard", "Special", and "Specific". The Specific quality grade applies only to devices developed based on a customer designated "quality assurance program" for a specific application. The recommended applications of a device depend on its quality grade, as indicated below. Customers must check the quality grade of each device before using it in a particular application.
    - Standard: Computers, office equipment, communications equipment, test and measurement equipment, audio and visual equipment, home electronic appliances, machine tools, personal electronic equipment and industrial robots
    - Special: Transportation equipment (automobiles, trains, ships, etc.), traffic control systems, anti-disaster systems, anti-crime systems, safety equipment and medical equipment (not specifically designed for life support)
    - Specific: Aircraft, aerospace equipment, submersible repeaters, nuclear reactor control systems, life support systems or medical equipment for life support, etc.
- The quality grade of NEC devices is "Standard" unless otherwise specified in NEC's Data Sheets or Data Books. If customers intend to use NEC devices for applications other than those specified for Standard quality grade, they should contact an NEC sales representative in advance.