

FAIRCHILD
SEMICONDUCTOR®

PHOTODARLINGTON OPTICAL INTERRUPTER SWITCH

H22B4

H22B5

H22B6

PACKAGE DIMENSIONS

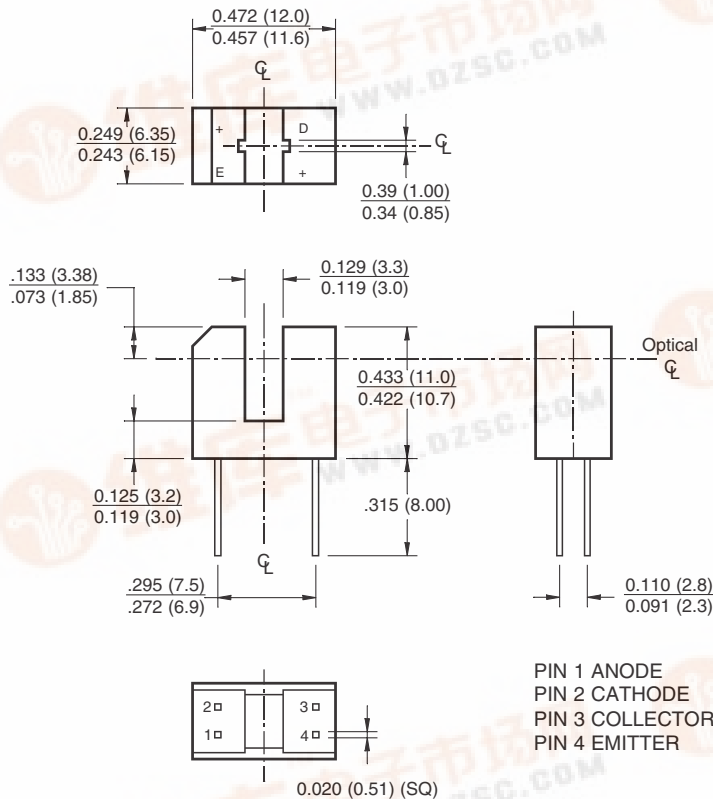

PIN 1 ANODE
PIN 2 CATHODE
PIN 3 COLLECTOR
PIN 4 EMITTER

NOTES:

1. Dimensions for all drawings are in inches (mm).
2. Tolerance of $\pm .010$ (.25) on all non-nominal dimensions unless otherwise specified.

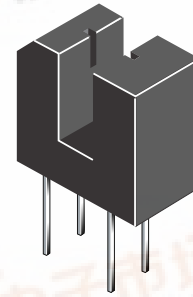

SCHEMATIC

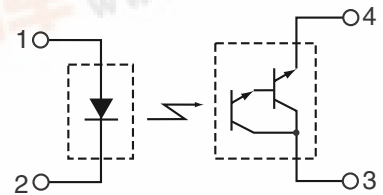

DESCRIPTION

The H22B4, H22B5 and H22B6 consist of a gallium arsenide infrared emitting diode coupled with a silicon photodarlington in a plastic housing. The packaging system is designed to optimize the mechanical resolution, coupling efficiency, ambient light rejection, cost and reliability. The gap in the housing provides a means of interrupting the signal with an opaque material, switching the output from an "ON" to an "OFF" state.

FEATURES

- Opaque housing
- Low cost

035" apertures



H22B4

H22B5

H22B6

ABSOLUTE MAXIMUM RATINGS ($T_A = 25^\circ\text{C}$ unless otherwise specified)			
Parameter	Symbol	Rating	Unit
Operating Temperature	T_{OPR}	-55 to +100	$^\circ\text{C}$
Storage Temperature	T_{STG}	-55 to +100	$^\circ\text{C}$
Soldering Temperature (Iron) ^(2,3 and 4)	$T_{\text{SOL-I}}$	240 for 5 sec	$^\circ\text{C}$
Soldering Temperature (Flow) ^(2 and 3)	$T_{\text{SOL-F}}$	260 for 10 sec	$^\circ\text{C}$
INPUT (EMITTER)			
Continuous Forward Current	I_F	50	mA
Reverse Voltage	V_R	6	V
Power Dissipation ⁽¹⁾	P_D	100	mW
OUTPUT (SENSOR)			
Collector to Emitter Voltage	V_{CEO}	55	V
Emitter to Collector Voltage	V_{ECO}	6	V
Collector Current	I_C	40	mA
Power Dissipation ($T_C = 25^\circ\text{C}$) ⁽¹⁾	P_D	150	mW

NOTES:

1. Derate power dissipation linearly 1.33 mW/ $^\circ\text{C}$ above 25 $^\circ\text{C}$.
2. RMA flux is recommended.
3. Methanol or isopropyl alcohols are recommended as cleaning agents.
4. Soldering iron 1/16" (1.6 mm) minimum from housing.

H22B4

H22B5

H22B6

ELECTRICAL/OPTICAL CHARACTERISTICS (T _A = 25°C)							
PARAMETER	TEST CONDITIONS	SYMBOL	DEVICES	MIN	TYP	MAX	UNITS
INPUT (EMITTER)							
Forward Voltage	I _F = 60 mA	V _F	All	—	—	1.7	V
Reverse Breakdown Voltage	I _R = 10 μA	V _R	All	6.0	—	—	V
Reverse Leakage Current	V _R = 3 V	I _R	All	—	—	1.0	μA
OUTPUT (SENSOR)							
Emitter to Collector Breakdown	I _F = 100 μA, E _e = 0	BV _{ECO}	All	7.0	—	—	V
Collector to Emitter Breakdown	I _C = 1 mA, E _e = 0	BV _{CEO}	All	55	—	—	V
Collector to Emitter Leakage	V _{CE} = 45 V, E _e = 0	I _{CEO}	All	—	—	100	nA
COUPLED							
On-State Collector Current	I _F = 2 mA, V _{CE} = 1.5 V	I _{C(ON)}	H22B4	0.5	—	—	mA
			H22B5	1.0	—	—	
			H22B6	2.0	—	—	
	I _F = 5 mA, V _{CE} = 1.5 V		H22B4	2.5	—	—	
			H22B5	5.0	—	—	
			H22B6	10	—	—	
	I _F = 10 mA, V _{CE} = 1.5 V		H22B4	7.5	—	—	
			H22B5	14	—	—	
			H22B6	25	—	—	
Saturation Voltage	I _F = 10 mA, I _C = 1.8 mA	V _{CE(SAT)}	All	—	—	1.0	V
	I _F = 60 mA, I _C = 50 mA		H22B5/6	—	—	1.5	V
Turn-On Time	I _F = 10 mA, V _{CC} = 5 V, R _L = 750Ω	t _{on}	All	—	45	—	μs
	I _F = 60 mA, V _{CC} = 5 V, R _L = 75Ω		All	—	7	—	
Turn-Off Time	I _F = 10 mA, V _{CC} = 5 V, R _L = 750Ω	t _{off}	All	—	250	—	μs
	I _F = 60 mA, V _{CC} = 5 V, R _L = 75Ω		All	—	45	—	

H22B4

H22B5

H22B6

Figure 1. Output Current vs. Input Current

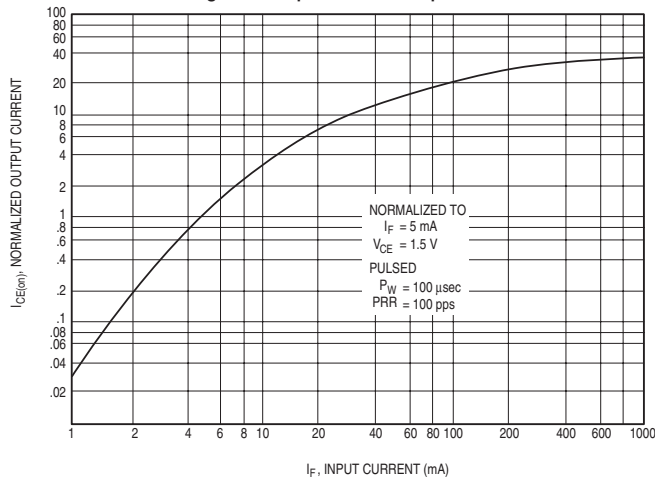

Figure 2. Output Current vs. Temperature

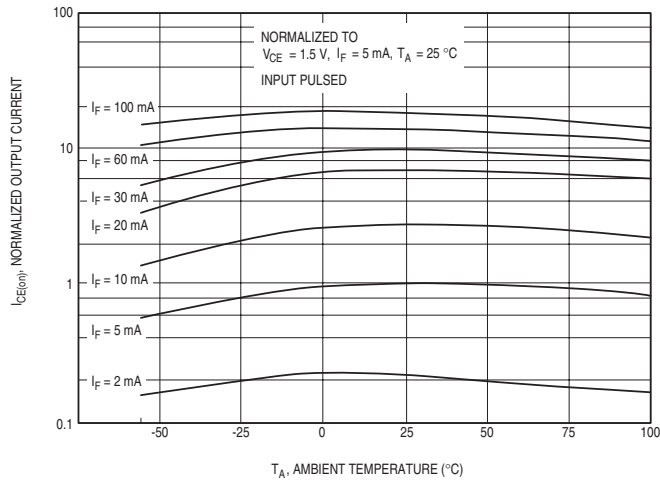
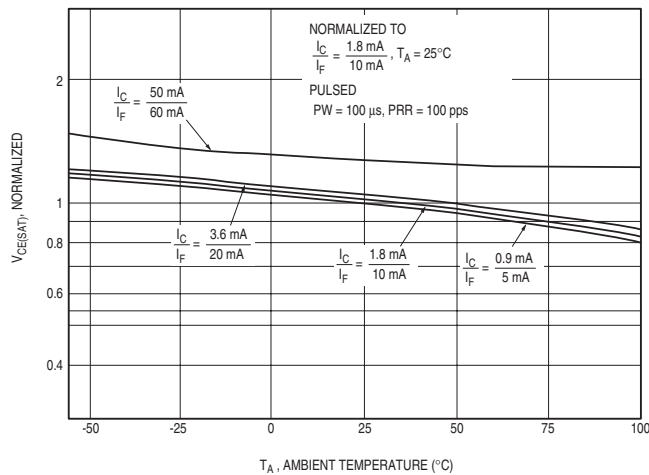

Figure 3. $V_{CE(SAT)}$ vs. Temperature



H22B4

H22B5

H22B6

Figure 4. Leakage Current vs. Temperature

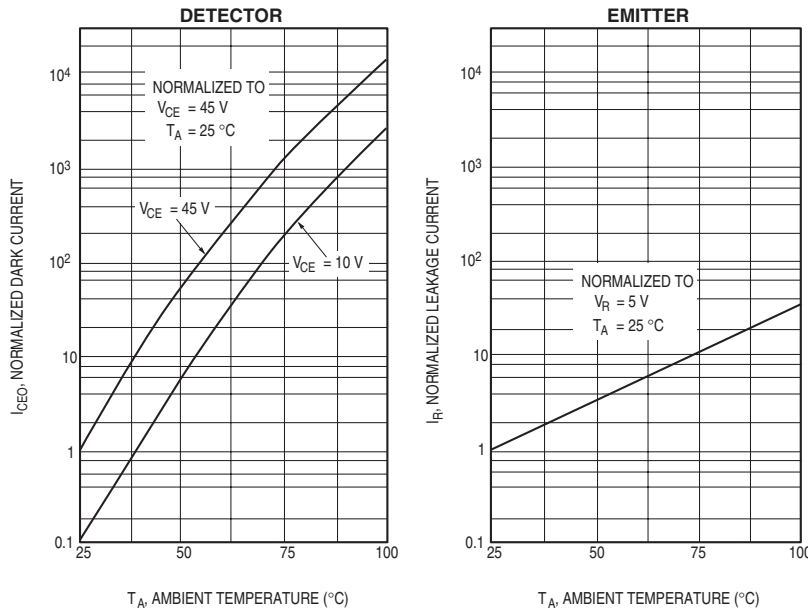

Figure 5. Switching Speed vs. R_L

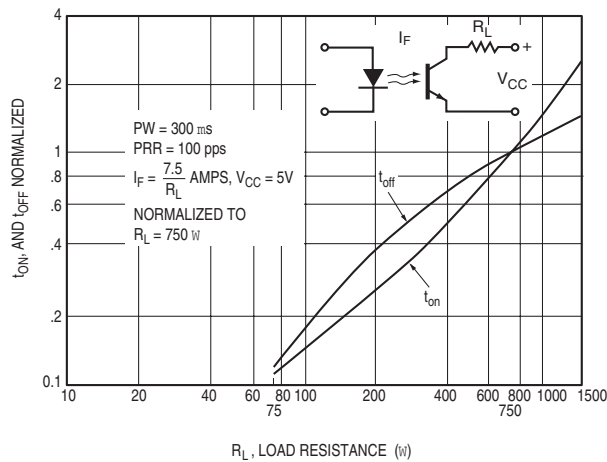
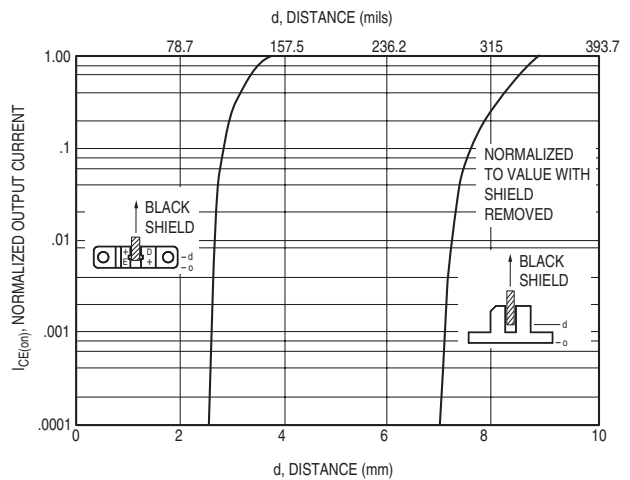

Figure 6. Output Current vs. Distance





PHOTODARLINGTON OPTICAL INTERRUPTER SWITCH

H22B4**H22B5****H22B6**

DISCLAIMER

FAIRCHILD SEMICONDUCTOR RESERVES THE RIGHT TO MAKE CHANGES WITHOUT FURTHER NOTICE TO ANY PRODUCTS HEREIN TO IMPROVE RELIABILITY, FUNCTION OR DESIGN. FAIRCHILD DOES NOT ASSUME ANY LIABILITY ARISING OUT OF THE APPLICATION OR USE OF ANY PRODUCT OR CIRCUIT DESCRIBED HEREIN; NEITHER DOES IT CONVEY ANY LICENSE UNDER ITS PATENT RIGHTS, NOR THE RIGHTS OF OTHERS.

LIFE SUPPORT POLICY

FAIRCHILD'S PRODUCTS ARE NOT AUTHORIZED FOR USE AS CRITICAL COMPONENTS IN LIFE SUPPORT DEVICES OR SYSTEMS WITHOUT THE EXPRESS WRITTEN APPROVAL OF THE PRESIDENT OF FAIRCHILD SEMICONDUCTOR CORPORATION. As used herein:

1. Life support devices or systems are devices or systems which, (a) are intended for surgical implant into the body, or (b) support or sustain life, and (c) whose failure to perform when properly used in accordance with instructions for use provided in the labeling, can be reasonably expected to result in a significant injury of the user.
2. A critical component in any component of a life support device or system whose failure to perform can be reasonably expected to cause the failure of the life support device or system, or to affect its safety or effectiveness.