



# STTH5R06

## TURBO 2 ULTRAFAST HIGH VOLTAGE RECTIFIER

**Table 1: Main Product Characteristics**

$I_{F(AV)}$	5 A
$V_{RRM}$	600 V
$T_j$	175°C
$V_F$ (typ)	1.4 V
$t_{rr}$ (max)	40 ns

**FEATURES AND BENEFITS**

- Ultrafast switching
- Low reverse recovery current
- Low thermal resistance
- Reduces switching losses

**DESCRIPTION**

The STTH5R06, which is using ST Turbo 2 600V technology, is specially suited as boost diode in continuous mode power factor corrections and hard switching conditions. This device is also intended for use as a free wheeling diode in power supplies and other power switching applications.

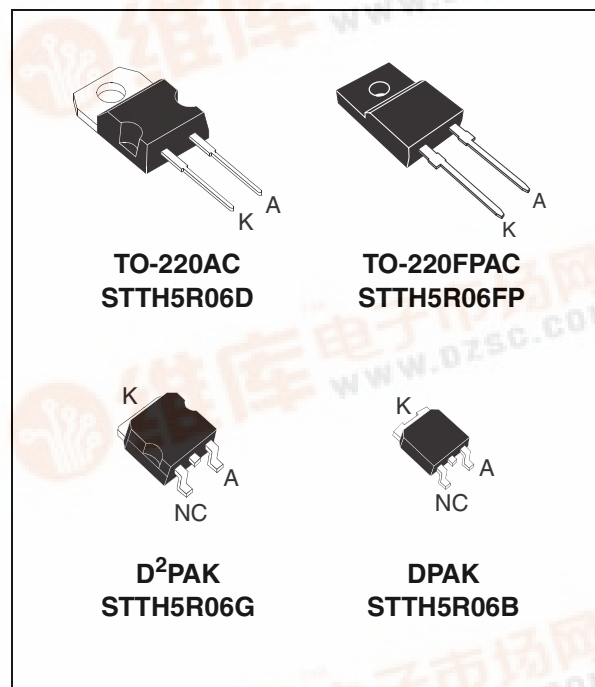

**Table 2: Order Codes**

Part Number	Marking
STTH5R06D	STTH5R06D
STTH5R06FP	STTH5R06FP
STTH5R06B	STTH5R06B

Part Number	Marking
STTH5R06B-TR	STTH5R06B
STTH5R06G	STTH5R06G
STTH5R06G-TR	STTH5R06G

**Table 3: Absolute Ratings** (limiting values)

Symbol	Parameter		Value	Unit	
$V_{RRM}$	Repetitive peak reverse voltage		600	V	
$I_{F(RMS)}$	RMS forward voltage	TO-220AC / TO-220FPAC / D <sup>2</sup> PAK	20	A	
		DPAK	10		
$I_{F(AV)}$	Average forward current	TO-220AC / DPAK / D <sup>2</sup> PAK	$T_c = 135^\circ\text{C} \quad \delta = 0.5$	A	
		TO-220FPAC	$T_c = 105^\circ\text{C} \quad \delta = 0.5$		
$I_{FSM}$	Surge non repetitive forward current		$t_p = 10\text{ms}$ sinusoidal	50	A
$T_{stg}$	Storage temperature range		-65 to + 175	°C	
$T_j$	Maximum operating junction temperature		175	°C	



# STTH5R06

**Table 4: Thermal Resistance**

Symbol	Parameter		Value (max).	Unit
$R_{th(j-c)}$	Junction to case	TO-220AC / DPA / D <sup>2</sup> PAK	3.0	°C/W
		TO-220FPAC	5.5	

**Table 5: Static Electrical Characteristics**

Symbol	Parameter	Test conditions		Min.	Typ	Max.	Unit
$I_R^*$	Reverse leakage current	$T_j = 25^\circ\text{C}$	$V_R = V_{RRM}$			20	$\mu\text{A}$
		$T_j = 125^\circ\text{C}$			25	250	
$V_F^{**}$	Forward voltage drop	$T_j = 25^\circ\text{C}$	$I_F = 5\text{A}$			2.9	V
		$T_j = 125^\circ\text{C}$			1.4	1.8	

Pulse test: \*  $t_p = 5\text{ ms}$ ,  $\delta < 2\%$   
 \*\*  $t_p = 380\ \mu\text{s}$ ,  $\delta < 2\%$

To evaluate the conduction losses use the following equation:  $P = 1.164 \times I_F(\text{AV}) + 0.128 I_F^2(\text{RMS})$

**Table 6: Dynamic Characteristics**

Symbol	Parameter	Test conditions		Min.	Typ	Max.	Unit
$t_{rr}$	Reverse recovery time	$T_j = 25^\circ\text{C}$	$I_F = 0.5\text{A}$ $I_{rr} = 0.25\text{A}$ $I_R = 1\text{A}$			25	ns
			$I_F = 1\text{A}$ $di_F/dt = -50\text{ A}/\mu\text{s}$ $V_R = 30\text{V}$			40	
$I_{RM}$	Reverse recovery current	$T_j = 125^\circ\text{C}$	$I_F = 5\text{A}$ $V_R = 400\text{V}$ $di_F/dt = -200\text{ A}/\mu\text{s}$		5.0	6.0	A
S factor	Softness factor				0.35		
Qrr	Reverse recovery charges				110		nC
$t_{fr}$	Forward recovery time	$T_j = 25^\circ\text{C}$	$I_F = 5\text{A}$ $di_F/dt = 40\text{ A}/\mu\text{s}$ $V_{FR} = 1.1 \times V_{Fmax}$			150	ns
$V_{FP}$	Forward recovery voltage	$T_j = 25^\circ\text{C}$	$I_F = 5\text{A}$ $di_F/dt = 40\text{ A}/\mu\text{s}$ $V_{FR} = 1.1 \times V_{Fmax}$			4.5	V

**Figure 1: Conduction losses versus average current**

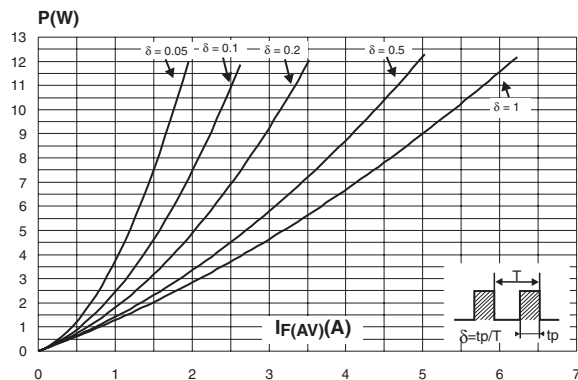

**Figure 2: Forward voltage drop versus forward current**

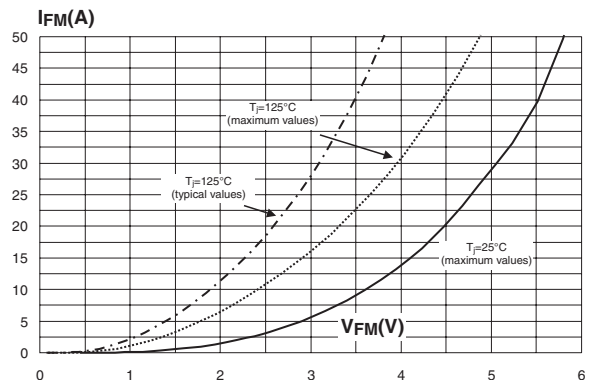

**Figure 3: Relative variation of thermal impedance junction to case versus pulse duration (TO-220AC, DPAK, D<sup>2</sup>PAK)**

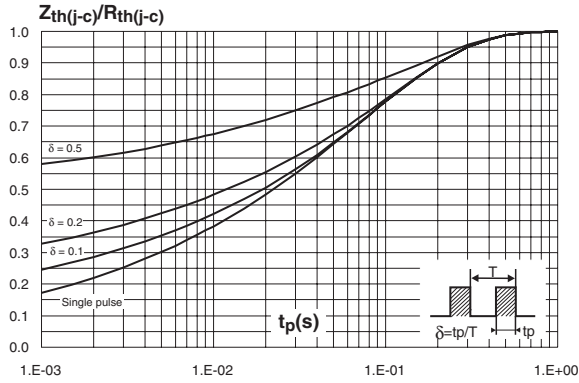

**Figure 4: Relative variation of thermal impedance junction to case versus pulse duration (TO-220FPAC)**

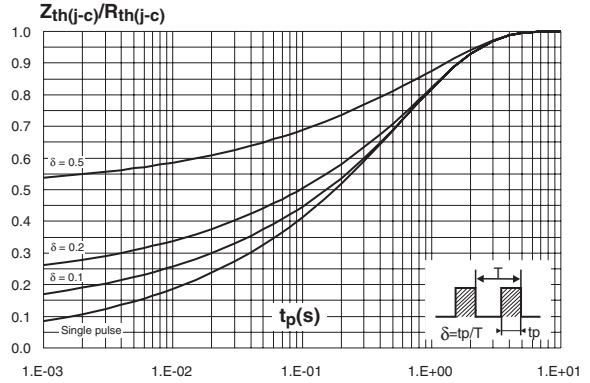

**Figure 5: Peak reverse recovery current versus  $di_F/dt$  (90% confidence)**

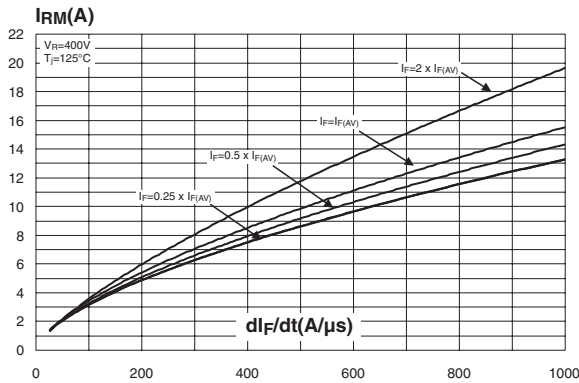

**Figure 6: Reverse recovery time versus  $di_F/dt$  (90% confidence)**

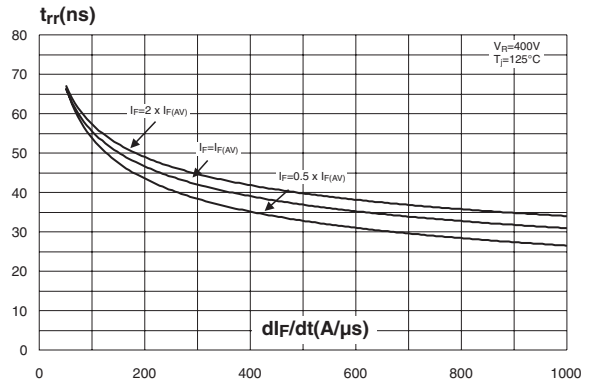

**Figure 7: Reverse recovery charges versus  $di_F/dt$  (90% confidence)**

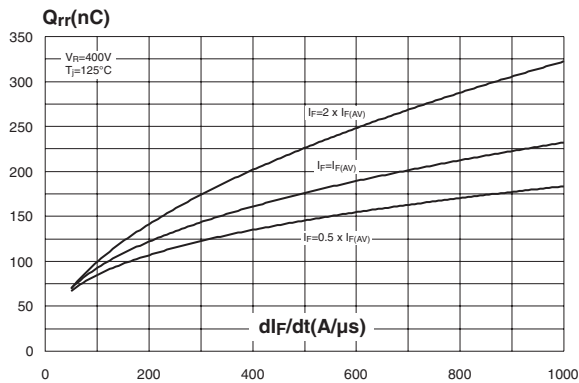

**Figure 8: Softness factor versus  $di_F/dt$  (typical values)**

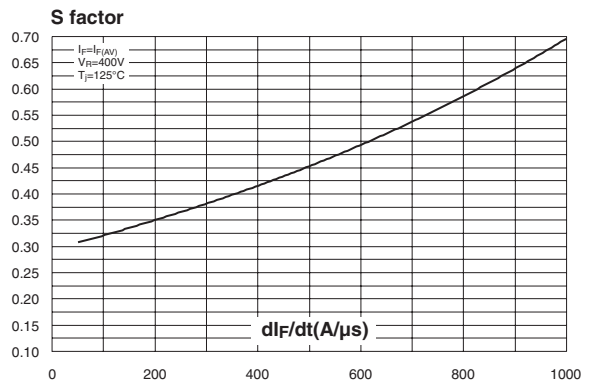

Figure 9: Relative variations of dynamic parameters versus junction temperature

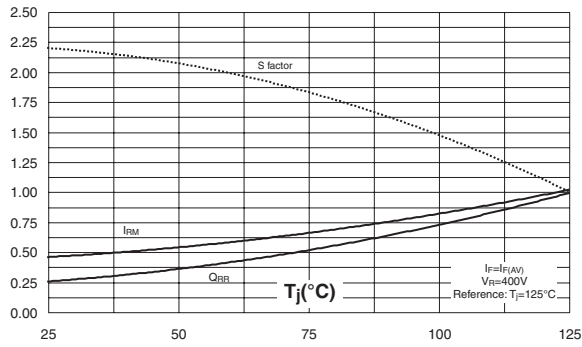

Figure 10: Transient peak forward voltage versus  $di_F/dt$  (90% confidence)

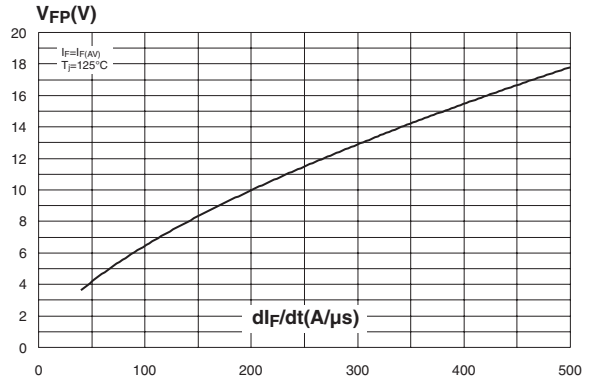

Figure 11: Forward recovery time versus  $di_F/dt$  (90% confidence)

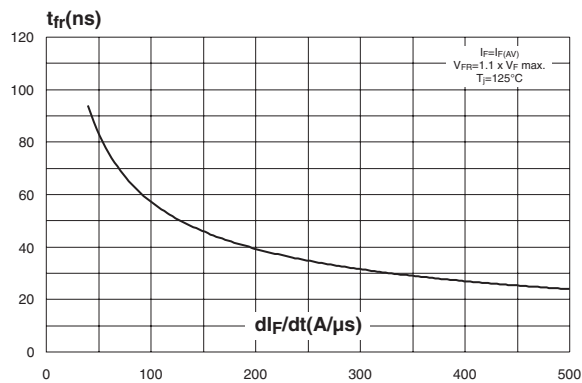

Figure 12: Junction capacitance versus reverse voltage applied (typical values)

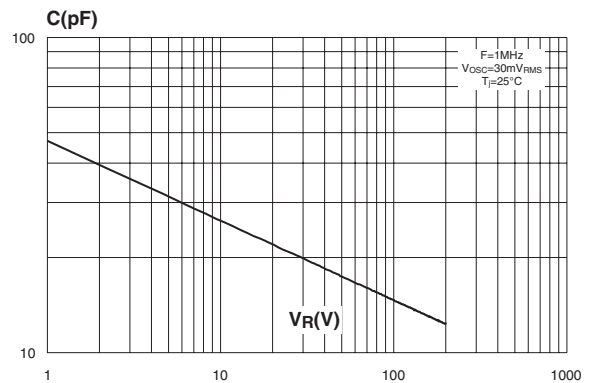

Figure 13: Thermal resistance junction to ambient versus copper surface under tab (epoxy FR4,  $e_{Cu} = 35\mu m$ ) (DPAK and D<sup>2</sup>PAK)

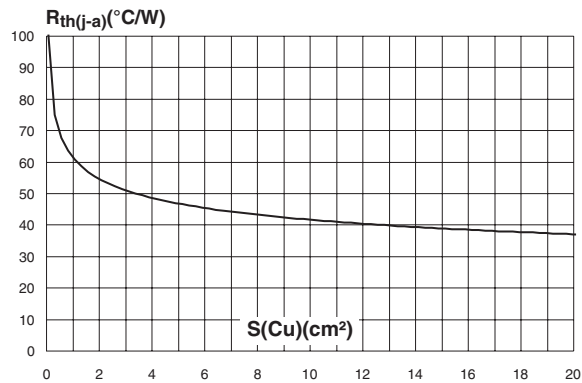

Figure 14: DPAK Package Mechanical Data

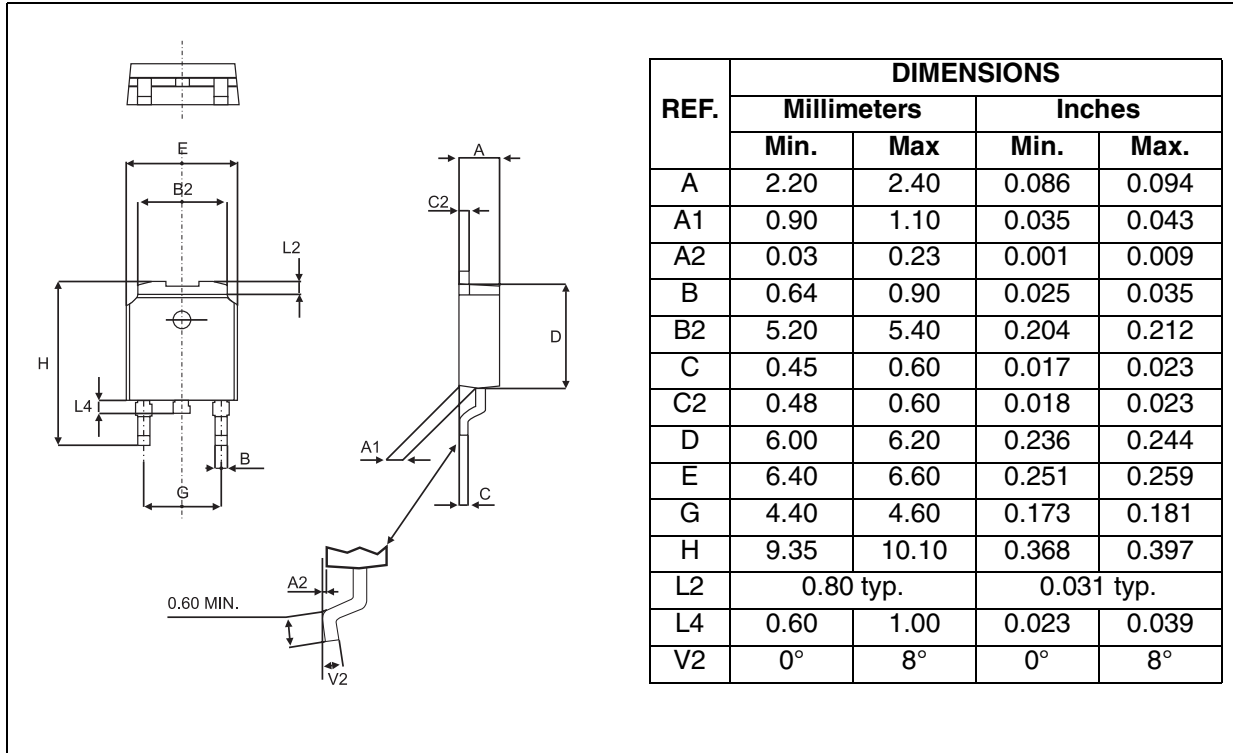

Figure 15: DPAK Foot Print Dimensions (in millimeters)

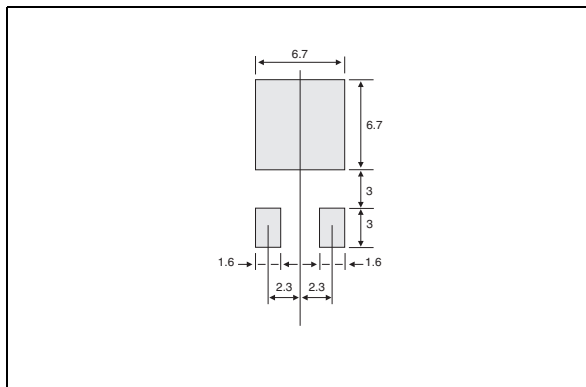

Figure 16: D<sup>2</sup>PAK Package Mechanical Data

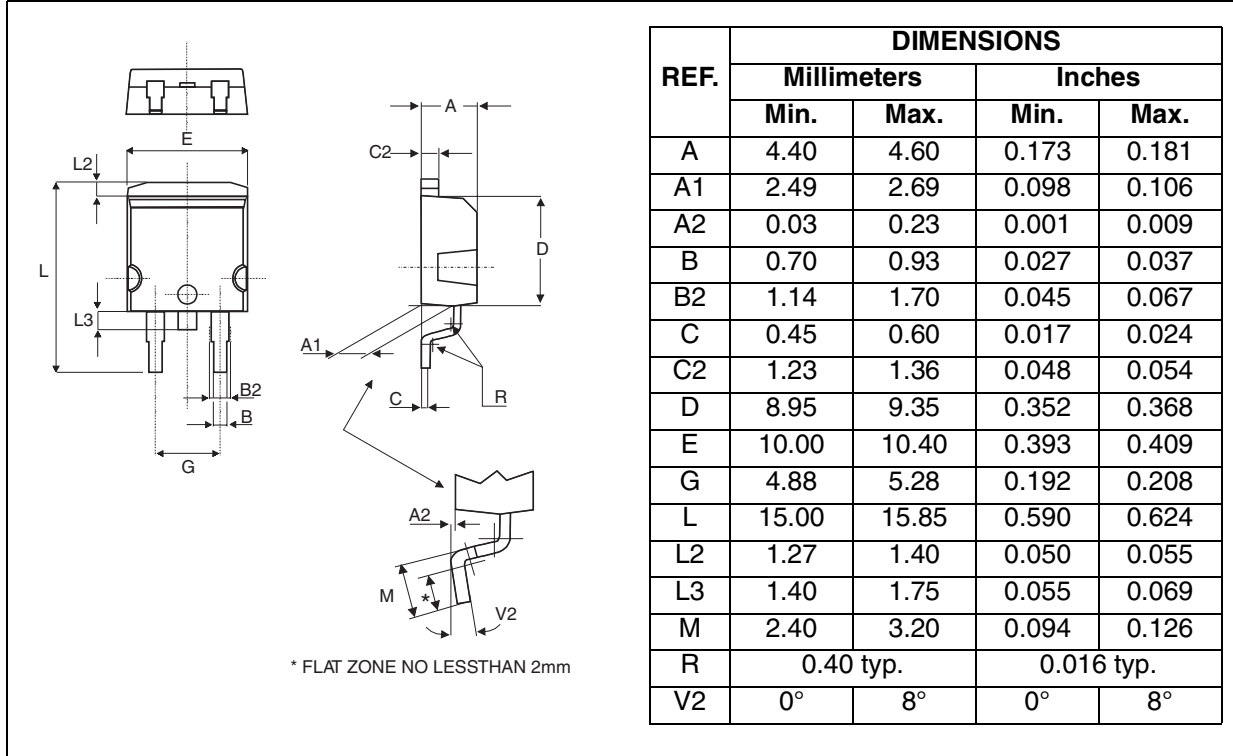

Figure 17: D<sup>2</sup>PAK Foot Print Dimensions (in millimeters)

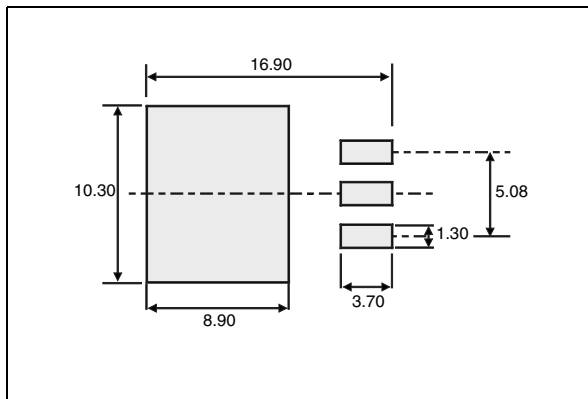

Figure 18: TO-220FPAC Package Mechanical Data

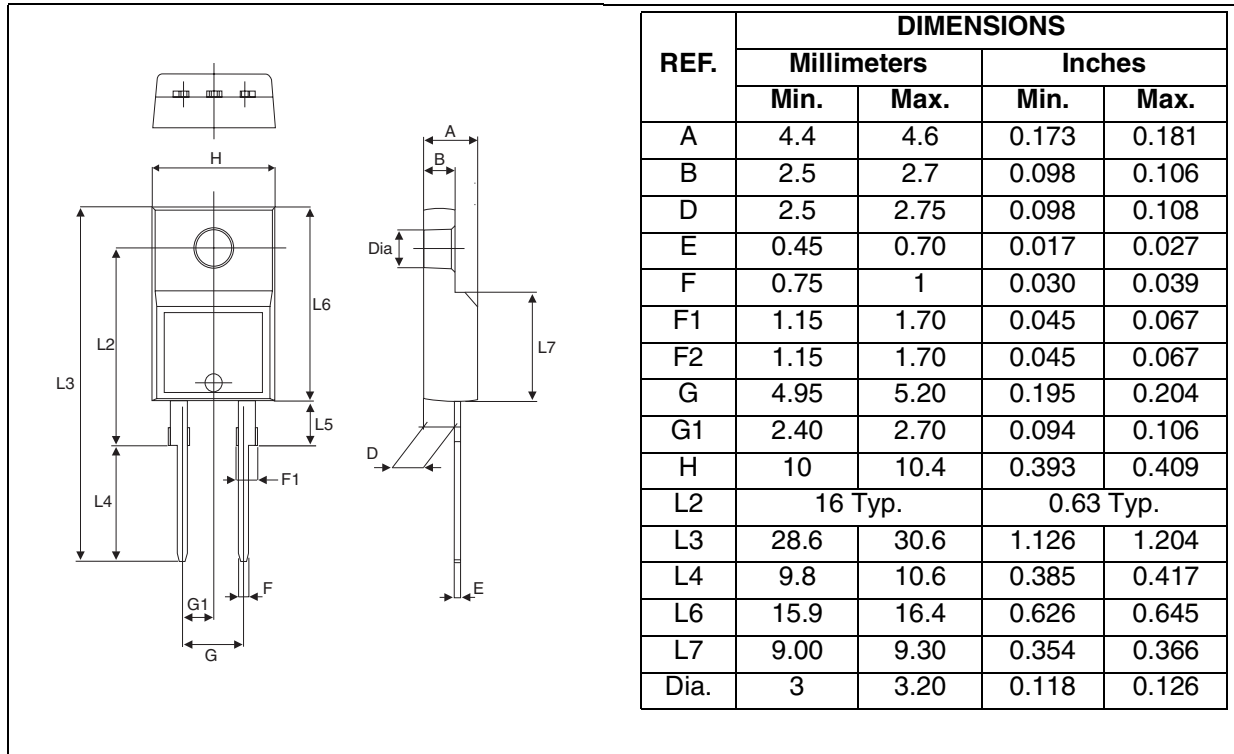
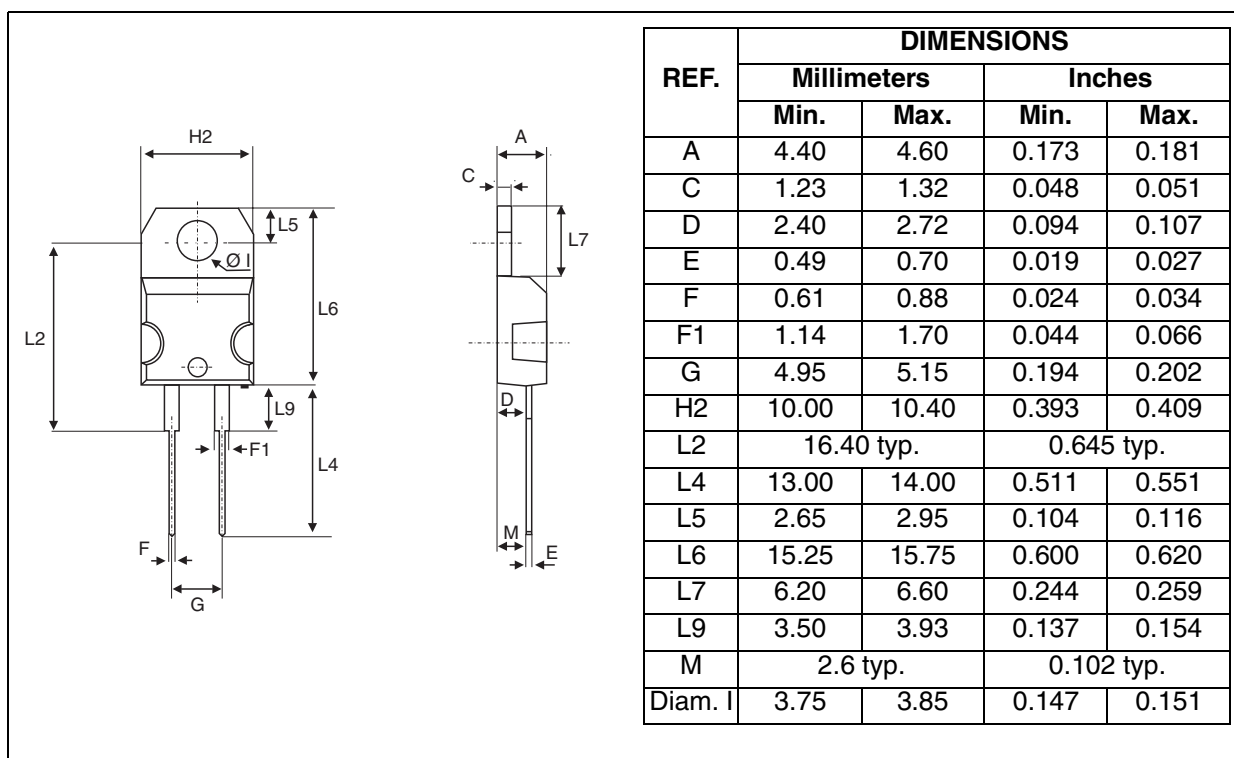

Figure 19: TO-220AC Package Mechanical Data



## STTH5R06

---

**Table 7: Ordering Information**

Ordering type	Marking	Package	Weight	Base qty	Delivery mode
STTH5R06D	STTH5R06D	TO-220AC	1.90 g	50	Tube
STTHR5R06G	STTH5R06G	D <sup>2</sup> PAK	1.48 g	50	Tube
STTHR5R06G-TR	STTHR5R06G	D <sup>2</sup> PAK	1.48 g	1000	Tape & reel
STTHR5R06FP	STTHR5R06FP	TO-220FPAC	1.70 g	50	Tube
STTHR5R06B	STTHR5R06B	DPAK	0.3 g	75	Tube
STTHR5R06B-TR	STTHR5R06B-TR	DPAK	0.3 g	2500	Tape & reel

- Epoxy meets UL94, V0
- Cooling method: by conduction (C)
- Recommended torque value: 0.8 m.N. (TO-220FPAC) / 0.55 m.N. (TO-220AC)
- Maximum torque value: 1.0 m.N. (TO-220FPAC) / 0.70 m.N. (TO-220AC)

**Table 8: Revision History**

Date	Revision	Description of Changes
Oct-2002	3	Last update
07-Sep-2004	4	Tcases values splitted for TO-220FPAC package



Information furnished is believed to be accurate and reliable. However, STMicroelectronics assumes no responsibility for the consequences of use of such information nor for any infringement of patents or other rights of third parties which may result from its use. No license is granted by implication or otherwise under any patent or patent rights of STMicroelectronics. Specifications mentioned in this publication are subject to change without notice. This publication supersedes and replaces all information previously supplied. STMicroelectronics products are not authorized for use as critical components in life support devices or systems without express written approval of STMicroelectronics.

The ST logo is a registered trademark of STMicroelectronics.  
All other names are the property of their respective owners

© 2004 STMicroelectronics - All rights reserved

**STMicroelectronics group of companies**

Australia - Belgium - Brazil - Canada - China - Czech Republic - Finland - France - Germany - Hong Kong - India - Israel - Italy - Japan -  
Malaysia - Malta - Morocco - Singapore - Spain - Sweden - Switzerland - United Kingdom - United States of America

[www.st.com](http://www.st.com)