

## Selectable, Four Channel Video Operational Amplifier

August 1998

### Features

- This Circuit is Processed in Accordance to MIL-STD-883 and is Fully Conformant Under the Provisions of Paragraph 1.2.1.
- Digital Selection of Input Channel
- Unity Gain Stable
- Gain Flatness (to 10MHz) ..... 0.12dB (Typ)
- Differential Gain ..... 0.03% (Typ)
- Differential Phase ..... 0.03 Degrees (Typ)
- Fast Channel Selection ..... 100ns (Max)
- Crosstalk Rejection ..... 60dB (Typ)

### Applications

- Programmable Gain Amplifier
- Special Effects Processors
- Video Distribution Systems/Multiplexers
- Heads-up/Night Vision Displays
- Radar Video
- Flight Simulators
- IR Imaging

### Ordering Information

PART NUMBER	TEMPERATURE RANGE	PACKAGE
HA1-2444/883	-55°C to +125°C	16 Lead CerDIP

### Pinout

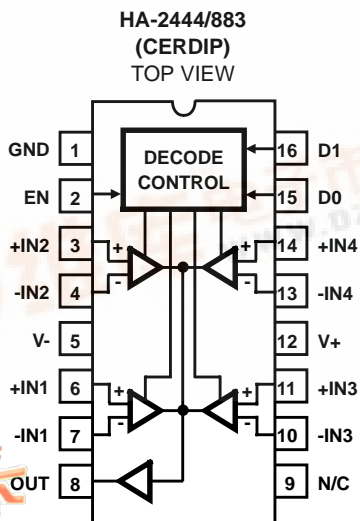

### Description

The HA-2444/883 is a channel-selectable video op amp consisting of four differential inputs, a single-ended output, and digital control circuitry allowing two digital inputs to activate one of the four differential inputs. The HA-2444/883 also includes a high impedance output state allowing the outputs of multiple HA-2444/883s to be wire-OR'd. Functionally, the HA-2444/883 is equivalent to four wideband video op amps and a wideband multiplexer.

Unlike similar competitor devices, the HA-2444/883 is not restricted to multiplexing. Any op amp configuration can be used with any of the inputs. Signal amplification, addition, integration, and more can be put under digital control with broadcast quality performance.

The key video parameters of the HA-2444/883 have been optimized without compromising DC performance. Gain Flatness, to 10MHz, is only 0.12dB. Differential gain and phase are typically 0.03% and 0.03 degrees, respectively.

Laser trimming allows offset voltages in the 4.0mV range and a unique common current source design assures minimal channel-to-channel mismatch, while maintaining 60dB of crosstalk rejection at 5MHz. Open loop gain of 76dB and low input offset and bias currents enhance the performance of this versatile device.

Uses for the HA-2444/883 include video test equipment, guidance systems, radar displays, and other precise imaging systems where stringent gain and phase requirements have previously required costly hybrids and discrete circuitry. It will also be used for systems requiring high speed signal conditioning, such as data acquisition systems, specialized instrumentation, and communications systems.

### Logic Operation

TRUTH TABLE

EN	D1	D0	SELECTED CHANNEL
H	L	L	1
H	L	H	2
H	H	L	3
H	H	H	4
L	X	X	NONE-OUT is set to a high impedance state.

L = Low State (0.8V Max.)  
 H = High State (2.4V Min.)  
 X = Don't Care



## Specifications HA-2444/883

### Absolute Maximum Ratings

Voltage between V+ and V- Terminals	35V
Differential Input Voltage	6V
Voltage at Either Input Terminal	V+ to V-
Voltage on Digital Inputs	GND +7.5V to GND -0.5V
Peak Output Current ( $\leq 10\%$ Duty Cycle)	40mA
Junction Temperature ( $T_J$ )	+175°C
Storage Temperature Range	-65°C to +150°C
ESD Rating	<2000V
Lead Temperature (Soldering 10s)	+300°C

### Thermal Information

Thermal Resistance	$\theta_{JA}$	$\theta_{JC}$
CerDIP Package	82°C/W	27°C/W
Package Power Dissipation Limit at +75°C for $T_J \leq +175^\circ\text{C}$		
CerDIP Package	1.22W	
Package Power Dissipation Derating Factor Above +75°C		
CerDIP Package	12.2mW/°C	

CAUTION: Stresses above those listed in "Absolute Maximum Ratings" may cause permanent damage to the device. This is a stress only rating and operation of the device at these or any other conditions above those indicated in the operational sections of this specification is not implied.

### Operating Conditions

Operating Temperature Range	-55°C to +125°C	$V_{INCM} \leq 1/2(V+ - V-)$
Operating Supply Voltage	$\pm 12\text{V}$ to $\pm 15\text{V}$	$R_L \geq 1\text{k}\Omega$

**TABLE 1. DC ELECTRICAL PERFORMANCE CHARACTERISTICS**

Device Tested at:  $V_{SUPPLY} = \pm 15\text{V}$ ,  $R_{SOURCE} = 50\Omega$ ,  $R_{LOAD} = 1\text{k}\Omega$ ,  $C_{LOAD} \leq 10\text{pF}$ ,  $V_{OUT} = 0\text{V}$ ,  $V_{IL} = 0.8\text{V}$ ,  $V_{IH} = 2.4\text{V}$ , Unless Otherwise Specified.

PARAMETERS	SYMBOL	CONDITIONS	GROUP A SUBGROUP	TEMPERATURE	LIMITS		UNITS
					MIN	MAX	
Input Offset Voltage	$V_{IO}$	$V_{CM} = 0\text{V}$	1	+25°C	-7	7	mV
			2, 3	+125°C, -55°C	-20	20	mV
Channel to Channel Offset Voltage Mismatch	$V_{IODEV}$	$V_{CM} = 0\text{V}$	1	+25°C	-	5	mV
			2, 3	+125°C, -55°C	-	12	mV
Input Bias Current	+ $I_B$	$V_{CM} = 0\text{V}$ , $+R_S = 250\Omega$ $-R_S = 50\Omega$	1	+25°C	-15	15	$\mu\text{A}$
			2, 3	+125°C, -55°C	-25	25	$\mu\text{A}$
	- $I_B$	$V_{CM} = 0\text{V}$ , $+R_S = 50\Omega$ $-R_S = 250\Omega$	1	+25°C	-15	15	$\mu\text{A}$
			2, 3	+125°C, -55°C	-25	25	$\mu\text{A}$
Input Offset Current	$I_{IO}$	$V_{CM} = 0\text{V}$ , $+R_S = 250\Omega$ $-R_S = 250\Omega$	1	+25°C	-4	4	$\mu\text{A}$
			2, 3	+125°C, -55°C	-8	8	$\mu\text{A}$
Large Signal Voltage Gain	+ $A_{VOL}$	$V_{OUT} = 0\text{V}$ and +5V	4	+25°C	71	-	dB
			5, 6	+125°C, -55°C	65	-	dB
	- $A_{VOL}$	$V_{OUT} = 0\text{V}$ and -5V	4	+25°C	71	-	dB
			5, 6	+125°C, -55°C	65	-	dB
Common Mode Rejection Ratio	+CMRR	$\Delta V_{CM} = +5\text{V}$ , $V_{OUT} = -5\text{V}$ , $V+ = 10\text{V}$ , $V- = -20\text{V}$	1	+25°C	68	-	dB
			2, 3	+125°C, -55°C	68	-	dB
	-CMRR	$\Delta V_{CM} = -5\text{V}$ , $V_{OUT} = +5\text{V}$ , $V+ = 20\text{V}$ , $V- = -10\text{V}$	1	+25°C	68	-	dB
			2, 3	+125°C, -55°C	68	-	dB
Output Voltage Swing	+ $V_{OUT}$		1	+25°C	10	-	V
			2, 3	+125°C, -55°C	10	-	V
	- $V_{OUT}$		1	+25°C	-	-10	V
			2, 3	+125°C, -55°C	-	-10	V
Output Current	+ $I_{OUT}$	$V_{OUT} = -10\text{V}$ $R_{LOAD} = \text{OPEN}$	1	+25°C	25	-	mA
			2, 3	+125°C, -55°C	25	-	mA
	- $I_{OUT}$	$V_{OUT} = 10\text{V}$ $R_{LOAD} = \text{OPEN}$	1	+25°C	-	-25	mA
			2, 3	+125°C, -55°C	-	-25	mA
Output Current (Device Disabled)	+DISAB	$V_{OUT} = 5\text{V}$ , $V_{EN} = 0.8\text{V}$ $R_{LOAD} = \text{OPEN}$	1	+25°C	-	860	$\mu\text{A}$
			2, 3	+125°C, -55°C	-	860	$\mu\text{A}$
	-DISAB	$V_{OUT} = -5\text{V}$ , $V_{EN} = 0.8\text{V}$ $R_{LOAD} = \text{OPEN}$	1	+25°C	-	860	$\mu\text{A}$
			2, 3	+125°C, -55°C	-	860	$\mu\text{A}$

## Specifications HA-2444/883

**TABLE 1. DC ELECTRICAL PERFORMANCE CHARACTERISTICS**

Device Tested at:  $V_{SUPPLY} = \pm 15V$ ,  $R_{SOURCE} = 50\Omega$ ,  $R_{LOAD} = 1k\Omega$ ,  $C_{LOAD} \leq 10pF$ ,  $V_{OUT} = 0V$ ,  $V_{IL} = 0.8V$ ,  $V_{IH} = 2.4V$ ,  
Unless Otherwise Specified. **(Continued)**

PARAMETERS	SYMBOL	CONDITIONS	GROUP A SUBGROUP	TEMPERATURE	LIMITS		UNITS
					MIN	MAX	
Quiescent Power Supply Current	+I <sub>CC</sub>	V <sub>OUT</sub> = 0V I <sub>OUT</sub> = 0mA	1	+25°C	-	25	mA
			2, 3	+125°C, -55°C	-	25	mA
	-I <sub>CC</sub>	V <sub>OUT</sub> = 0V I <sub>OUT</sub> = 0mA	1	+25°C	-25	-	mA
			2, 3	+125°C, -55°C	-25	-	mA
Supply Current (Device Disabled)	+I <sub>CCDIS</sub>	V <sub>OUT</sub> = 0V V <sub>EN</sub> = 0.8V	1	+25°C	-	10	mA
			2, 3	+125°C, -55°C	-	10	mA
	-I <sub>CCDIS</sub>	V <sub>OUT</sub> = 0V V <sub>EN</sub> = 0.8V	1	+25°C	-10	-	mA
			2, 3	+125°C, -55°C	-10	-	mA
Power Supply Rejection Ratio	+PSRR	$\Delta V_{SUPPLY} = 5V$ , V <sub>+</sub> = 15V, V <sub>-</sub> = -15V V <sub>+</sub> = 20V, V <sub>-</sub> = -15V	1	+25°C	65	-	dB
			2, 3	+125°C, -55°C	65	-	dB
	-PSRR	$\Delta V_{SUPPLY} = 5V$ , V <sub>+</sub> = 15V, V <sub>-</sub> = -15V V <sub>+</sub> = 15V, V <sub>-</sub> = -20V	1	+25°C	65	-	dB
			2, 3	+125°C, -55°C	65	-	dB
Digital Input Voltages (D0, D1, EN)	V <sub>IL</sub>		1	+25°C	-	0.8	V
			2, 3	+125°C, -55°C	-	0.8	V
	V <sub>IH</sub>		1	+25°C	2.4	-	V
			2, 3	+125°C, -55°C	2.4	-	V
Input Current (D0, D1)	DX <sub>IIL</sub>	V <sub>IL</sub> = 0V	1	+25°C	-	1	mA
			2, 3	+125°C, -55°C	-	1	mA
	DX <sub>IHH</sub>	V <sub>IH</sub> = 5V	1	+25°C	-	1.2	μA
			2, 3	+125°C, -55°C	-	1.2	μA
Input Current (EN)	EN <sub>IIL</sub>	V <sub>IL</sub> = 0V	1	+25°C	-	50	μA
			2, 3	+125°C, -55°C	-	50	μA
	EN <sub>IHH</sub>	V <sub>IH</sub> = 5V	1	+25°C	-	1.2	μA
			2, 3	+125°C, -55°C	-	1.2	μA

**TABLE 2. AC ELECTRICAL PERFORMANCE CHARACTERISTICS**

Device Tested at:  $V_{SUPPLY} = \pm 15V$ ,  $R_{SOURCE} = 50\Omega$ ,  $R_{LOAD} = 1k\Omega$ ,  $C_{LOAD} \leq 10pF$ ,  $A_{VCL} = +1V/V$ ,  $V_{IL} = 0.8V$ ,  $V_{IH} = 2.4V$ ,  
Unless Otherwise Specified.

PARAMETERS	SYMBOL	CONDITIONS	GROUP A SUBGROUP	TEMPERATURE	LIMITS		UNITS
					MIN	MAX	
Slew Rate	+SR	V <sub>OUT</sub> = -5V to +5V	7	+25°C	120	-	V/μs
			8	+125°C, -55°C	120	-	V/μs
	-SR	V <sub>OUT</sub> = +5V to -5V	7	+25°C	120	-	V/μs
			8	+125°C, -55°C	120	-	V/μs
Channel Select Time	CHSE	Note 1 V <sub>EN</sub> = 2.4V	9, 10	+25°C, +125°C	-	100	ns
			11	-55°C	-	125	ns
Output Enable Time	CHEN	Note 2	9	+25°C	-	100	ns
			10, 11	+125°C, -55°C	-	100	ns

**NOTES:**

1. Measured for all channel combinations. Channel Select time is the delay in switching from channel X to channel Y. Channel Y input set to +5V, all other channels set to 0V. Select time is measured from the 50% point of the critical digital select input to the 50% point on the output.
2. Channel 1 selected with the input at 5V. All other channels set to 0V. Enable input switched from 0.8V to 2.4V. Enable time is measured from the 50% point of the EN input to the 50% point on the output.

## Specifications HA-2444/883

**TABLE 3. ELECTRICAL PERFORMANCE CHARACTERISTICS**

Device Characterized at:  $V_{SUPPLY} = \pm 15V$ ,  $R_{SOURCE} = 50\Omega$ ,  $R_{LOAD} = 1k\Omega$ ,  $C_L \leq 10pF$ ,  $A_{VCL} = 1V/V$ ,  $V_{IL} = 0.8V$ ,  $V_{IH} = 2.4V$ , Unless Otherwise Specified.

PARAMETERS	SYMBOL	CONDITIONS	NOTES	TEMPERATURE	LIMITS		UNITS
					MIN	MAX	
Rise Time	$T_R$	$V_{OUT} = 0V$ to $+200mV$	1, 4	$+25^\circ C$	-	11	ns
			1, 4	$-55^\circ C, +125^\circ C$	-	12	ns
Fall Time	$T_F$	$V_{OUT} = 0V$ to $-200mV$	1, 4	$+25^\circ C$	-	11	ns
			1, 4	$-55^\circ C, +125^\circ C$	-	12	ns
Overshoot	+OS	$V_{OUT} = 0V$ to $+200mV$	1	$+25^\circ C$	-	15	%
			1	$-55^\circ C, +125^\circ C$	-	30	%
	-OS	$V_{OUT} = 0V$ to $-200mV$	1	$+25^\circ C$	-	15	%
			1	$-55^\circ C, +125^\circ C$	-	30	%
Full Power Bandwidth	FPBW	$V_{PEAK} = 5V$	1, 2	$+25^\circ C$	3.8	-	MHz
			1, 2	$-55^\circ C, +125^\circ C$	3.8	-	MHz
Minimum Closed Loop Stable Gain	CLSG		1	$+25^\circ C$	1	-	V/V
			1	$-55^\circ C, +125^\circ C$	1	-	V/V
Quiescent Power Consumption	PC	$V_{OUT} = 0V, I_{OUT} = 0mA$	1, 3	$+25^\circ C$	-	750	mW
			1, 3	$-55^\circ C, +125^\circ C$	-	750	mW

**NOTES:**

1. Parameters listed in Table 3 are controlled via design or process parameters and are not directly tested at final production. These parameters are lab characterized upon initial design release, or upon design changes. These parameters are guaranteed by characterization based upon data from multiple production runs which reflect lot to lot and within lot variation.
2. Full Power Bandwidth guarantee based on Slew Rate measurement using  $FPBW = \text{Slew Rate} / (2\pi V_{PEAK})$ .
3. Power Consumption based upon Quiescent Supply Current test maximum. (No load on outputs.)
4. Measured between 10% and 90% points.

**TABLE 4. ELECTRICAL TEST REQUIREMENTS**

MIL-STD-883 TEST REQUIREMENTS	SUBGROUPS (SEE TABLES 1 AND 2)
Interim Electrical Parameters (Pre Burn-In)	1
Final Electrical Test Parameters	1 (Note 1), 2, 3, 4, 5, 6, 7, 8, 9, 10, 11
Group A Test Requirements	1, 2, 3, 4, 5, 6, 7, 8, 9, 10, 11
Groups C and D Endpoints	1

**NOTE:**

1. PDA applies to Subgroup 1 only.

## HA-2444/883

### Die Characteristics

#### DIE DIMENSIONS:

74mils x 103mils x 19mils  $\pm$  1mil  
1880 $\mu$ m x 2620 $\mu$ m x 483 $\mu$ m  $\pm$  25.4 $\mu$ m

#### METALLIZATION:

Type: Al, 1% Cu  
Thickness: 16k $\text{\AA}$   $\pm$  2k $\text{\AA}$

#### SUBSTRATE POTENTIAL (Powered Up): V-

#### GLASSIVATION:

Type: Nitride over Silox  
Silox Thickness: 12k $\text{\AA}$   $\pm$  2k $\text{\AA}$   
Nitride Thickness: 3.5k $\text{\AA}$   $\pm$  1.5k $\text{\AA}$

#### TRANSISTOR COUNT: 129

#### PROCESS: Bipolar Dielectric Isolation

### Metallization Mask Layout

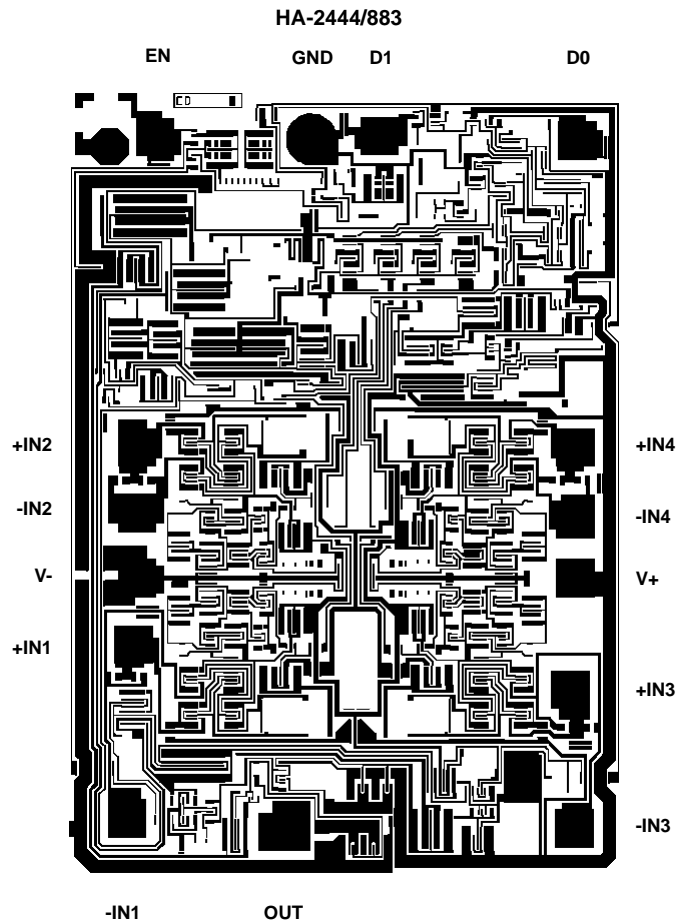

**Test Waveforms**

**SIMPLIFIED TEST CIRCUIT FOR LARGE AND SMALL SIGNAL PULSE RESPONSE** (Applies to Tables 2 and 3)

**$A_V = +1$  TEST CIRCUIT**

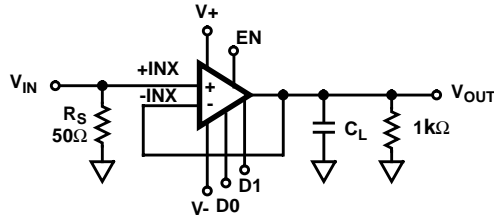

NOTE:

1.  $V_S = \pm 15V$ ,  $A_V = +1$ ,  $C_L \leq 10pF$
2. All 4 Channels Tested
3. D0 and D1 = 2.4V or 0.8V to Select Proper Channel
4. EN = 2.4V

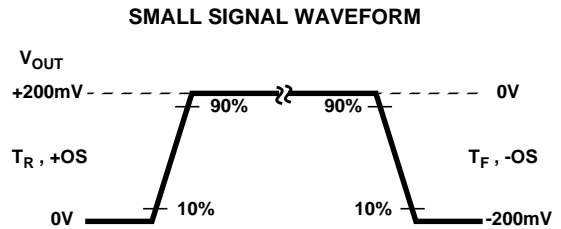
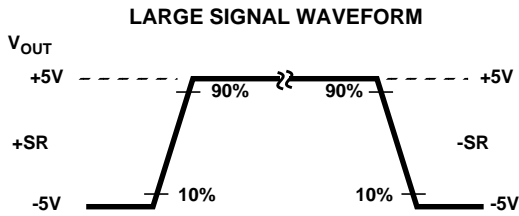

**SIMPLIFIED TEST CIRCUIT FOR CHANNEL SELECT TIMES**

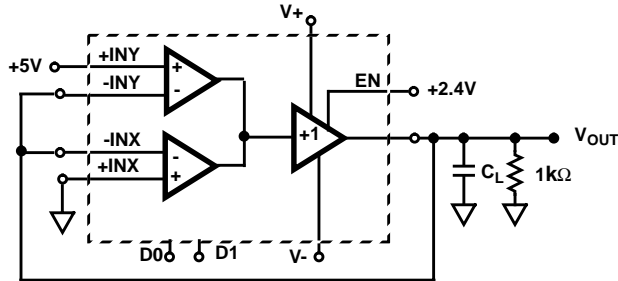

NOTE:

1.  $V_S = \pm 15V$ ,  $A_V = +1$  (all channels),  $C_L \leq 10pF$
2. All Channel Combinations Tested

**SIMPLIFIED TEST CIRCUIT FOR OUTPUT ENABLE TIMES**

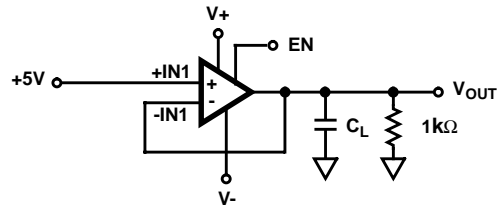

NOTE:

1.  $V_S = \pm 15V$ ,  $A_V = +1$ ,  $C_L \leq 10pF$
2. D0 = D1 = 0.8V, +IN2 = +IN3 = +IN4 = 0V

**CHANNEL SELECT TIME SWITCHING WAVEFORMS**

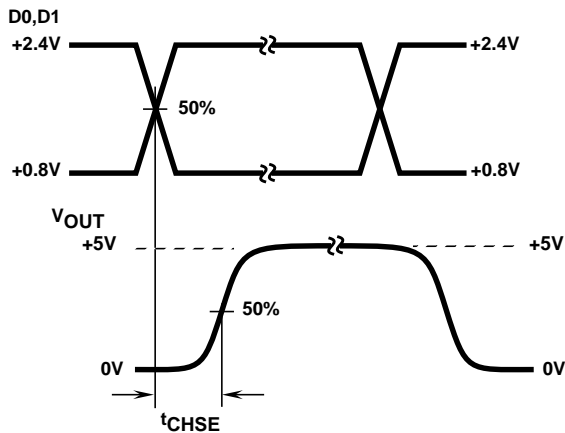

**OUTPUT ENABLE TIME SWITCHING WAVEFORMS**

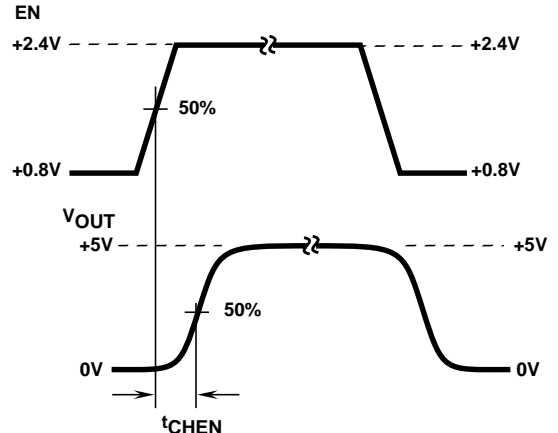

## HA-2444/883

All Intersil semiconductor products are manufactured, assembled and tested under **ISO9000** quality systems certification.

*Intersil products are sold by description only. Intersil Corporation reserves the right to make changes in circuit design and/or specifications at any time without notice. Accordingly, the reader is cautioned to verify that data sheets are current before placing orders. Information furnished by Intersil is believed to be accurate and reliable. However, no responsibility is assumed by Intersil or its subsidiaries for its use; nor for any infringements of patents or other rights of third parties which may result from its use. No license is granted by implication or otherwise under any patent or patent rights of Intersil or its subsidiaries.*

For information regarding Intersil Corporation and its products, see web site <http://www.intersil.com>