

50MHz, Video Operational Amplifier

The HA-2544 is a fast, unity gain stable, monolithic op amp designed to meet the needs required for accurate reproduction of video or high speed signals. It offers high voltage gain (6kV/V) and high phase margin (65 degrees) while maintaining tight gain flatness over the video bandwidth. Built from high quality Dielectric Isolation, the HA-2544 is another addition to the Intersil series of high speed, wideband op amps, and offers true video performance combined with the versatility of an op amp.

The primary features of the HA-2544 include 50MHz Gain Bandwidth, 150V/μs slew rate, 0.03% differential gain error and gain flatness of just 0.12dB at 10MHz. High performance and low power requirements are met with a supply current of only 10mA.

Uses of the HA-2544 range from video test equipment, guidance systems, radar displays and other precise imaging systems where stringent gain and phase requirements have previously been met with costly hybrids and discrete circuitry. The HA-2544 will also be used in non-video systems requiring high speed signal conditioning such as data acquisition systems, medical electronics, specialized instrumentation and communication systems.

Military (/883) product and data sheets are available upon request.

Ordering Information

PART NUMBER (BRAND)	TEMP. RANGE (°C)	PACKAGE	PKG. NO.
HA3-2544C-5	0 to 75	8 Ld PDIP	E8.3
HA7-2544-2	-55 to 125	8 Ld CERDIP	F8.3A

Features

- Gain Bandwidth 50MHz
- High Slew Rate 150V/μs
- Low Supply Current 10mA
- Differential Gain Error 0.03%
- Differential Phase Error 0.03 Degrees
- Gain Flatness at 10MHz 0.12dB

Applications

- Video Systems
- Video Test Equipment
- Radar Displays
- Data Acquisition Systems
- Imaging Systems
- Pulse Amplifiers
- Signal Conditioning Circuits

Pinout

**HA-2544 (CERDIP)
HA-2544C (PDIP)
TOP VIEW**

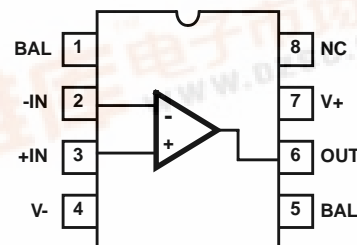

HA-2544

Absolute Maximum Ratings

Voltage Between V+ and V- Terminals	35V
Differential Input Voltage (Note 1)	6V
Peak Output Current	±40mA

Operating Conditions

Temperature Range	
HA-2544C-5	0°C to 75°C
HA-2544-2	-55°C to 125°C

Thermal Information

Thermal Resistance (Typical, Note 2)	θ_{JA} (°C/W)	θ_{JC} (°C/W)
PDIP Package	92	N/A
CERDIP Package	135	50
Maximum Junction Temperature (Hermetic Packages)	175°C	
Maximum Junction Temperature (Plastic Packages)	150°C	
Maximum Storage Temperature Range	-65°C to 150°C	
Maximum Lead Temperature (Soldering 10s)	300°C	

CAUTION: Stresses above those listed in "Absolute Maximum Ratings" may cause permanent damage to the device. This is a stress only rating and operation of the device at these or any other conditions above those indicated in the operational sections of this specification is not implied.

NOTES:

- To achieve optimum AC performance, the input stage was designed without protective diode clamps. Exceeding the maximum differential input voltage results in reverse breakdown of the base-emitter junction of the input transistors and probable degradation of the input parameters especially V_{OS} , I_{OS} and Noise.
- θ_{JA} is measured with the component mounted on an evaluation PC board in free air.

Electrical Specifications $V_{SUPPLY} = \pm 15V$, $C_L \leq 10pF$, $R_L = 1k\Omega$, Unless Otherwise Specified

PARAMETER	TEST CONDITIONS	TEMP (°C)	HA-2544-2			HA-2544C-5			UNITS
			MIN	TYP	MAX	MIN	TYP	MAX	
INPUT CHARACTERISTICS									
Offset Voltage		25	-	6	15	-	15	25	mV
		-2, -5	-	-	20	-	-	40	mV
		-9	-	-	25	-	-	40	mV
Average Offset Voltage Drift (Note 7)		Full	-	10	-	-	10	-	$\mu V/^\circ C$
Bias Current		25	-	7	15	-	9	18	μA
		Full	-	-	20	-	-	30	μA
Average Bias Current Drift (Note 7)		Full	-	0.04	-	-	0.04	-	$\mu A/^\circ C$
Offset Current		25	-	0.2	2	-	0.8	2	μA
		Full	-	-	3	-	-	3	μA
Offset Current Drift		Full	-	10	-	-	10	-	$nA/^\circ C$
Common Mode Range		Full	±10	±11.5	-	±10	±11.5	-	V
Differential Input Resistance		25	50	90	-	50	90	-	k Ω
Differential Input Capacitance		25	-	3	-	-	3	-	pF
Input Noise Voltage	f = 1kHz	25	-	20	-	-	20	-	nV/\sqrt{Hz}
Input Noise Current	f = 1kHz	25	-	2.4	-	-	2.4	-	pA/\sqrt{Hz}
Input Noise Voltage (Note 7)	0.1Hz to 10Hz	25	-	1.5	-	-	1.5	-	μV_{P-P}
	0.1Hz to 1MHz	25	-	4.6	-	-	4.6	-	μV_{RMS}
TRANSFER CHARACTERISTICS									
Large Signal Voltage Gain (Note 7)	$V_O = \pm 5V$	25	3.5	6	-	3	6	-	kV/V
		Full	2.5	-	-	2	-	-	kV/V
Common Mode Rejection Ratio (Note 7)	$\Delta V_{CM} = \pm 10V$	-2, -5	75	89	-	70	89	-	dB
		-9	75	89	-	65	89	-	dB
Minimum Stable Gain		25	+1	-	-	+1	-	-	V/V
Unity Gain Bandwidth (Note 7)	$V_O = \pm 100mV$	25	-	45	-	-	45	-	MHz
Gain Bandwidth Product (Note 7)	$V_O = \pm 100mV$	25	-	50	-	-	50	-	MHz

HA-2544

Electrical Specifications $V_{SUPPLY} = \pm 15V$, $C_L \leq 10pF$, $R_L = 1k\Omega$, Unless Otherwise Specified (Continued)

PARAMETER	TEST CONDITIONS	TEMP (°C)	HA-2544-2			HA-2544C-5			UNITS
			MIN	TYP	MAX	MIN	TYP	MAX	
Phase Margin		25	-	65	-	-	65	-	Degrees
OUTPUT CHARACTERISTICS									
Output Voltage Swing		Full	±10	±11	-	±10	±11	-	V
Full Power Bandwidth (Note 6)		25	3.2	4.2	-	3.2	4.2	-	MHz
Peak Output Current (Note 7)		25	±25	±35	-	±25	±35	-	mA
Continuous Output Current (Note 7)		25	±10	-	-	±10	-	-	mA
Output Resistance	Open Loop	25	-	20	-	-	20	-	Ω
TRANSIENT RESPONSE									
Rise Time (Note 4)		25	-	7	-	-	7	-	ns
Overshoot (Note 4)		25	-	10	-	-	10	-	%
Slew Rate		25	100	150	-	100	150	-	V/μs
Settling Time (Note 5)		25	-	120	-	-	120	-	ns
VIDEO PARAMETERS $R_L = 1k\Omega$ (Note 8)									
Differential Phase (Note 9)		25	-	0.03	-	-	0.03	-	Degree
Differential Gain (Notes 3, 9)		25	-	0.0026	-	-	0.0026	-	dB
		25	-	0.03	-	-	0.03	-	%
Gain Flatness	5MHz	25	-	0.10	-	-	0.10	-	dB
	10MHz	25	-	0.12	-	-	0.12	-	dB
Chrominance to Luminance Gain (Note 10)		25	-	0.1	-	-	0.1	-	dB
Chrominance to Luminance Delay (Note 10)		25	-	7	-	-	7	-	ns
POWER SUPPLY CHARACTERISTICS									
Supply Current		Full	-	10	12	-	10	15	mA
Power Supply Rejection Ratio (Note 7)	$V_S = \pm 10V$ to $\pm 20V$	-2, -5	70	80	-	70	80	-	dB
		-9	65	80	-	65	80	-	dB

NOTES:

$$3. A_D(\%) = \left[10^{\frac{A_D(\text{dB})}{20}} - 1 \right] \times 100.$$

4. For Rise Time and Overshoot testing, V_{OUT} is measured from 0 to +200mV and 0 to -200mV.
5. Settling Time is specified to 0.1% of final value for a 10V step and $A_V = -1$.
6. Full Power Bandwidth is guaranteed by equation: Full Power Bandwidth = $\frac{\text{Slew Rate}}{2\pi V_{PEAK}}$ ($V_{PEAK} = 5V$).
7. Refer to typical performance curve in Data Sheet.
8. The video parameter specifications will degrade as the output load resistance decreases.
9. Tested with a VM700A video tester, using a NTC-7 Composite input signal. For adequate test repeatability, a minimum warm-up of 2 minutes is suggested. $A_V = +1$.
10. C-L Gain and C-L Delay was less than the resolution of the test equipment used which is 0.1dB and 7ns, respectively.

Test Circuits and Waveforms

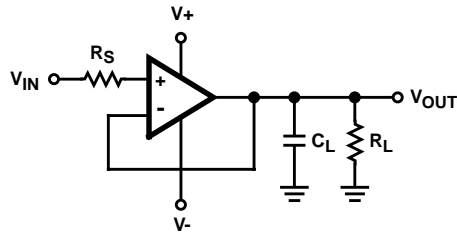

- NOTES:
11. $V_S = \pm 15V$.
 12. $A_V = +1$.
 13. $R_S = 50\Omega$ or 75Ω (Optional).
 14. $R_L = 1k\Omega$.
 15. $C_L < 10pF$.
 16. V_{IN} for Large Signal = $\pm 5V$.
 17. V_{IN} for Small Signal = 0 to $+200mV$ and 0 to $-200mV$.

FIGURE 1. TRANSIENT RESPONSE

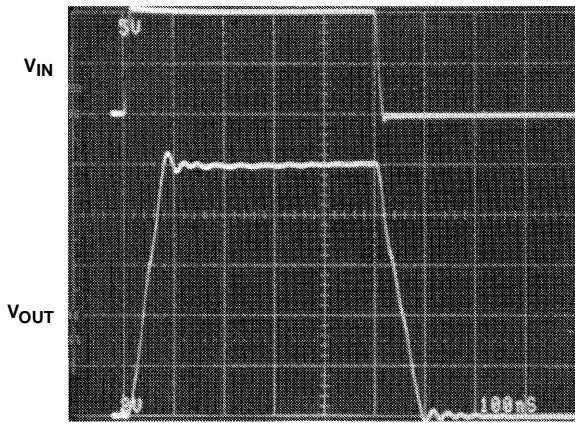

$V_{OUT} = 0$ to $+10V$
 Vertical Scale: $V_{IN} = 5V/Div.$; $V_{OUT} = 2V/Div.$
 Horizontal Scale: $100ns/Div.$

LARGE SIGNAL RESPONSE

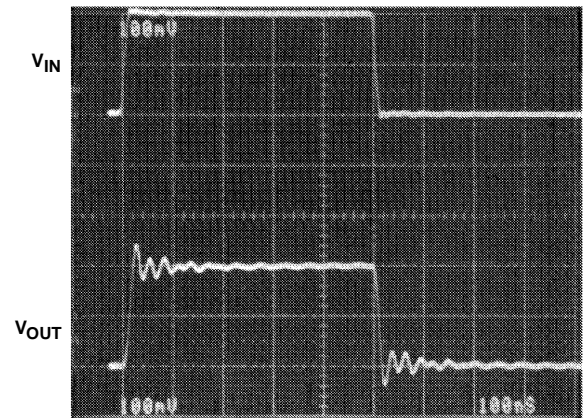

$V_{OUT} = 0$ to $+200mV$
 Vertical Scale: $V_{IN} = 100mV/Div.$; $V_{OUT} = 100mV/Div.$
 Horizontal Scale: $100ns/Div.$

SMALL SIGNAL RESPONSE

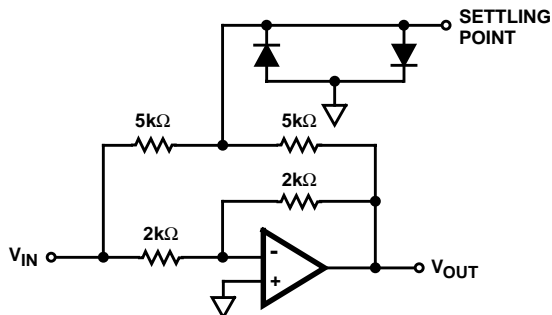

- NOTES:
18. $A_V = -1$.
 19. Feedback and summing resistor ratios should be 0.1% matched.
 20. HP5082-2810 clipping diodes recommended.
 21. Tektronix P6201 FET probe used at settling point.

FIGURE 2. SETTLING TIME TEST CIRCUIT

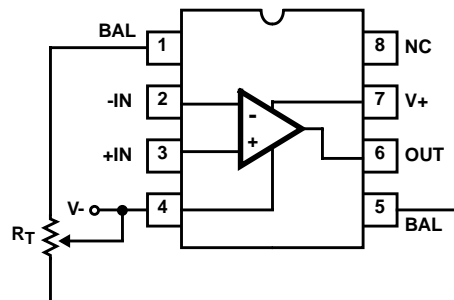

NOTE: Tested offset adjustment range is $|V_{OS} + 1mV|$ minimum referred to output. Typical range for $R_T = 20k\Omega$ is approximately $\pm 30mV$.

FIGURE 3. OFFSET VOLTAGE ADJUSTMENT

HA-2544

Schematic Diagram

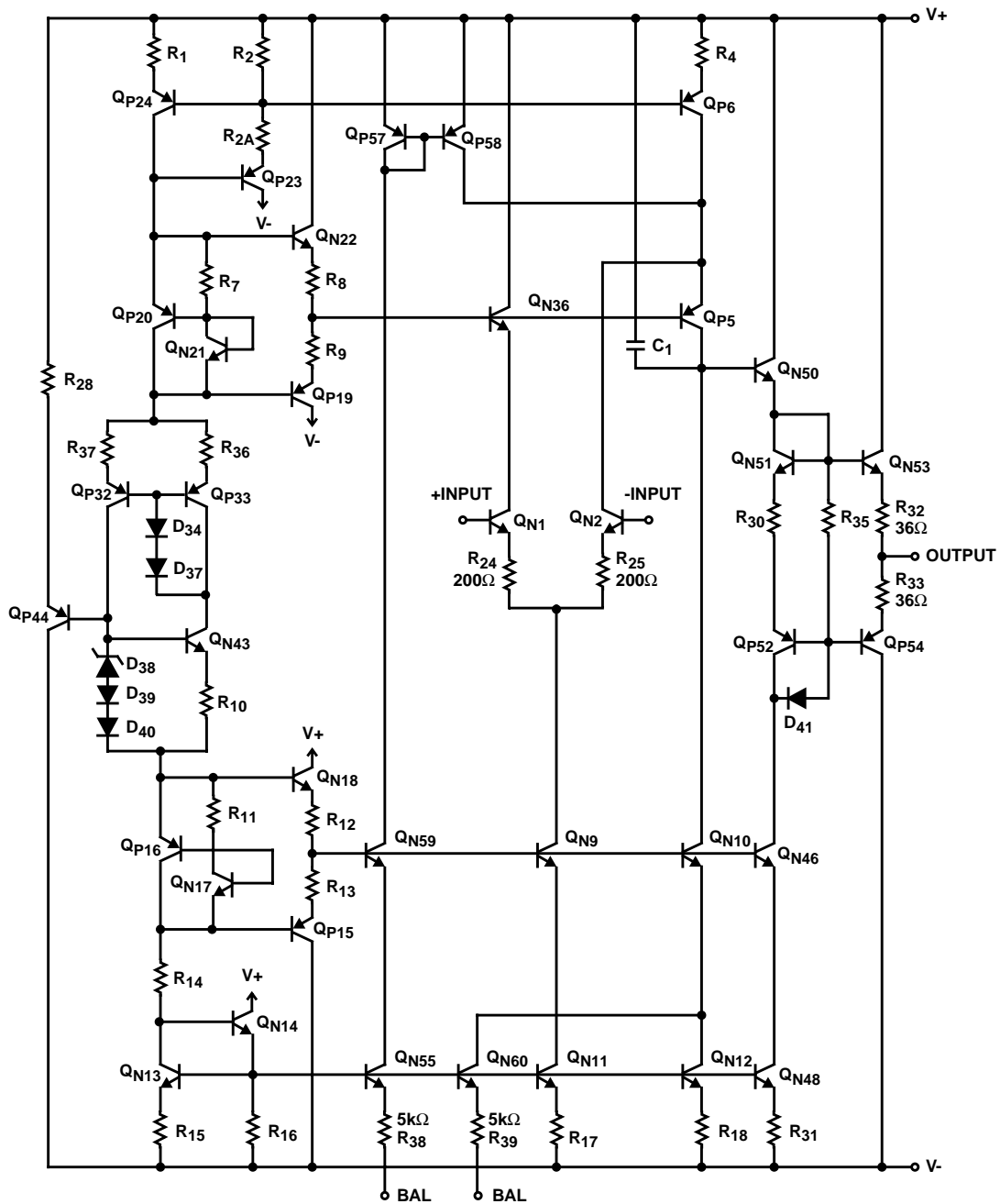

Application Information

The HA-2544 is a true differential op amp that is as versatile as any op amp but offers the advantages of high unity gain bandwidth, high speed and low supply current. More important than its general purpose applications is that the HA-2544 was especially designed to meet the requirements found in a video amplifier system. These requirements include fine picture resolution and accurate color rendition, and must meet broadcast quality standards.

In a video signal, the video information is carried in the amplitude and phase as well as in the DC level. The amplifier must pass the 30Hz line rate luminance level and the 3.58MHz

(NTSC) or 4.43MHz (PAL) color band without altering phase or gain. The HA-2544's key specifications aimed at meeting this include high bandwidth (50MHz), very low gain flatness (0.12dB at 10MHz), near unmeasurable differential gain and differential phase (0.03% and 0.03 degrees), and low noise ($20nV/\sqrt{Hz}$). The HA-2544 meets these guidelines.

The HA-2544 also offers the advantage of a full output voltage swing of $\pm 10V$ into a $1k\Omega$ load. This equates to a full power bandwidth of 2.4MHz for this $\pm 10V$ signal. If video signal levels of $\pm 2V$ maximum is used (with $R_L = 1k\Omega$), the full power bandwidth would be 11.9MHz without clipping distortion.

HA-2544

Another usage might be required for a direct 50Ω or 75Ω load where the HA-2544 will still swing this ±2V signal as shown in the above display. One important note that must be realized is that as load resistance decreases the video parameters are also degraded. For optimal video performance a 1kΩ load is recommended.

If lower supply voltages are required, such as ±5V, many of the characterization curves indicate where the parameters vary. As shown the bandwidth, slew rate and supply current are still very well maintained.

Prototyping and PC Board Layout

When designing with the HA-2544 video op amp as with any high performance device, care should be taken to use high frequency layout techniques to avoid unwanted parasitic effects. Short lead lengths, low source impedance and lower value feedback resistors help reduce unwanted poles or zeros. This layout would also include ground plane construction and power supply decoupling as close to the supply pins with suggested parallel capacitors of 0.1μF and 0.001μF ceramic to ground.

In the noninverting configuration, the amplifier is sensitive to stray capacitance (<40pF) to ground at the inverting input. Therefore, the inverting node connections should be kept to a minimum. Phase shift will also be introduced as load parasitic capacitance is increased. A small series

resistor (20Ω to 100Ω) before the capacitance effectively decouples this effect.

Stability/Phase Margin/Compensation

The HA-2544 has not sacrificed unity gain stability in achieving its superb AC performance. For this device, the phase margin exceeds 60 degrees at the unity crossing point of the open loop frequency response. Large phase margin is critical in order to reduce the differential phase and differential gain errors caused by most other op amps. Because this part is unity gain stable, no compensation pin is brought out. If compensation is desired to reduce the noise bandwidth, most standard methods may be used. One method suggested for an inverting scheme would be a series R-C from the inverting node to ground which will reduce bandwidth, but not effect slew rate. If the user wishes to achieve even higher bandwidth (>50MHz), and can tolerate some slight gain peaking and lower phase margin, experimenting with various load capacitance can be done.

Shown in Application 1 is an excellent Differential Input, Unity Gain Buffer which also will terminate a cable to 75Ω and reject common mode voltages. Application 2 is a method of separating a video signal up into the Sync only signal and the Video and Blanking signal. Application 3 shows the HA-2544 being used as a 100kHz High Pass 2-Pole Butterworth Filter. Also shown is the measured frequency response curves.

Typical Applications

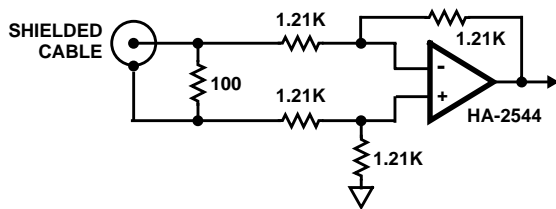

FIGURE 4. APPLICATION 1, 75Ω DIFFERENTIAL INPUT BUFFER

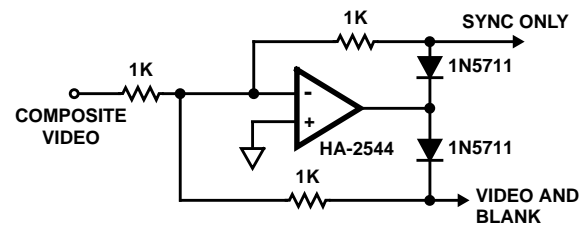

FIGURE 5. APPLICATION 2, COMPOSITE VIDEO SYNC SEPARATOR

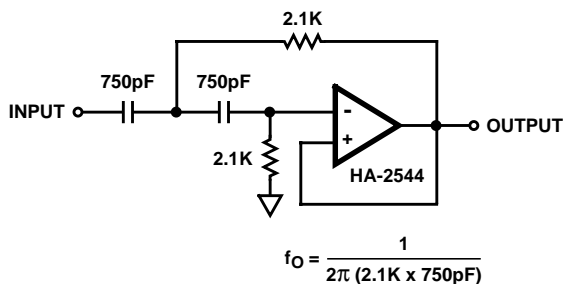

FIGURE 6. APPLICATION 3, 100kHz HIGH PASS 2-POLE BUTTERWORTH FILTER

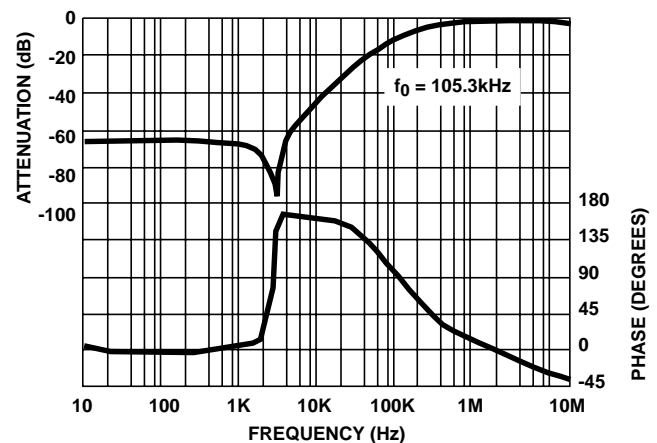

FIGURE 7. MEASURED FREQUENCY RESPONSE OF APPLICATION 3

Typical Performance Curves

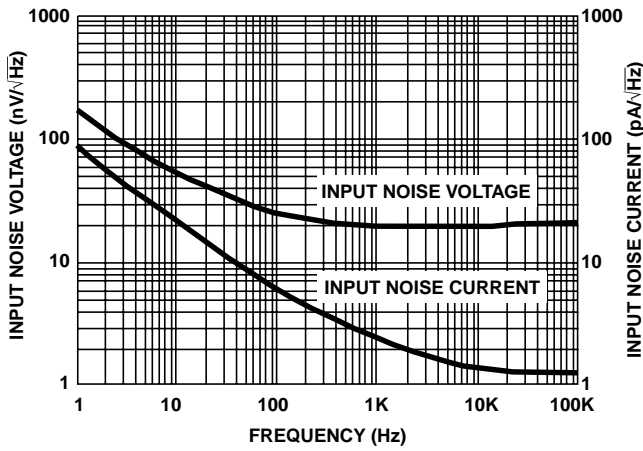

FIGURE 8. INPUT NOISE VOLTAGE AND NOISE CURRENT vs FREQUENCY

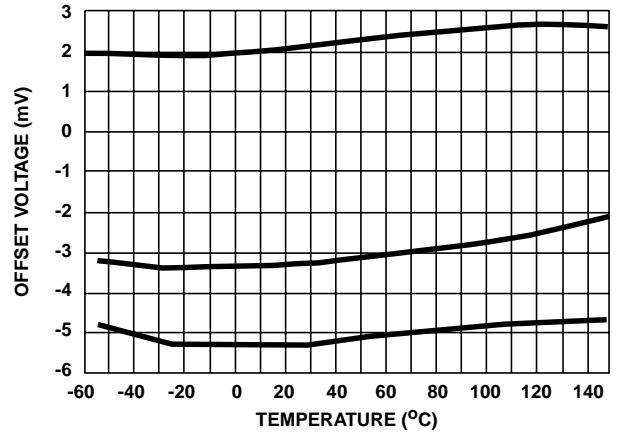
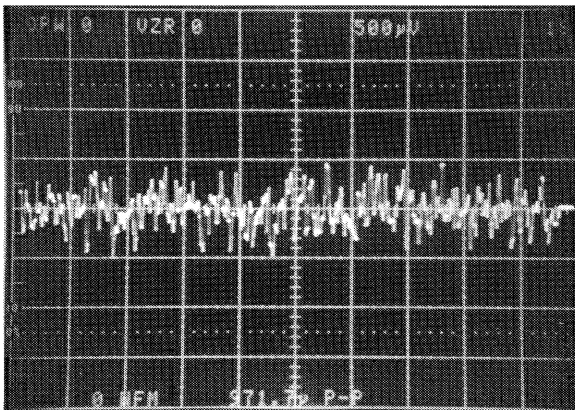

FIGURE 9. INPUT OFFSET VOLTAGE vs TEMPERATURE (3 TYPICAL UNITS)



0.1Hz to 10Hz, Noise Voltage = 0.97 μ V_{p-p}
 FIGURE 10. NOISE VOLTAGE ($A_V = 1000$)

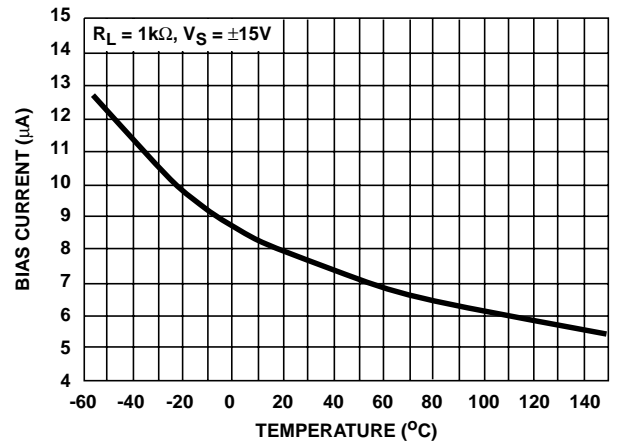

FIGURE 11. INPUT BIAS CURRENT vs TEMPERATURE

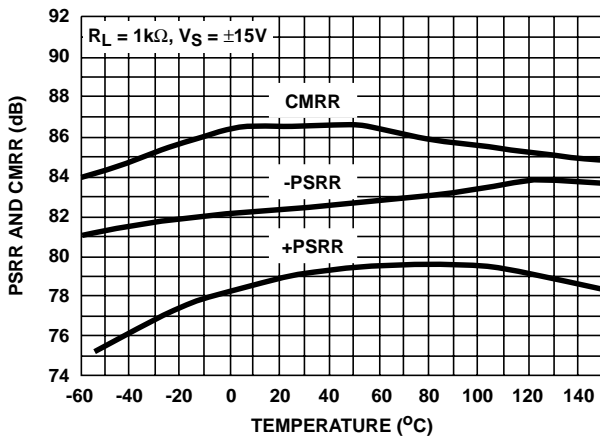

FIGURE 12. PSRR AND CMRR vs TEMPERATURE

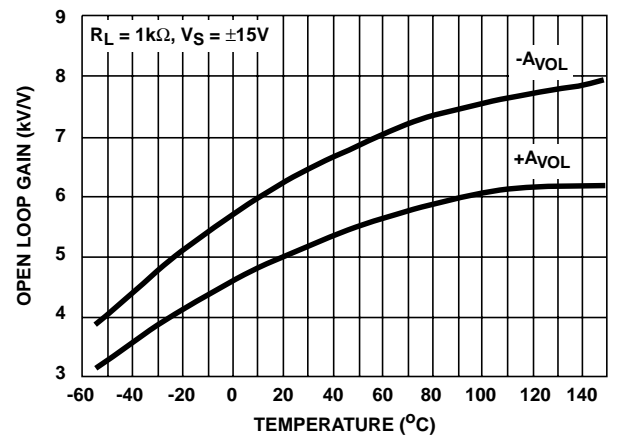

FIGURE 13. OPEN LOOP GAIN vs TEMPERATURE

Typical Performance Curves (Continued)

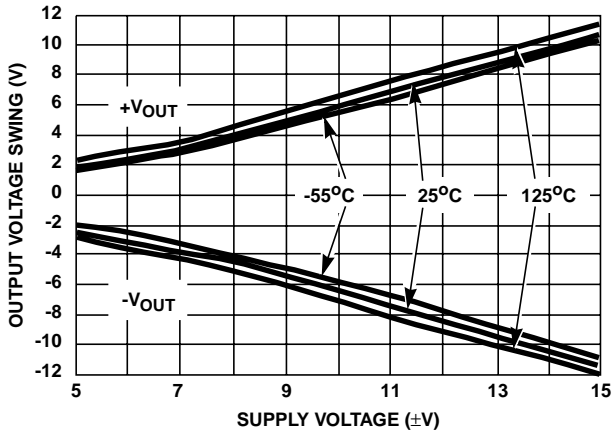

FIGURE 14. OUTPUT VOLTAGE SWING vs SUPPLY VOLTAGE

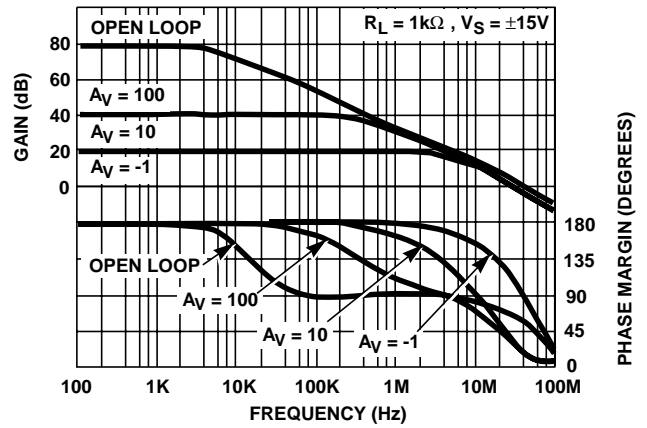

FIGURE 15. FREQUENCY RESPONSE AT VARIOUS GAINS

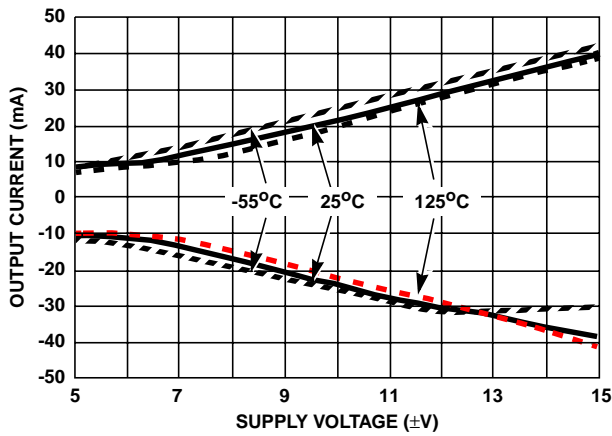

FIGURE 16. OUTPUT CURRENT vs SUPPLY VOLTAGE

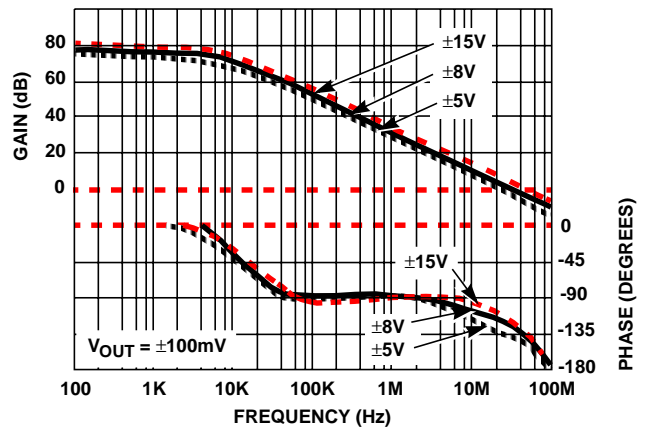

FIGURE 17. OPEN LOOP RESPONSE

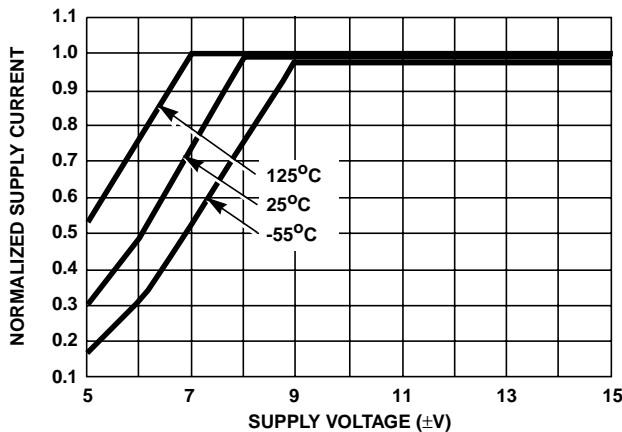

FIGURE 18. SUPPLY CURRENT vs SUPPLY VOLTAGE (NORMALIZED TO $V_S = \pm 15V$ AT $25^\circ C$)

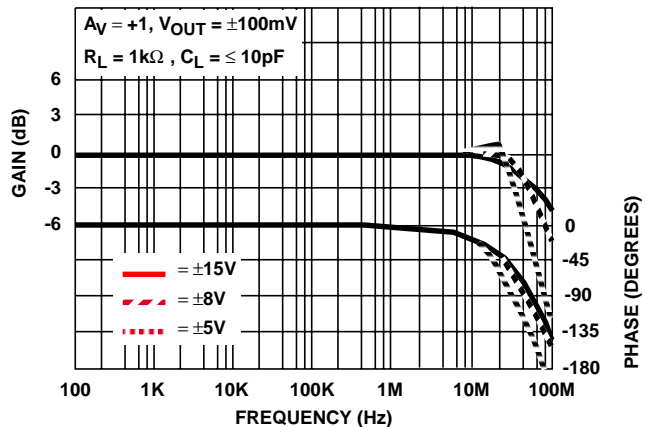

FIGURE 19. VOLTAGE FOLLOWER RESPONSE

Typical Video Performance Curves

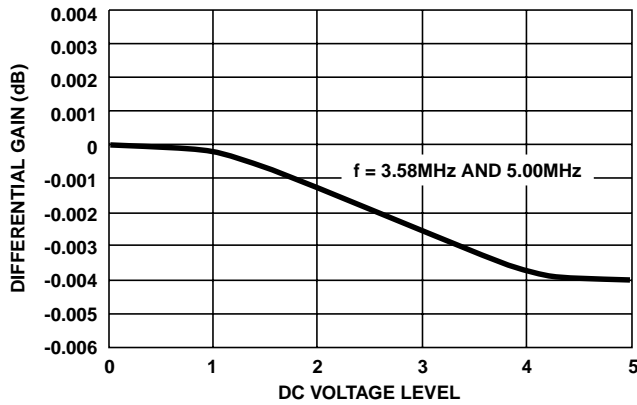

FIGURE 20. AC GAIN VARIATION vs DC OFFSET LEVELS (DIFFERENTIAL GAIN)

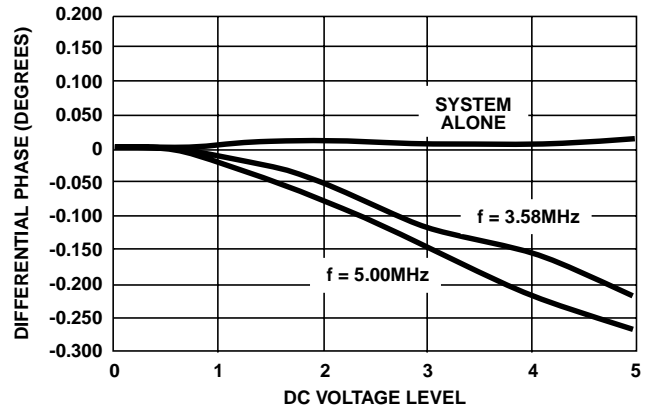
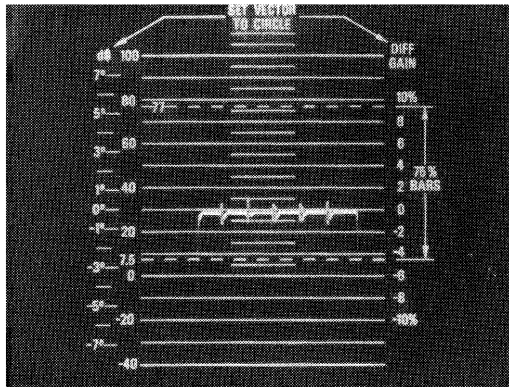
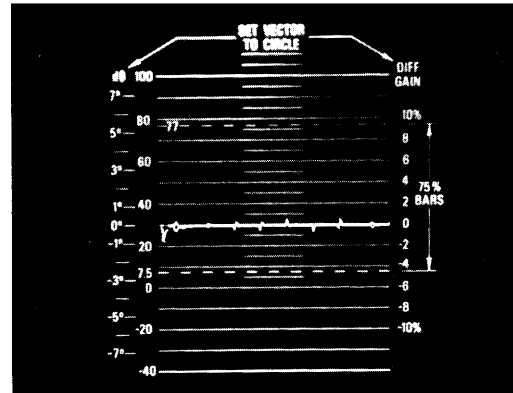

FIGURE 21. AC PHASE VARIATION vs DC OFFSET LEVELS (DIFFERENTIAL PHASE)



NTSC Method, $R_L = 1k\Omega$, Differential Gain $< 0.05\%$ at $T_A = 75^\circ C$
No Visual Difference at $T_A = -55^\circ C$ or $125^\circ C$

FIGURE 22. DIFFERENTIAL GAIN



NTSC Method, $R_L = 1k\Omega$,
Differential Phase < 0.05 Degree at $T_A = 75^\circ C$
No Visual Difference at $T_A = -55^\circ C$ or $125^\circ C$

FIGURE 23. DIFFERENTIAL PHASE

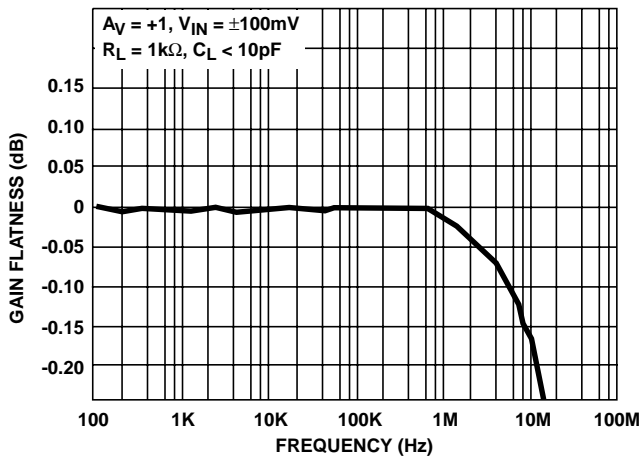
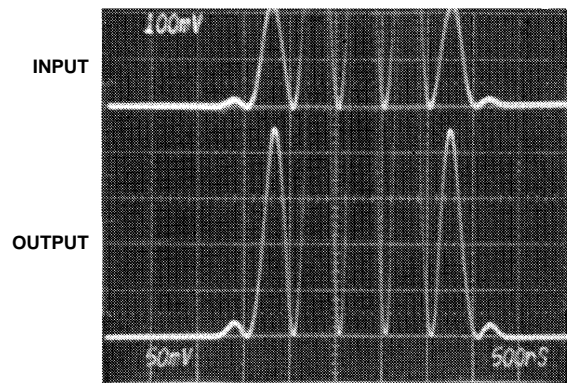

FIGURE 24. GAIN FLATNESS



NTSC Method, $R_L = 1k\Omega$, C-L Delay $< 7ns$ at $T_A = 75^\circ C$
No Visual Difference at $T_A = -55^\circ C$ or $125^\circ C$
Vertical Scale: Input = 100mV/Div., Output = 50mV/Div.
Horizontal Scale: 500ns/Div.

FIGURE 25. CHROMINANCE TO LUMINANCE DELAY

Typical Video Performance Curves (Continued)

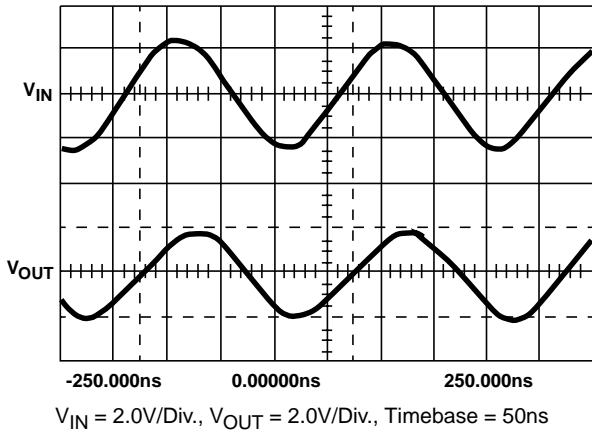

FIGURE 26. ±2V OUTPUT SWING (WITH $R_{LOAD} = 75\Omega$, FREQUENCY = 5.00MHz)

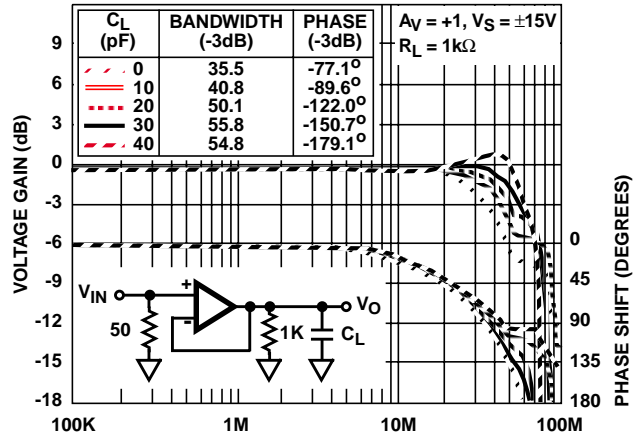

FIGURE 27. BANDWIDTH vs LOAD CAPACITANCE

Die Characteristics

DIE DIMENSIONS:

80 mils x 64 mils x 19 mils
2030 μ m x 1630 μ m x 483 μ m

METALLIZATION:

Type: Al, 1% Cu
Thickness: 16k Å ± 2k Å

PASSIVATION:

Type: Nitride (Si_3N_4) over Silox (SiO_2 , 5% Phos.)
Silox Thickness: 12k Å ± 2k Å
Nitride Thickness: 3.5k Å ± 1.5k Å

SUBSTRATE POTENTIAL (POWERED UP):

V-

TRANSISTOR COUNT:

44

PROCESS:

Bipolar Dielectric Isolation

Metallization Mask Layout

HA-2544

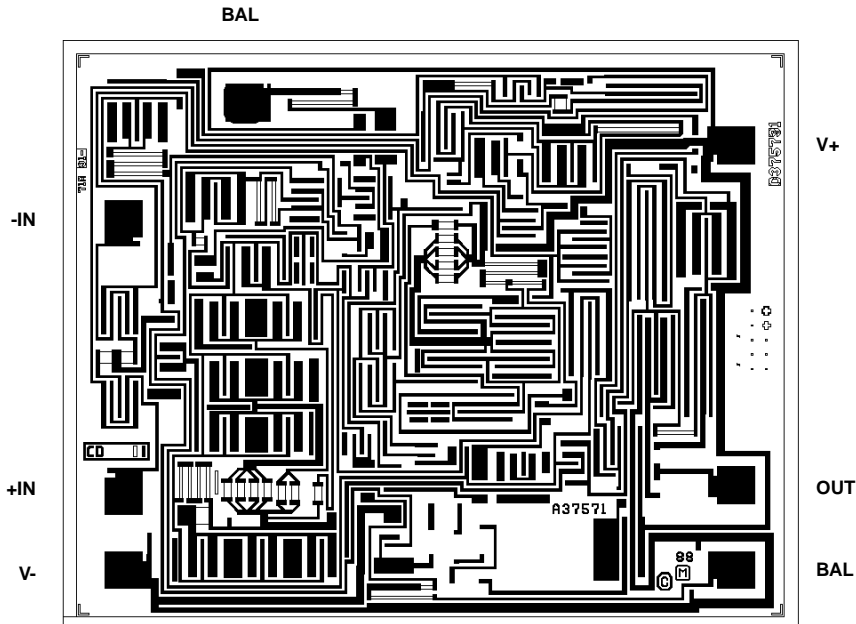

All Intersil semiconductor products are manufactured, assembled and tested under **ISO9000** quality systems certification.

Intersil semiconductor products are sold by description only. Intersil Corporation reserves the right to make changes in circuit design and/or specifications at any time without notice. Accordingly, the reader is cautioned to verify that data sheets are current before placing orders. Information furnished by Intersil is believed to be accurate and reliable. However, no responsibility is assumed by Intersil or its subsidiaries for its use; nor for any infringements of patents or other rights of third parties which may result from its use. No license is granted by implication or otherwise under any patent or patent rights of Intersil or its subsidiaries.

For information regarding Intersil Corporation and its products, see web site **www.intersil.com**

Sales Office Headquarters

NORTH AMERICA

Intersil Corporation
P. O. Box 883, Mail Stop 53-204
Melbourne, FL 32902
TEL: (321) 724-7000
FAX: (321) 724-7240

EUROPE

Intersil SA
Mercure Center
100, Rue de la Fusee
1130 Brussels, Belgium
TEL: (32) 2.724.2111
FAX: (32) 2.724.22.05

ASIA

Intersil (Taiwan) Ltd.
7F-6, No. 101 Fu Hsing North Road
Taipei, Taiwan
Republic of China
TEL: (886) 2 2716 9310
FAX: (886) 2 2715 3029