

OBSOLETE PRODUCT
 No Recommended Replacement
 contact our Technical Support Center at
 1-888-INTERSIL or www.intersil.com/tsc

150MHz, High Slew Rate, Precision Operational Amplifier

The HA-2548 is an op amp that offers a unique combination of bandwidth, slew rate, and precision specifications. These features can eliminate the need for composite op amp designs and external calibration circuitry.

Optimized for gains ≥ 5 , the HA-2548 has a gain-bandwidth product of 150MHz and a slew rate of 120V/ μ s while maintaining extremely high open loop gain (130dB Typ) and low offset voltage (300 μ V Typ). These specifications are achieved through uniquely designed input circuitry and a single ultra-high gain stage that minimizes the AC signal path. Capable of delivering over 30mA of output current, the HA-2548 is ideal for precision, high speed applications such as signal conditioning, instrumentation, video/pulse amplifiers and buffers.

For information on the military version of this device please refer to the HA-2548/883 datasheet.

Features

- High Slew Rate 120V/ μ s
- Low Offset Voltage 300 μ V
- High Open Loop Gain 130dB
- Gain Bandwidth Product 150MHz
- Low Noise Voltage at 1kHz 8.3nV/ $\sqrt{\text{Hz}}$
- Minimum Gain Stability ≥ 5

Applications

- High Speed Instrumentation
- Data Acquisition Systems
- Analog Signal Conditioning
- Precision, Wideband Amplifiers
 - Pulse/RF Amplifiers

Part Number Information

PART NUMBER	TEMP. RANGE (°C)	PACKAGE	PKG. NO.
HA2-2548-5	0 to 75	8 Pin Metal Can	T8.C
HA2-2548-9	-40 to 85	8 Pin Metal Can	T8.C
HA3-2548-5	0 to 75	8 Ld PDIP	E8.3
HA7-2548-5	0 to 75	8 Ld SBDIP	D8.3
HA9P2548-5	0 to 75	16 Ld SOIC	M16.3

Pinouts

HA-2548 (PDIP, SBDIP) TOP VIEW

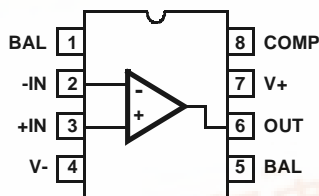

HA-2548 (METAL CAN) TOP VIEW

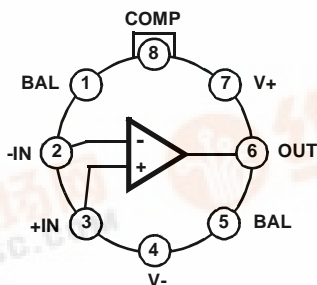

HA-2548 (SOIC) TOP VIEW

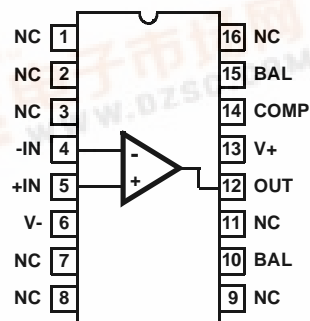

HA-2548

Absolute Maximum Ratings

Supply Voltage Between V+ and V- Terminals	40V
Differential Input Voltage	5V
Output Current	40mA

Operating Conditions

Temperature Range	
HA-2548-5	0°C to 75°C
HA-2548-9	-40°C to 85°C

Thermal Information

Thermal Resistance (Typical, Note 1)	θ_{JA} (°C/W)	θ_{JC} (°C/W)
SBDIP Package	110	30
PDIP Package	92	N/A
SOIC Package	96	N/A
Metal Can Package	165	80
Maximum Junction Temperature (Hermetic Packages)	175°C	
Maximum Junction Temperature (Plastic Package)	150°C	
Maximum Storage Temperature Range	-65°C to 150°C	
Maximum Lead Temperature (Soldering 10s)	300°C (SOIC - Lead Tips Only)	

CAUTION: Stresses above those listed in "Absolute Maximum Ratings" may cause permanent damage to the device. This is a stress only rating and operation of the device at these or any other conditions above those indicated in the operational sections of this specification is not implied.

NOTE:

- θ_{JA} is measured with the component mounted on an evaluation PC board in free air.

Electrical Specifications $V_{SUPPLY} = \pm 15V$, $R_L = 1k\Omega$, $C_L = 10pF$, Unless Otherwise Specified

PARAMETER	TEST CONDITIONS	TEMP (°C)	HA-2548-5, -9			UNITS
			MIN	TYP	MAX	
INPUT CHARACTERISTICS						
Input Offset Voltage		25	-	300	900	μV
		Full	-	400	1200	μV
Average Offset Voltage Drift (Note 5)		Full	-	4	9	$\mu V/^\circ C$
Input Bias Current		25	-	5	50	nA
		Full	-	20	100	nA
Input Offset Current		25	-	5	50	nA
		Full	-	20	100	nA
Common Mode Range		25	± 7	± 10	-	V
Differential Input Resistance		25	-	1	-	M Ω
Input Noise Voltage	f = 0.1Hz to 10Hz	25	-	0.2	-	μV_{RMS}
	f = 0.1Hz to 1MHz	25	-	0.8	-	μV_{RMS}
Input Noise Voltage Density (Note 2)	f = 10Hz	25	-	30	-	nV/ \sqrt{Hz}
	f = 100Hz	25	-	12	-	nV/ \sqrt{Hz}
	f = 1000Hz	25	-	8.3	-	nV/ \sqrt{Hz}
Input Noise Current Density (Note 2)	f = 10Hz	25	-	1.9	-	pA/ \sqrt{Hz}
	f = 100Hz	25	-	0.7	-	pA/ \sqrt{Hz}
	f = 1000Hz	25	-	0.4	-	pA/ \sqrt{Hz}
TRANSFER CHARACTERISTICS						
Large Signal Voltage Gain	$V_{OUT} = \pm 10V$	25	114	130	-	dB
		Full	108	125	-	dB
Common Mode Rejection Ratio	$V_{CM} = \pm 2V$	Full	80	90	-	dB
Gain Bandwidth Product (Note 5)	$A_V = -100$, f = 100kHz to 10MHz	25	130	150	-	MHz
		Full	110	125	-	MHz
Minimum Stable Gain		Full	5	-	-	V/V
OUTPUT CHARACTERISTICS						
Output Voltage Swing		Full	± 11	± 12	-	V
Output Current	$R_L = 1k\Omega$, $V_{OUT} \geq 10V$	Full	± 30	± 33	-	mA
Output Resistance		25	-	5	-	Ω
Full Power Bandwidth (Note 3)		25	-	1.91	-	MHz
TRANSIENT RESPONSE $A_V = +5$, Unless Otherwise Specified						

HA-2548

Electrical Specifications $V_{SUPPLY} = \pm 15V$, $R_L = 1k\Omega$, $C_L = 10pF$, Unless Otherwise Specified (Continued)

PARAMETER	TEST CONDITIONS	TEMP (°C)	HA-2548-5, -9			UNITS
			MIN	TYP	MAX	
Slew Rate (Note 5) Positive	$V_{OUT} = \pm 5V$	25	80	120	-	V/ μs
		Full	70	105	-	V/ μs
Slew Rate (Note 5) Negative	$V_{OUT} = \pm 5V$	25	70	110	-	V/ μs
		Full	60	105	-	V/ μs
Rise Time (Note 5)	$V_{OUT} = \pm 100mV$	25	-	16.5	20	ns
		Full	-	19	23	ns
Fall Time (Note 5)	$V_{OUT} = \pm 100mV$	25	-	16	20	ns
		Full	-	18	23	ns
Overshoot (Note 5) Positive	$V_{OUT} = \pm 100mV$	25	-	15	25	%
		Full	-	25	35	%
Overshoot (Note 5) Negative	$V_{OUT} = \pm 100mV$	25	-	8	15	%
		Full	-	20	30	%
Settling Time	Notes 4, 5	25	-	200	260	ns
POWER SUPPLY						
Power Supply Rejection Ratio	$V_S = \pm 10V$ to $\pm 20V$	Full	86	95	-	dB
I_{CC}		Full	-	12	18	mA

NOTES:

- Refer to typical performance curve in data sheet.
- Full Power Bandwidth is calculated by: $FPBW = \frac{\text{Slew Rate}}{2\pi V_{PEAK}}$, $V_{PEAK} = 10V$.
- Settling time is specified to 0.01% with a 10V step and $A_V = -5$.
- These parameters are not tested. The limits are guaranteed based on lab characterization and reflect lot to lot variation.

Test Circuits and Waveforms

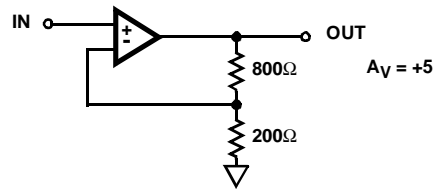
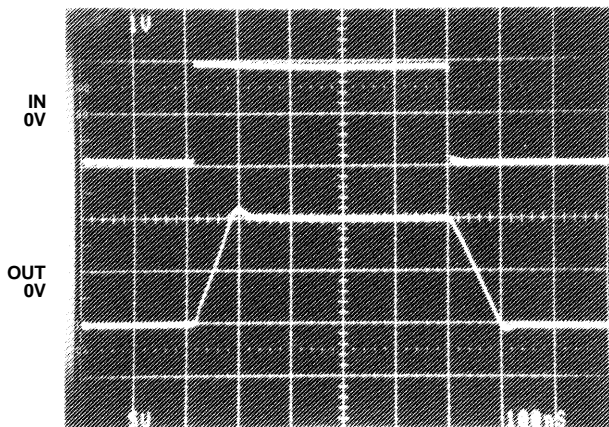
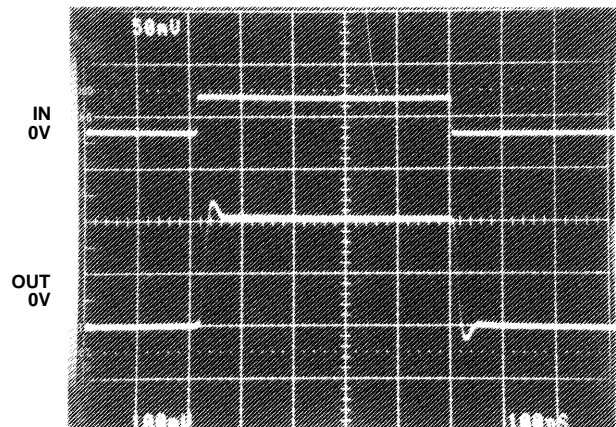

FIGURE 1. LARGE AND SMALL SIGNAL RESPONSE CIRCUIT



$V_{OUT} = \pm 5V$, $A_V = +5$, $R_L = 1K$, $C_L \leq 10pF$

FIGURE 2. LARGE SIGNAL RESPONSE



$V_{OUT} = \pm 100mV$, $A_V = +5$, $R_L = 1K$, $C_L \leq 10pF$

FIGURE 3. SMALL SIGNAL RESPONSE

Test Circuits and Waveforms (Continued)

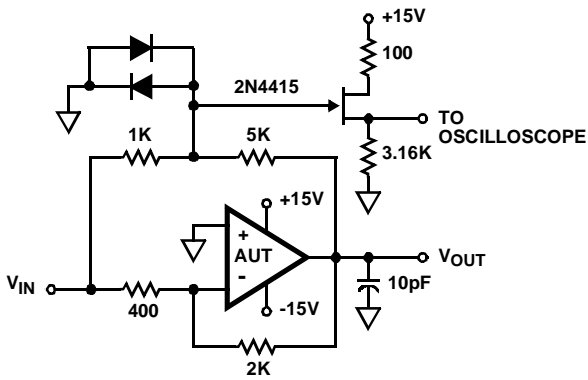

NOTES:

6. $A_V = -5$.
7. Feedback and summing resistors should be 0.1% matched.
8. Clipping diodes are optional. HP5082-2810 recommended.

FIGURE 4. SETTLING TIME TEST CIRCUIT

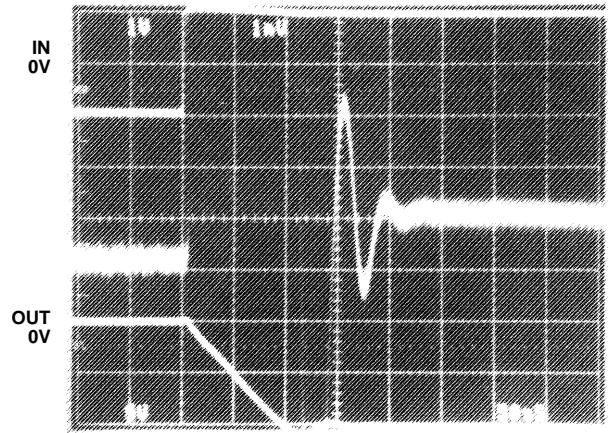

$A_V = -5$, Output = -10V Output Scale Vertical: 1mV/Div., Horizontal: 50ns/Div.

FIGURE 5. HA-2548 SETTLING TIME

Schematic Diagram

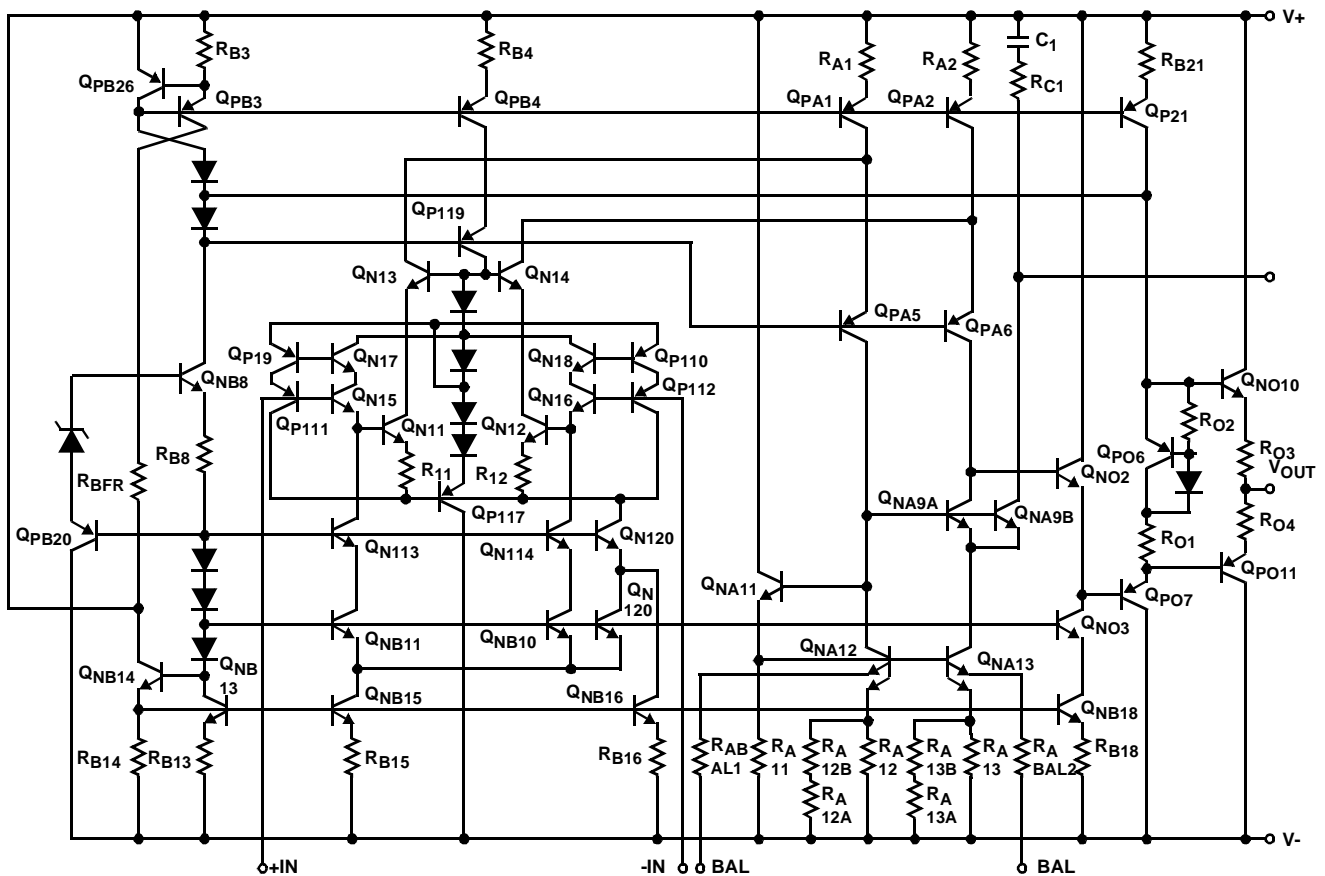

Application Information

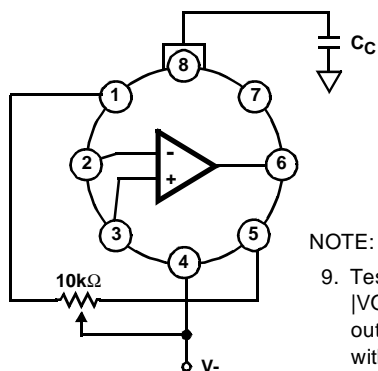

NOTE:

9. Tested Offset Adjustment Range is $|V_{OS} + 1mV|$ minimum referred to output. Typical range is $\pm 20mV$ with $R_T = 10k\Omega$.

FIGURE 6. SUGGESTED VOS ADJUSTMENT AND COMPENSATION HOOK UP

Typical Performance Curves $V_S = \pm 15V, T_A = 25^\circ C$

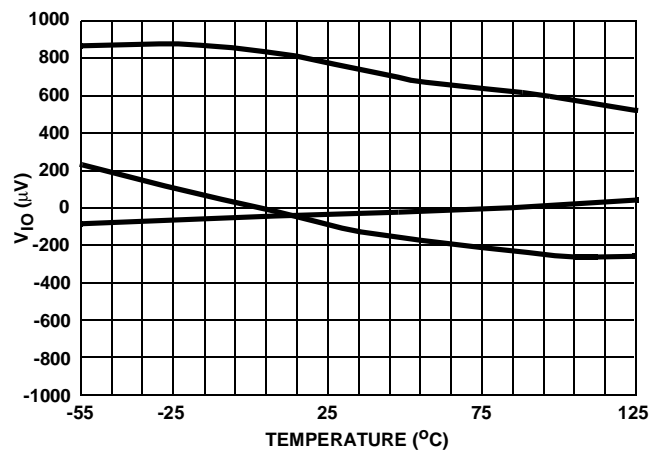

FIGURE 7. V_{IO} vs TEMPERATURE (3 REPRESENTATIVE UNITS)

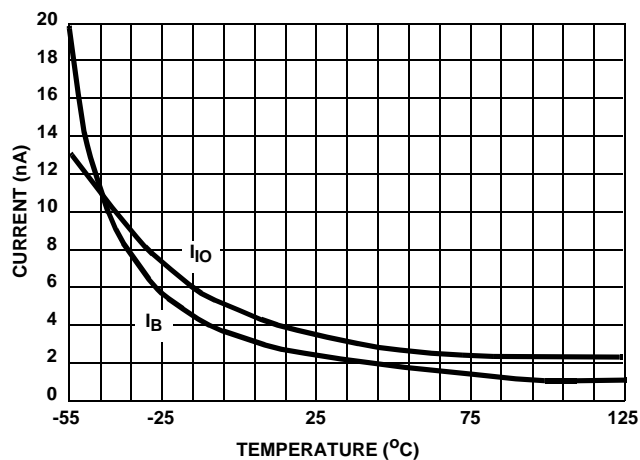

FIGURE 8. OFFSET CURRENT/BIAS CURRENT vs TEMPERATURE

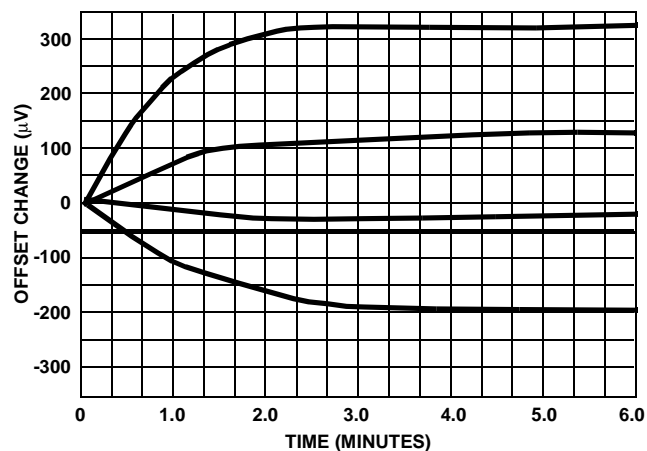

FIGURE 9. V_{IO} WARM-UP DRIFT (NORMALIZED FROM ZERO) (4 REPRESENTATIVE UNITS)

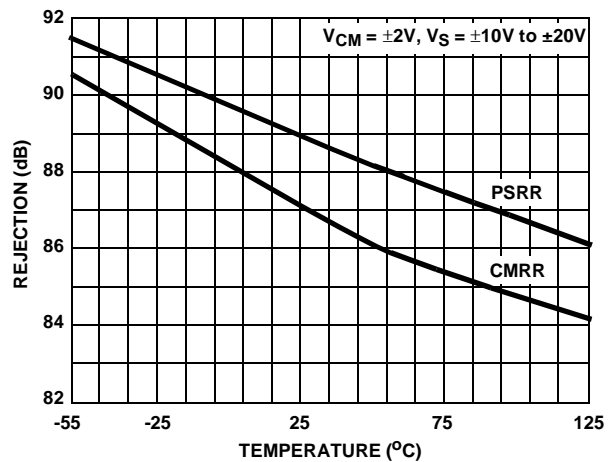

FIGURE 10. PSRR/CMRR vs TEMPERATURE

HA-2548

Typical Performance Curves $V_S = \pm 15V, T_A = 25^\circ C$ (Continued)

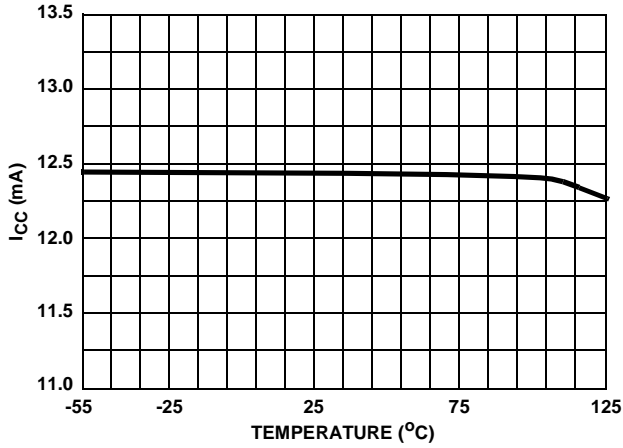

FIGURE 11. I_{CC} vs TEMPERATURE

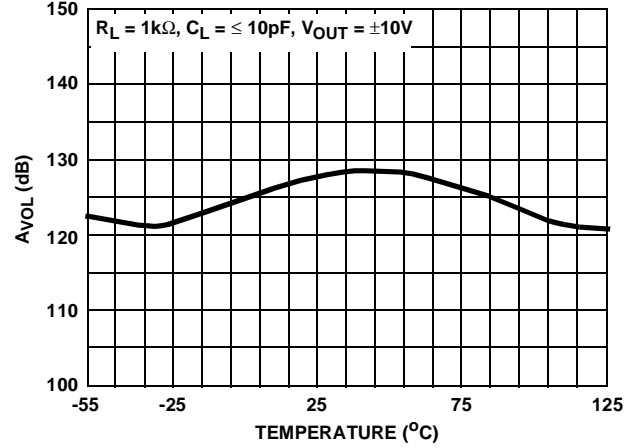

FIGURE 12. A_{VOL} vs TEMPERATURE

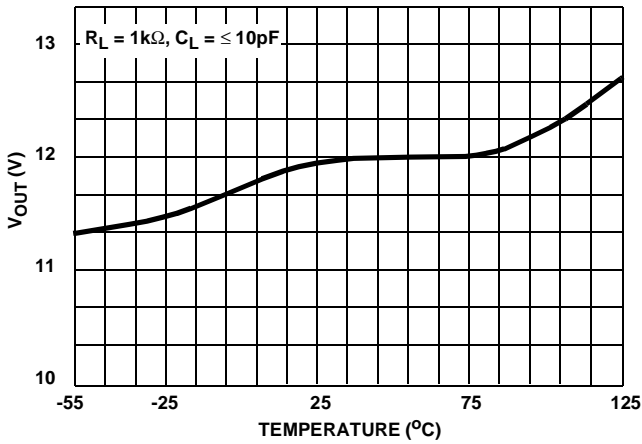

FIGURE 13. V_{OUT} vs TEMPERATURE

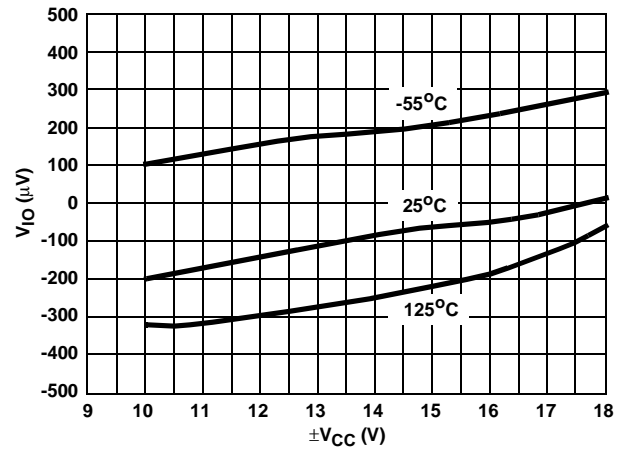

FIGURE 14. V_{IO} vs $\pm V_{CC}$ vs TEMPERATURE

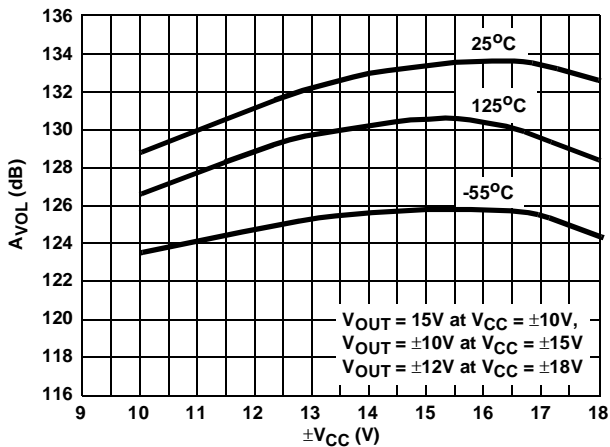

FIGURE 15. A_{VOL} vs $\pm V_{CC}$ vs TEMPERATURE

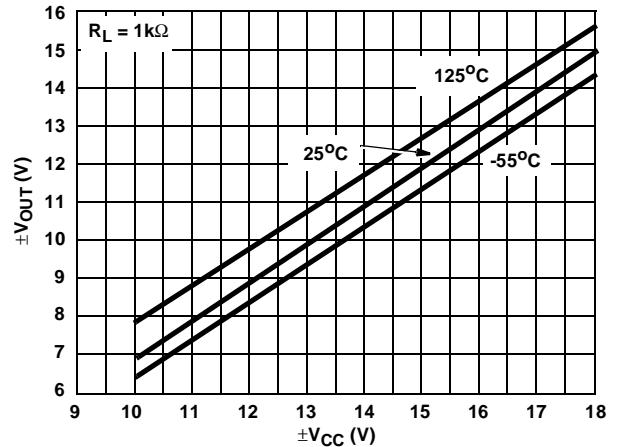

FIGURE 16. $\pm V_{OUT}$ vs $\pm V_{CC}$ vs TEMPERATURE

HA-2548

Typical Performance Curves $V_S = \pm 15V, T_A = 25^\circ C$ (Continued)

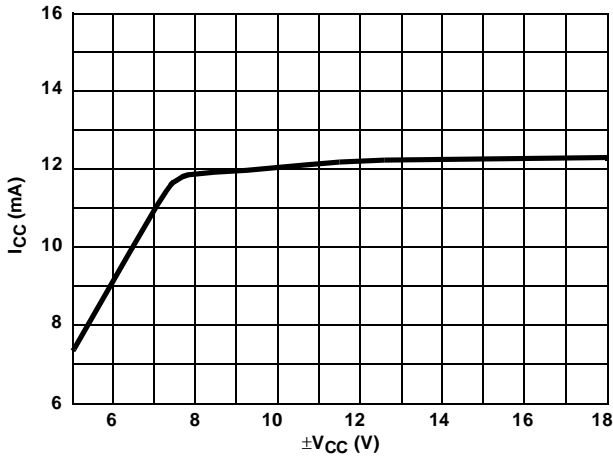

FIGURE 17. SUPPLY CURRENT vs SUPPLY VOLTAGE

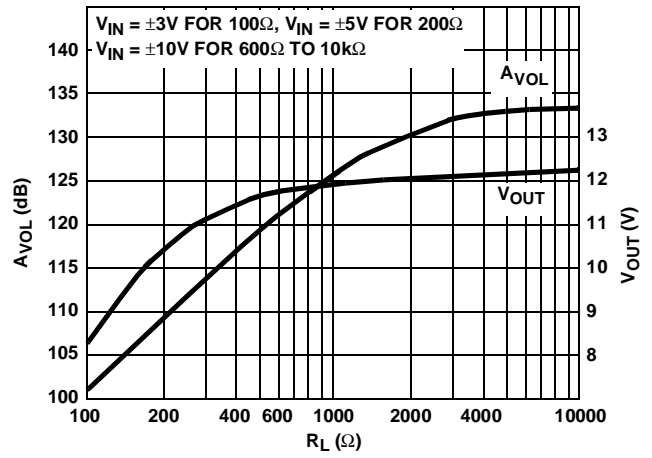

FIGURE 18. A_{VO}L/V_{OUT} vs R_L

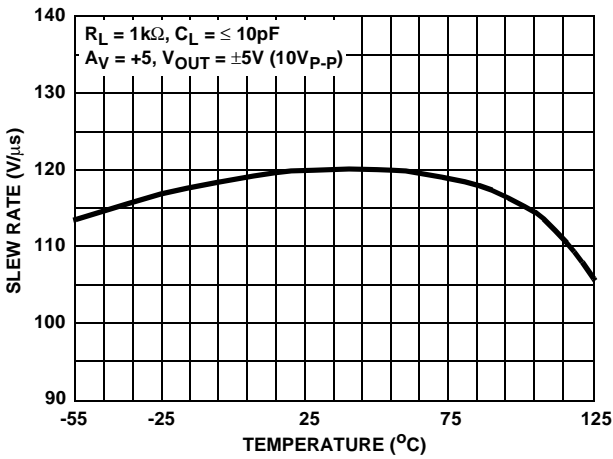

FIGURE 19. SLEW RATE vs TEMPERATURE

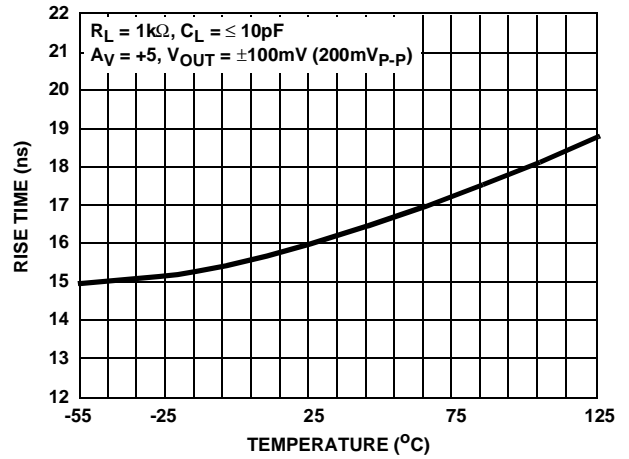

FIGURE 20. RISE TIME vs TEMPERATURE

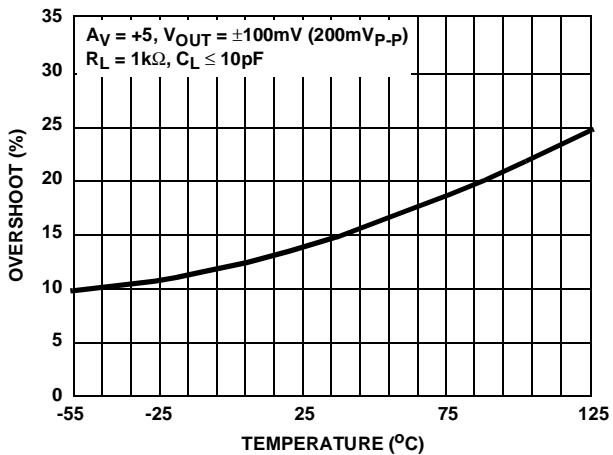

FIGURE 21. OVERSHOOT vs TEMPERATURE

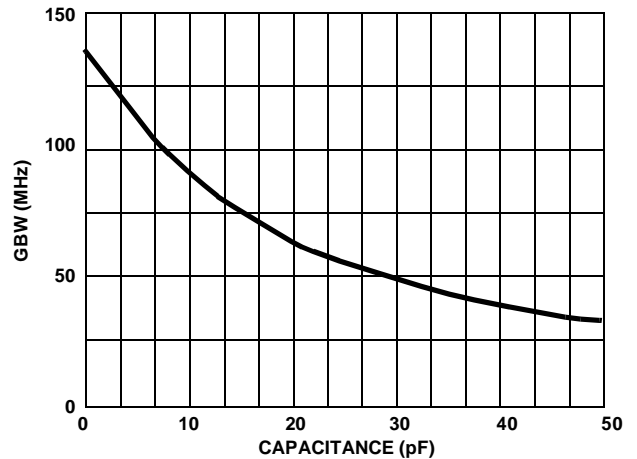

FIGURE 22. GAIN BANDWIDTH PRODUCT vs COMPENSATION CAPACITANCE TO GND

Typical Performance Curves $V_S = \pm 15V, T_A = 25^\circ C$ (Continued)

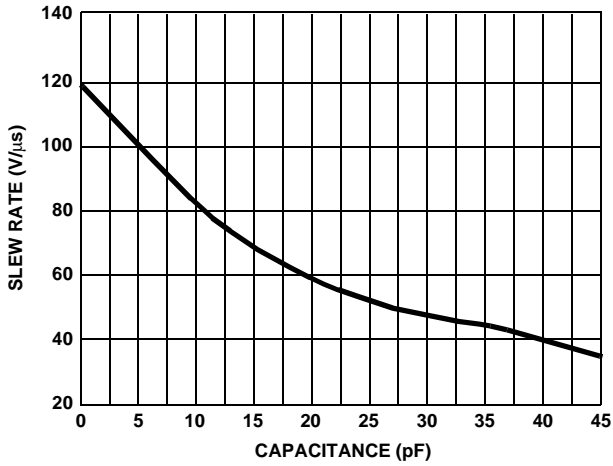

FIGURE 23. SLEW RATE vs COMPENSATION CAPACITANCE TO GND

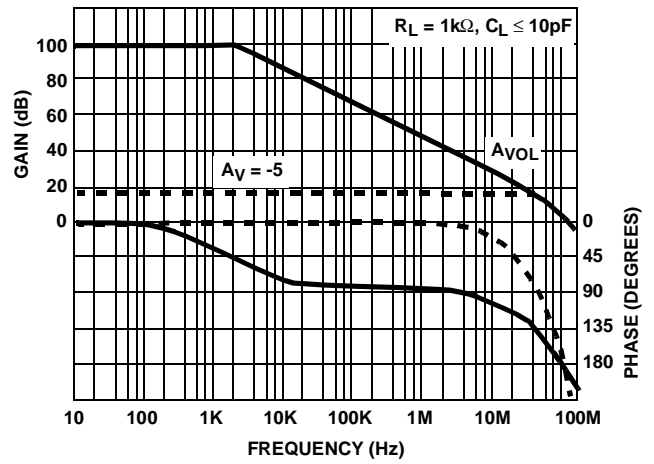

FIGURE 24. GAIN AND PHASE vs FREQUENCY

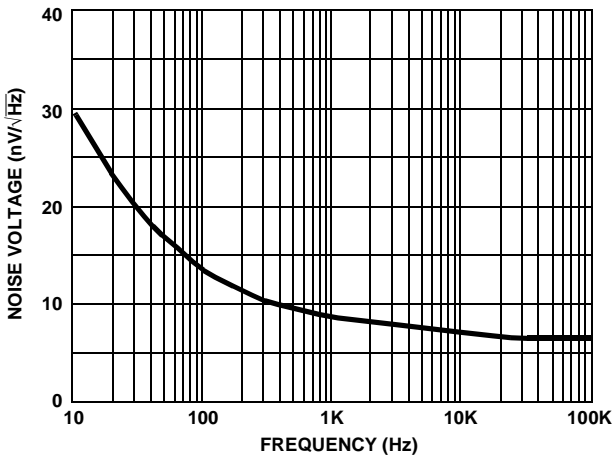

FIGURE 25. INPUT NOISE VOLTAGE DENSITY

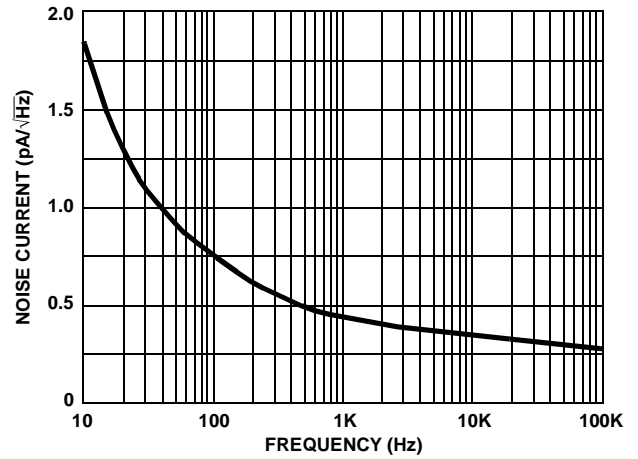
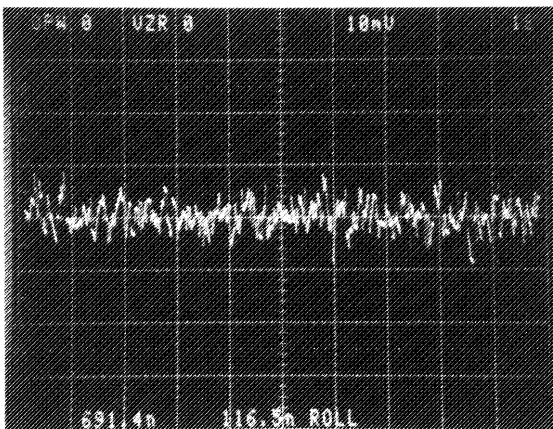
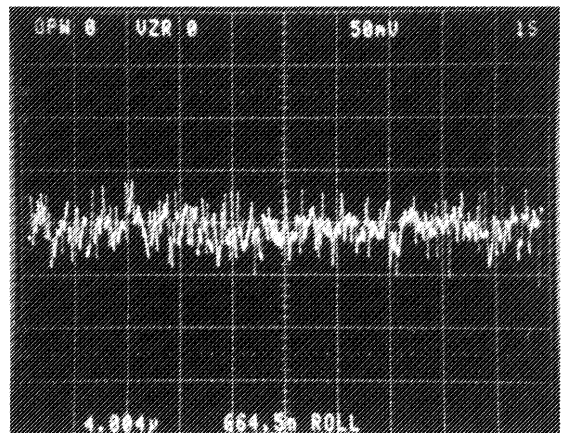

FIGURE 26. INPUT NOISE CURRENT DENSITY



P-P(RTI) = 691.4nV, RMS(RTI) = 116.5nV, $A_V = 25000$

FIGURE 27. PEAK TO PEAK NOISE 0.1Hz TO 10Hz



P-P(RTI) = 4.004 μ V, RMS(RTI) = 664.5nV, $A_V = 25000$

FIGURE 28. PEAK TO PEAK NOISE 0.1Hz TO 1MHz

HA-2548

Typical Performance Curves $V_S = \pm 15V, T_A = 25^\circ C$ (Continued)

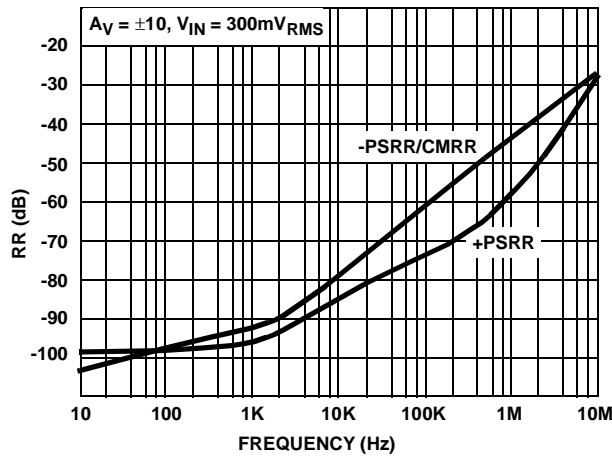

FIGURE 29. REJECTION RATIOS vs FREQUENCY

Die Characteristics

DIE DIMENSIONS:

85 mils x 91 mils x 19 mils
 2160 μm x 2320 μm x 483 μm

METALLIZATION:

Type: Aluminum, 1% Copper
 Thickness: 16k \AA \pm 2k \AA

SUBSTRATE POTENTIAL

V-

NOTE: The substrate may be left floating (Insulating Die Mount) or it may be mounted on conductor at V- potential.

PASSIVATION:

Type: Nitride over Silox
 Silox Thickness: 12k \AA \pm 2k \AA
 Nitride Thickness: 3.5k \AA \pm 1k \AA

TRANSISTOR COUNT:

60

Metallization Mask Layout

