

---

# HA12134A, HA12135A, HA12136A

Dolby B-Type Noise Reduction System

# HITACHI

ADE-207-016B (Z)

3rd Edition  
Jun. 1999

---

## Description

The HA12134A, HA12135A, HA12136A are silicon monolithic bipolar IC series providing dual channel Dolby B-type noise reduction system\* in one chip. The circuit is used primarily to reduce the level of background noise introduced during recording and playback of audio signals on magnetic tape.

HA12134A series provide the following functions and features.

## Functions

- Dual Dolby B-type NR processor
- NR ON/OFF control switch.
- Record (encode)/playback (decode) control switch.

## Features

- Separate record/playback input and output.  
Unprocessed signal output available in the encode and decode modes.
- Reduction of external components count.
- Small capacitor value for the reference voltage.
- NR ON/OFF switching and REC/PB switching are provided internally.
- 2-type package (DP-16, FP-16DA)
- Wide range of operating supply voltage.

\* Dolby is a trademark of Dolby Laboratories Licensing Corporation.  
A license from Dolby Laboratories Licensing Corporation is required for the use of this IC.

# HA12134A, HA12135A, HA12136A

## Ordering Information

Type No	Dolby Level (mVrms)	Package
HA12134A	300	DP-16
HA12134AF		FP-16DA
HA12135A	450	DP-16
HA12135AF		FP-16DA
HA12136A	580	DP-16
HA12136AF		FP-16DA

## Block Diagram

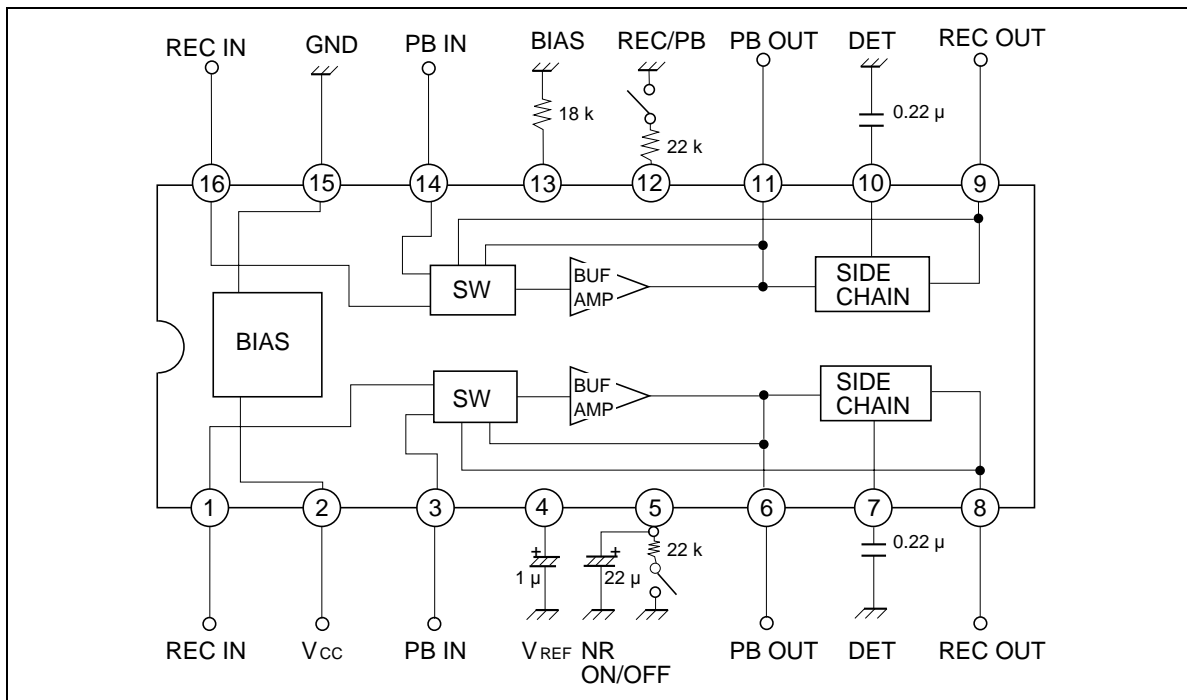

---

---

## HA12134A, HA12135A, HA12136A

---

**Absolute Maximum Ratings** (Ta = 25°C, Unless otherwise specified.)

<b>Item</b>	<b>Symbol</b>	<b>Rating</b>	<b>Unit</b>	<b>Note</b>
Supply voltage	Vccmax	16	V	
Power dissipation	Pd	250	mW	Ta ≤ 85°C
Operating temperature	Topr	-40 to +85	°C	
Storage temperature	Tstg	-55 to +125	°C	
Lead temperature	TI	260	°C	Note 1

Note: 1. Soldering 10 sec.

## HA12134A, HA12135A, HA12136A

**Electrical Characteristics** ( $T_a = 25^\circ\text{C}$ ,  $V_{CC} = 12\text{ V}$ , Unless otherwise specified.)

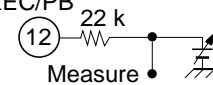
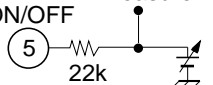
Item	Symbol	Min	Typ	Max	Unit	Test conditions	
Operating voltage	HA12134A	Vo <sub>pe</sub>	6.5	12.0	16.0	V	Enable functional operations
	HA12135A		8.0	12.0	16.0		
	HA12136A		9.5	12.0	16.0		
Quiescent current	I <sub>o</sub>	—	7	—	mA	No signal, REC NR-ON	
Voltage gain of input amp	HA12134A	G <sub>VIA</sub>	21.0	23.0	25.0	dB	Pin 1→Pin 6 (Pin 16→Pin 11) V <sub>out</sub> = 0 dB, f = 1 kHz
	HA12135A		24.5	26.5	28.5		
	HA12136A		26.5	28.5	30.5		
NR encode boost V 8 (9) (NR ON) V 8 (9) (NR OFF)	ENC-1.4 k (1)	2.9	4.4	5.9	dB	f = 1.4 kHz V 8 (9) (NR OFF) = -20 dB	
	ENC-1.4 k (2)	6.0	7.5	9.0	dB	f = 1.4 kHz V 8 (9) (NR OFF) = -30 dB	
	ENC-5 k (1)	1.7	3.2	4.7	dB	f = 5 kHz V 8 (9) (NR OFF) = -20 dB	
	ENC-5 k (2)	6.7	8.2	9.7	dB	f = 5 kHz V 8 (9) (NR OFF) = -30 dB	
	ENC-10 k (1)	-1.1	0.4	1.9	dB	f = 10 kHz V 8 (9) (NR OFF) = 0 dB	
	ENC-10 k (2)	9.8	10.4	11.8	dB	f = 10 kHz V 8 (9) (NR OFF) = -40 dB	
T.H.D (REC)	T.H.D (REC)	—	0.05	0.3	%	f = 1 kHz V 8 (9) (NR ON) = 0 dB	
Signal handling	HA12134A	V <sub>omax</sub>	12.0	13.0	—	dB	f = 1 kHz, $V_{CC} = 6.5\text{ V}$
	HA12135A	(REC)					T.H.D = 1% $V_{CC} = 8.0\text{ V}$
	HA12136A						$V_{CC} = 9.5\text{ V}$
Signal/noise ratio (REC)	S/N (REC)	62.0	68.0	—	dB	R <sub>g</sub> = 5.1 kΩ weighted CCIR/ARM	
Crosstalk (ENC) (Pin 8 – Pin 9)	CT R→L L→R	52.0	60.0	—	dB	f = 1 kHz NR OFF	
Control voltage for REC/PB	REC	2.5	—	V <sub>CC</sub>	V	REC/PB 	
	PB	0.0	—	0.5			
Control voltage for NR ON/OFF	ON	2.5	—	V <sub>CC</sub>	V	NR ON/OFF 	
	OFF	0.0	—	0.5			
Channel balance	ΔG <sub>VIA</sub>	-1.0	0.0	1.0	dB		

## HA12134A, HA12135A, HA12136A

**Electrical Characteristics** ( $T_a = 25^\circ\text{C}$ ,  $V_{cc} = 12\text{ V}$ , Unless otherwise specified.) (cont)

Item	Symbol	Min	Typ	Max	Unit	Test conditions
Offset voltage V 8 (9) (NR-ON) – V 8 (9) (NR-OFF)	$\Delta V_{\text{orec}}$	-50	0.0	50	mV	REC mode $V_{cc} = 16.0\text{ V}$

### Test Circuit

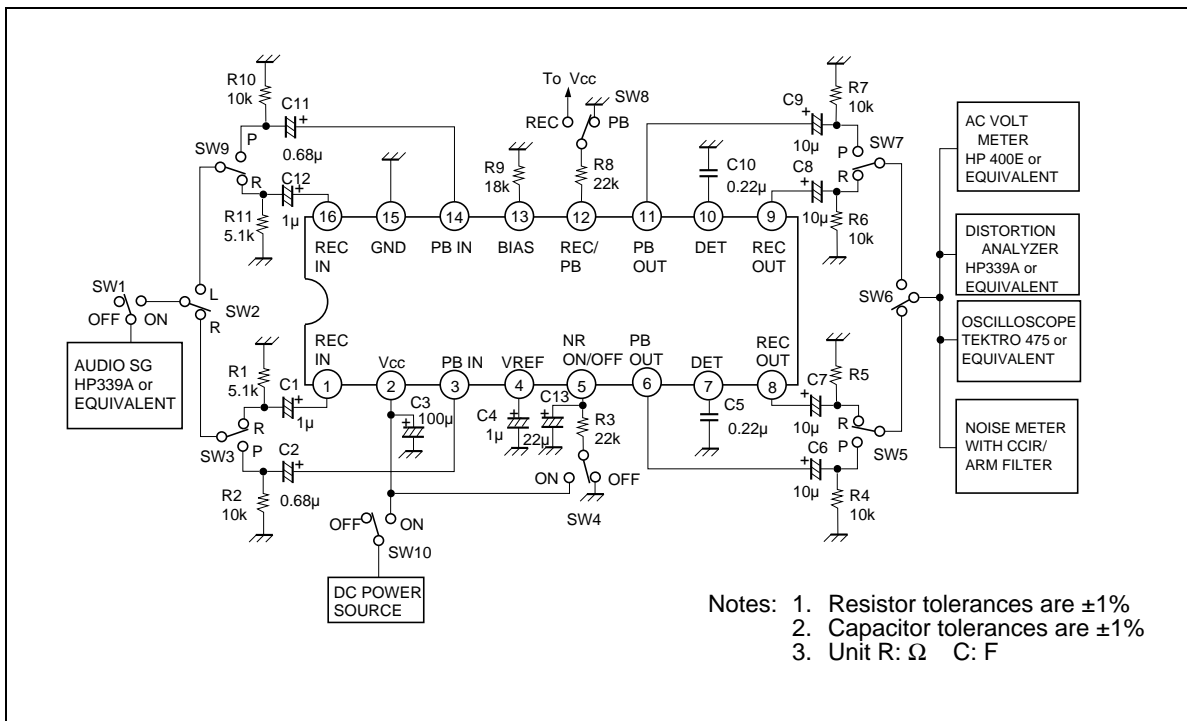

## HA12134A, HA12135A, HA12136A

**Pin Description** ( $T_a = 25^\circ\text{C}$ ,  $V_{CC} = 12\text{ V}$ , No signal, The value in the table show typical value.)

Pin No.	Symbol	R (in)	VDC	Equivalent circuit	Description
1, 16	REC IN	56 k $\Omega$	6.0 V		Recording (encode) input
2	$V_{CC}$	—	12.0 V		Power supply
3, 14	PB IN	100 k $\Omega$	6.0 V		Playback (decode) input
4	$V_{REF}$	—	6.0 V		Reference voltage
5	NR ON/OFF	—	—		Mode control pin for NR ON/OFF "H" → NR ON "L" → NR OFF
6, 11	PB OUT	—	6.0 V		Playback (decode) output

## HA12134A, HA12135A, HA12136A

**Pin Description** ( $T_a = 25^\circ\text{C}$ ,  $V_{CC} = 12\text{ V}$ , No signal, The value in the table show typical value.) (cont)

Pin No.	Symbol	R (in)	VDC	Equivalent circuit	Description
7, 10	DET	—	1.3 V		Time constant pin for the level detector
8, 9	REC OUT	—	6.0 V		Recording (encode) output
12	REC/PB	—	—		Mode control pin for REC/PB (encode/decode) "H" → REC (encode) "L" → PB (decode)
13	BIAS	—	1.0 V		Reference current input pin for the active filters
15	GND	—	0 V	—	Ground

## HA12134A, HA12135A, HA12136A

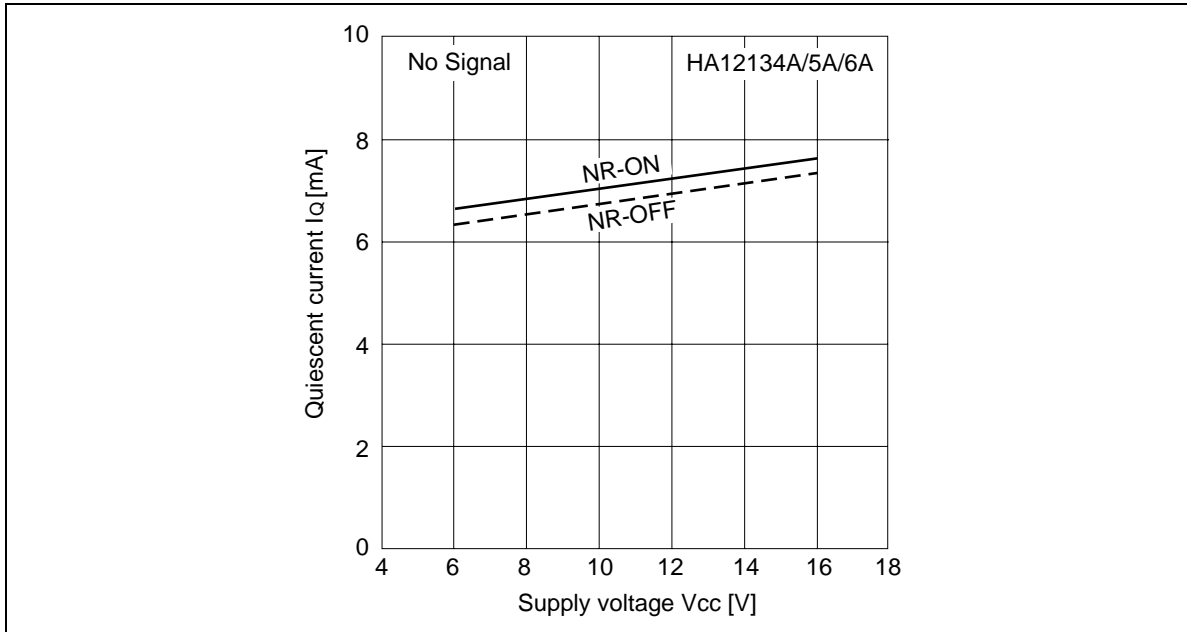

Figure 1 Quiescent Current vs. Supply Voltage

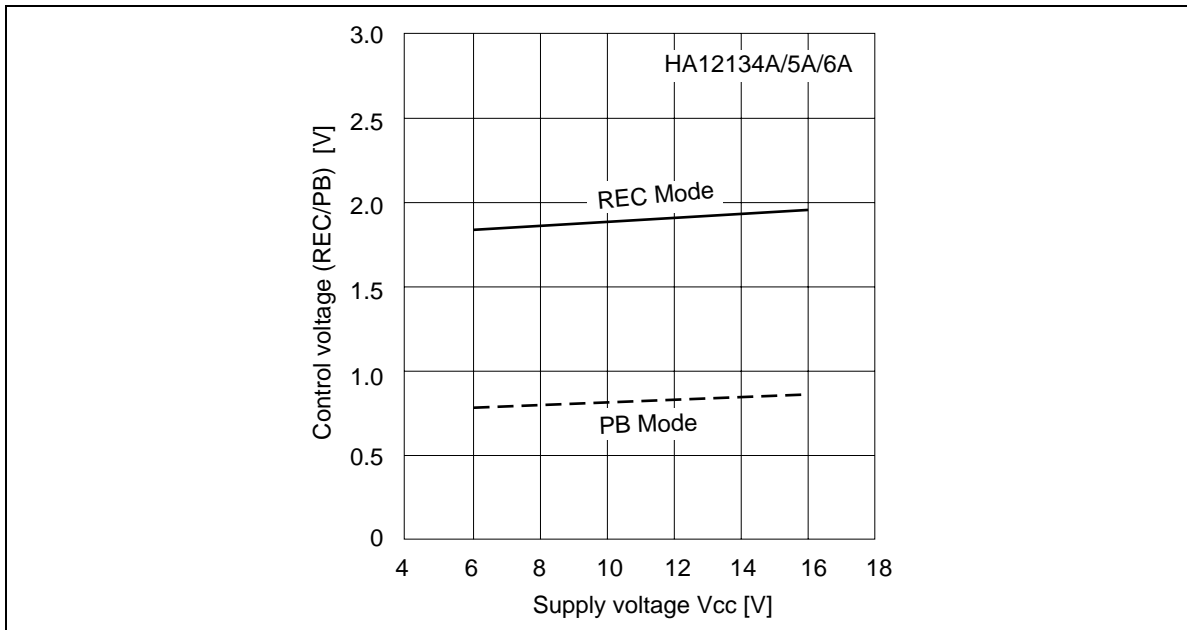

Figure 2 REC/PB Control Voltage vs. Supply Voltage



## HA12134A, HA12135A, HA12136A

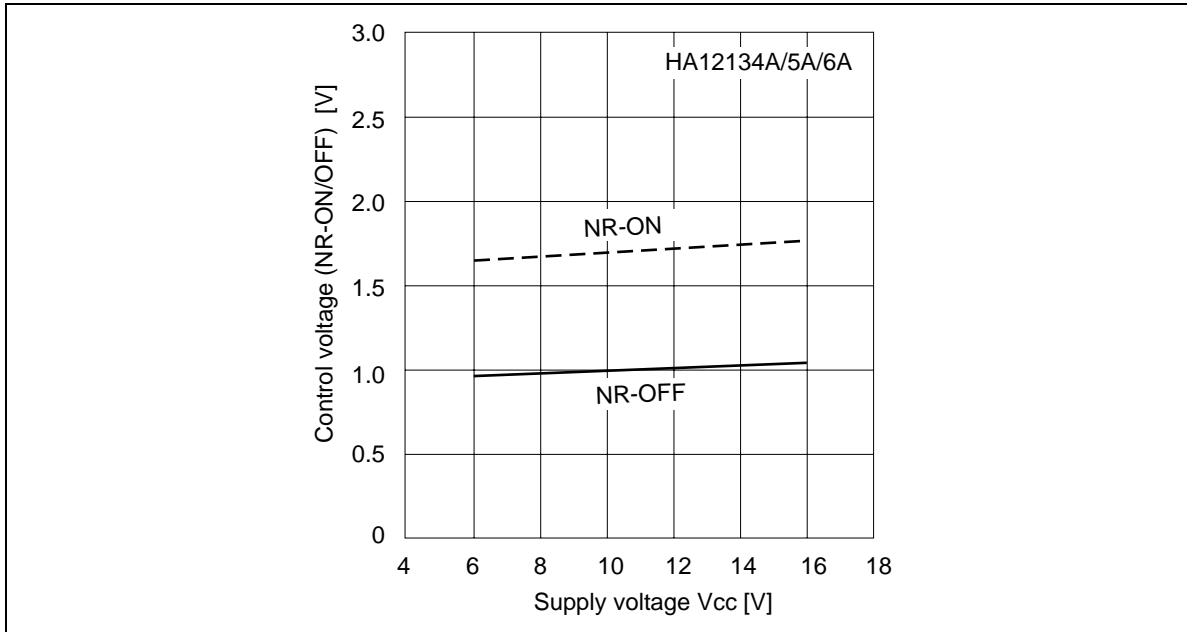

Figure 3 NR-ON/OFF Control Voltage vs. Supply Voltage

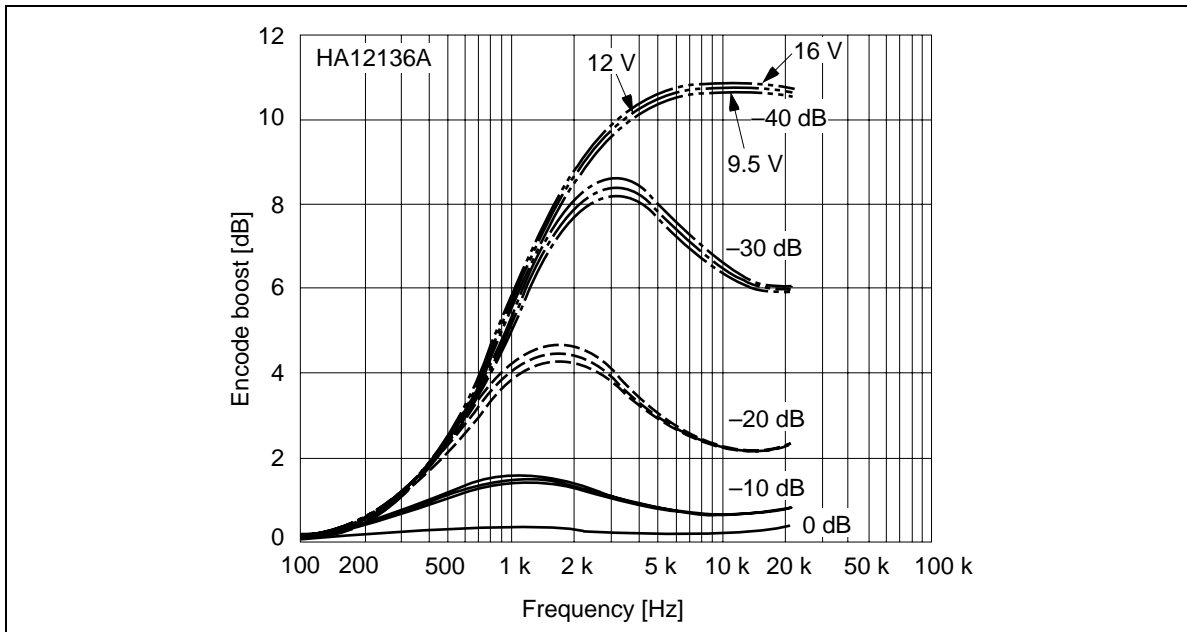

Figure 4 Encode Boost vs. Frequency

## HA12134A, HA12135A, HA12136A

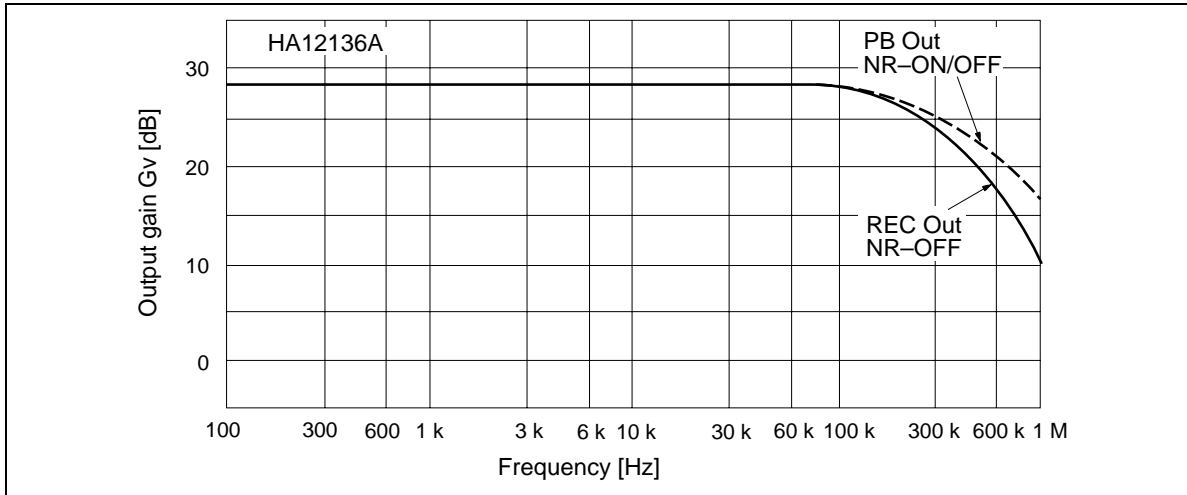

Figure 5 REC Mode Output Gain vs. Frequency

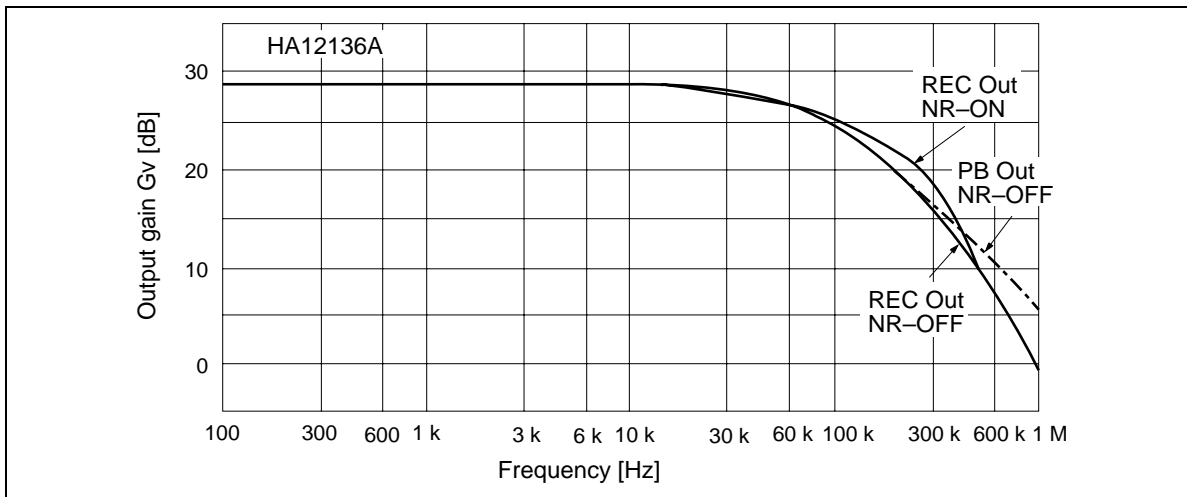

Figure 6 PB Mode Output Gain vs. Frequency

## HA12134A, HA12135A, HA12136A

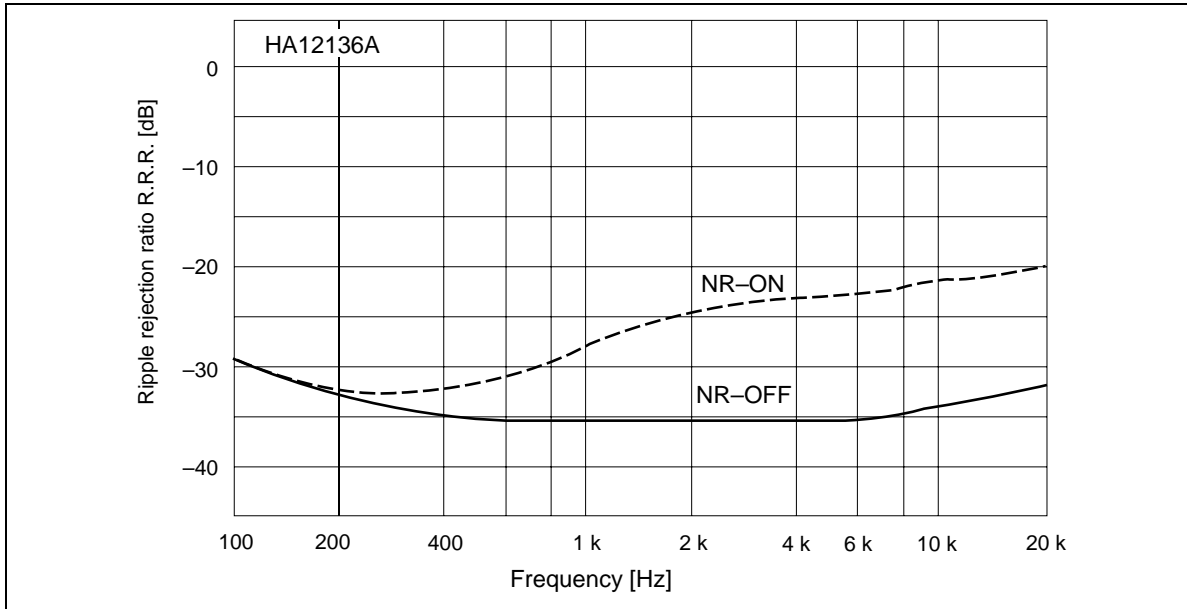

Figure 7 REC Mode Ripple Rejection Ratio vs. Frequency

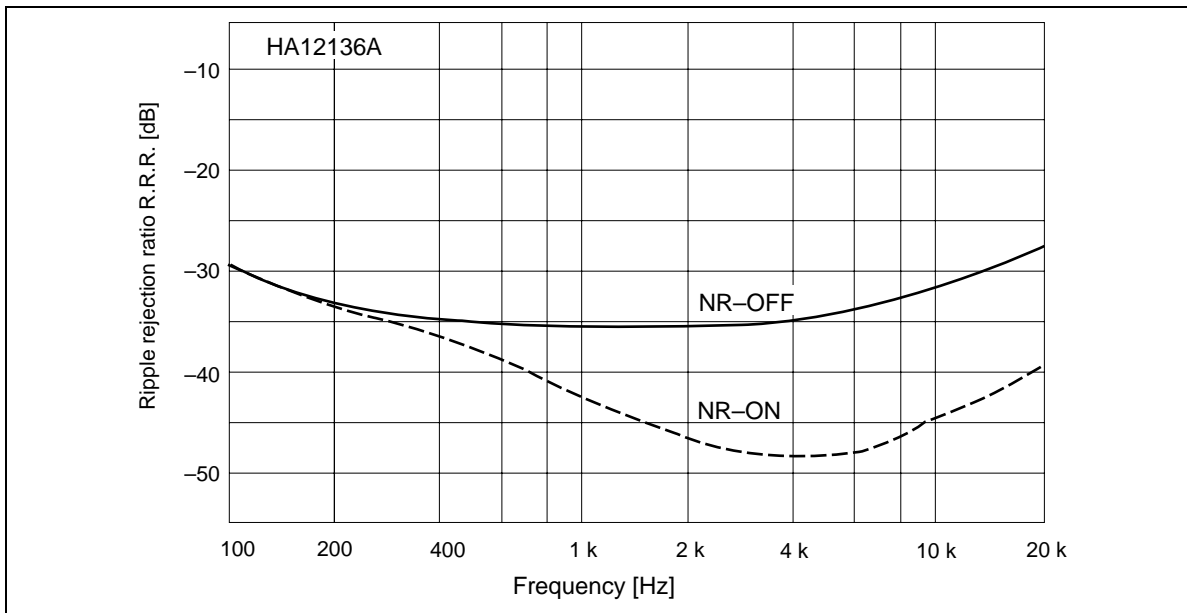

Figure 8 PB Mode Ripple Rejection Ratio vs. Frequency

# HA12134A, HA12135A, HA12136A

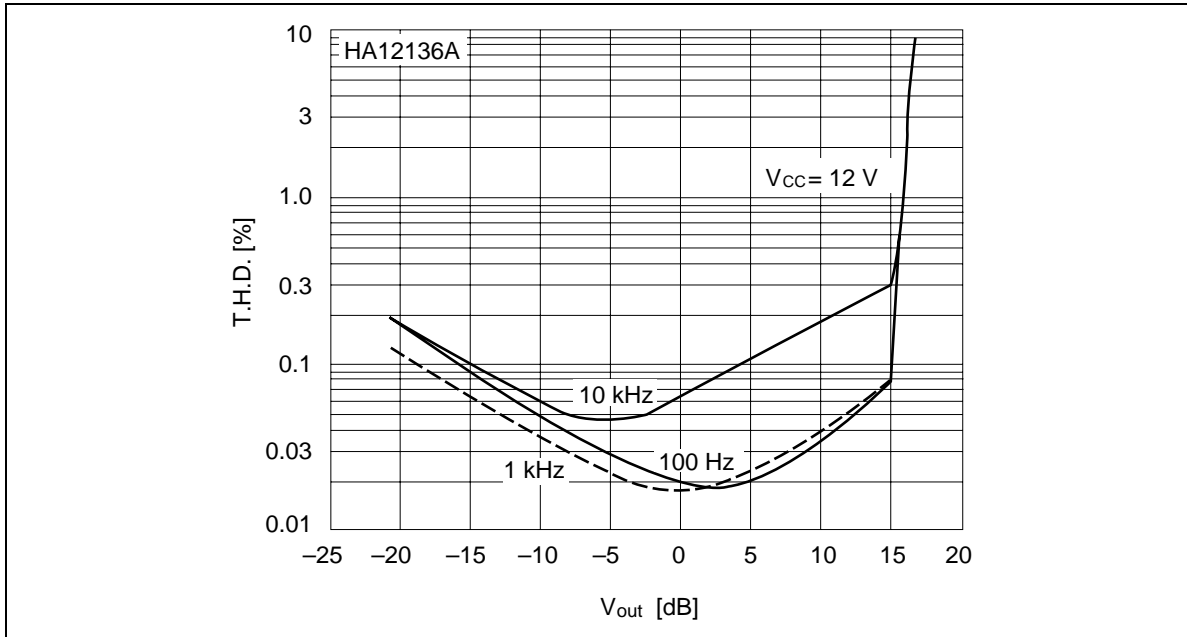

Figure 9 REC NR-OFF Total Harmonic Distortion vs. Output Level

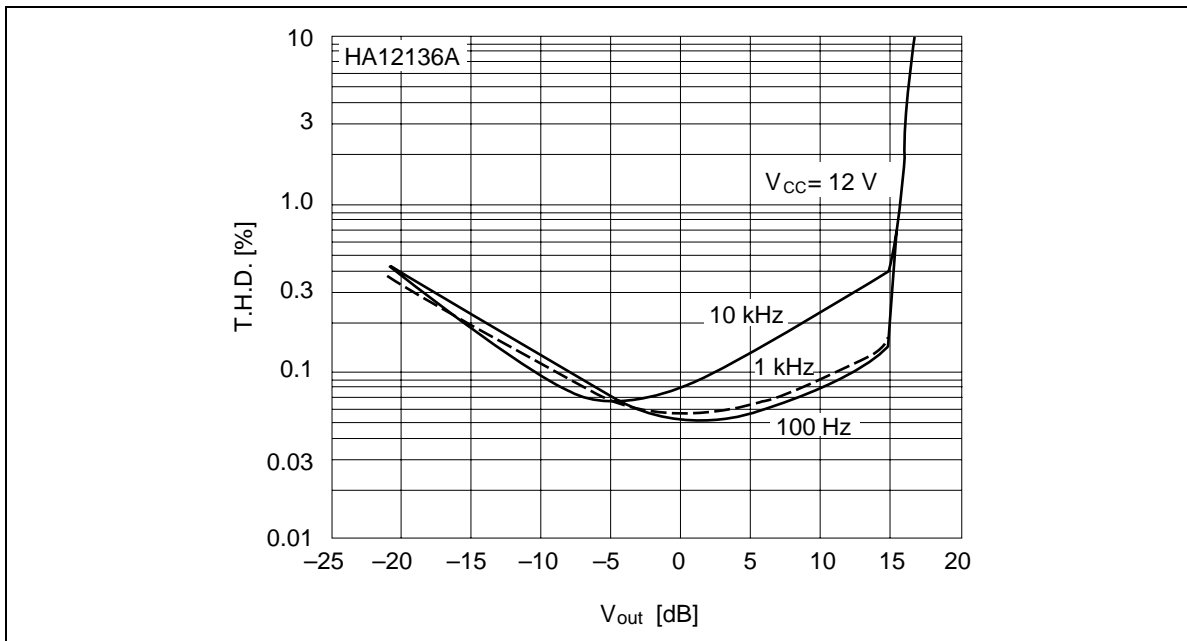

Figure 10 REC NR-ON Total Harmonic Distortion vs. Output Level

HA12134A, HA12135A, HA12136A

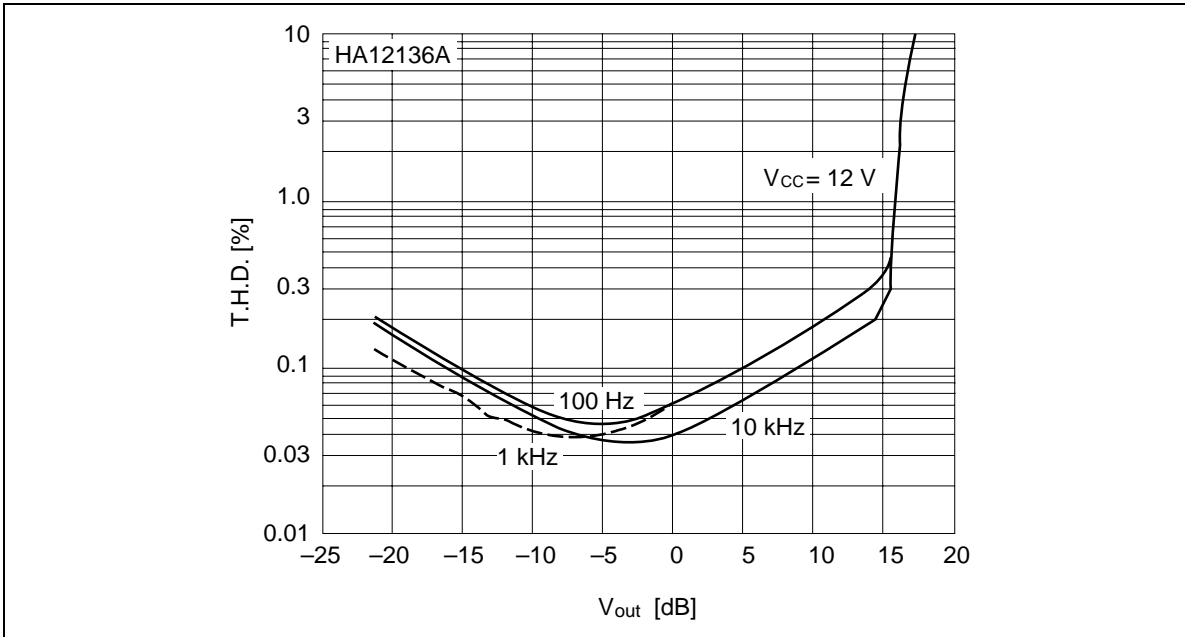

Figure 11 PB NR-OFF Total Harmonic Distortion vs. Output Level

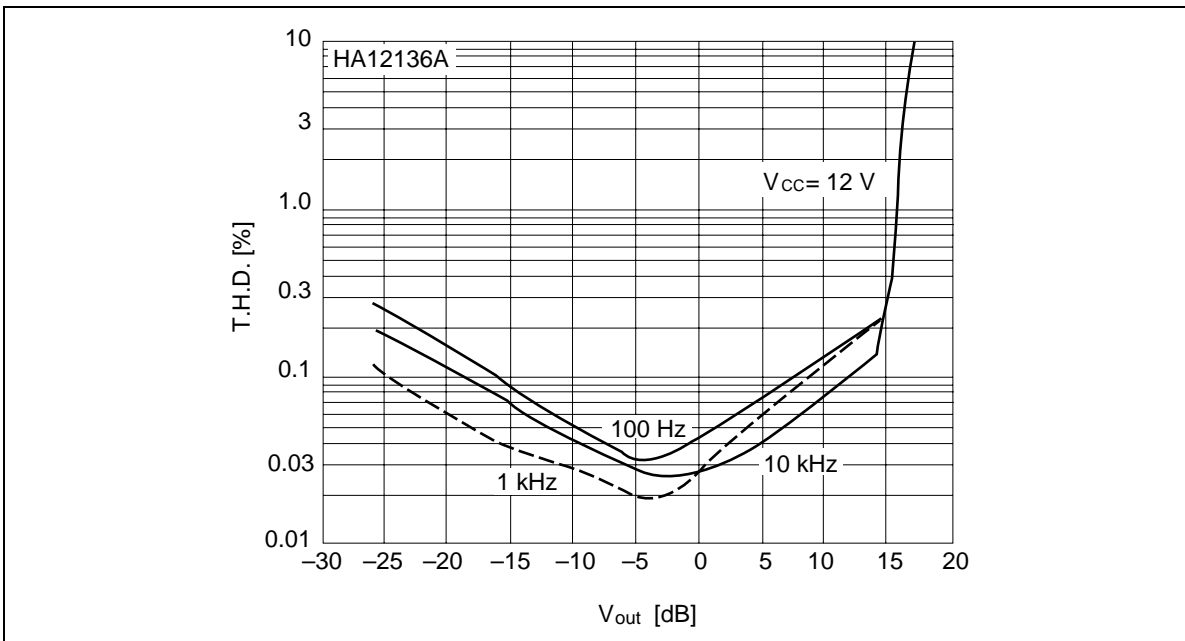

Figure 12 PB NR-ON Total Harmonic Distortion vs. Output Level

# HA12134A, HA12135A, HA12136A

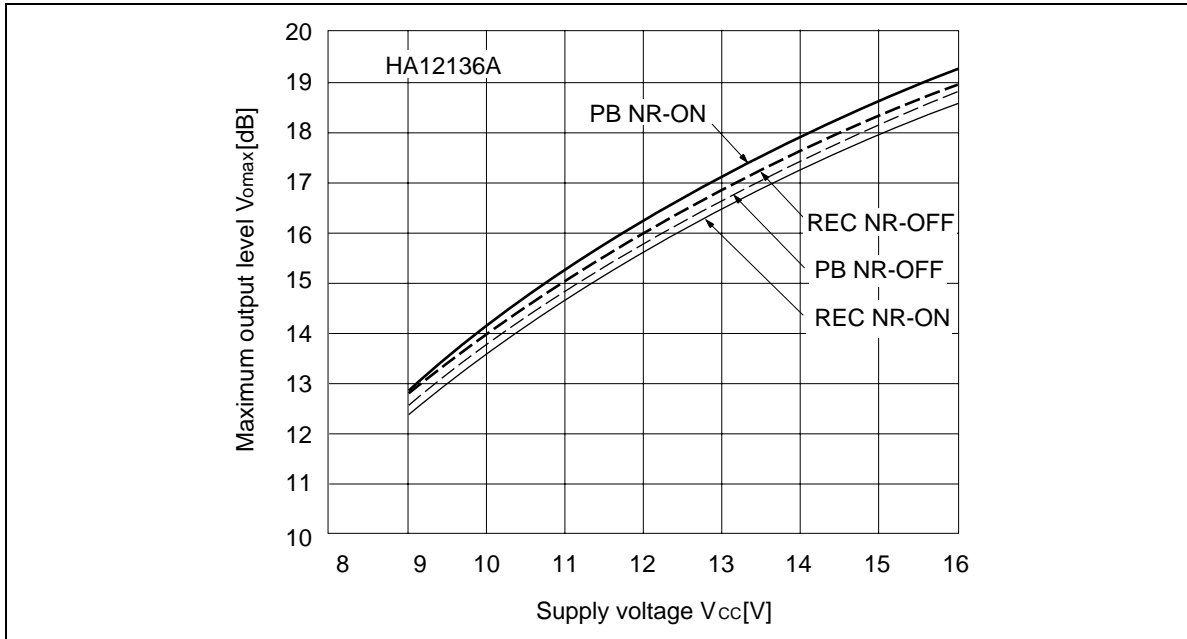

Figure 13 Maximum Output Level vs. Supply Voltage

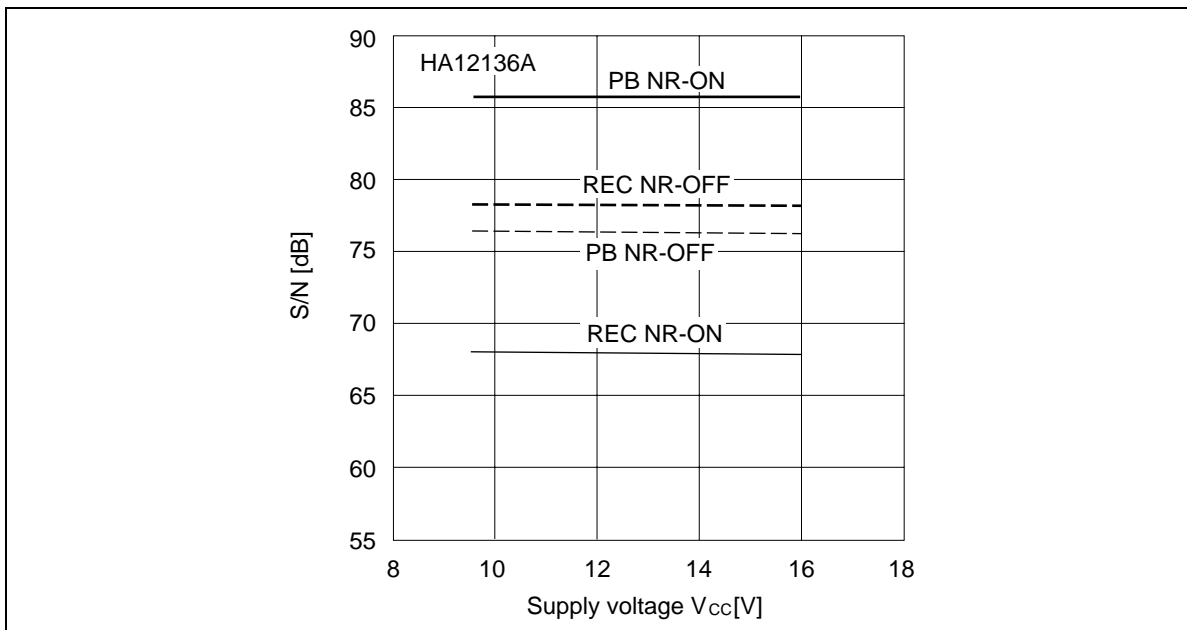
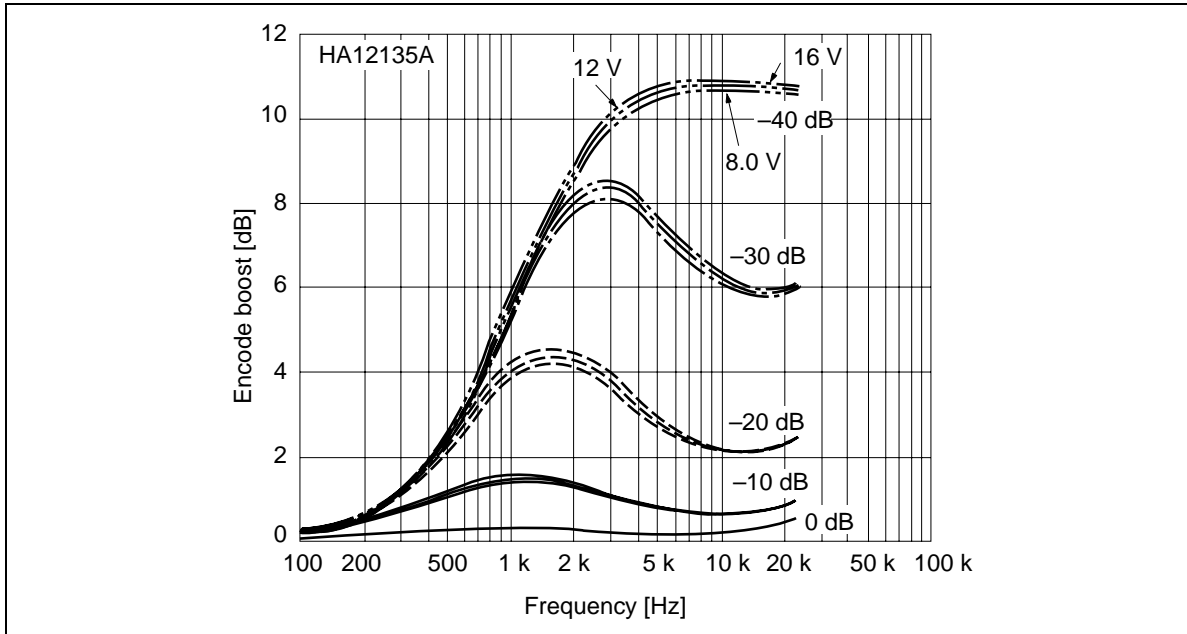
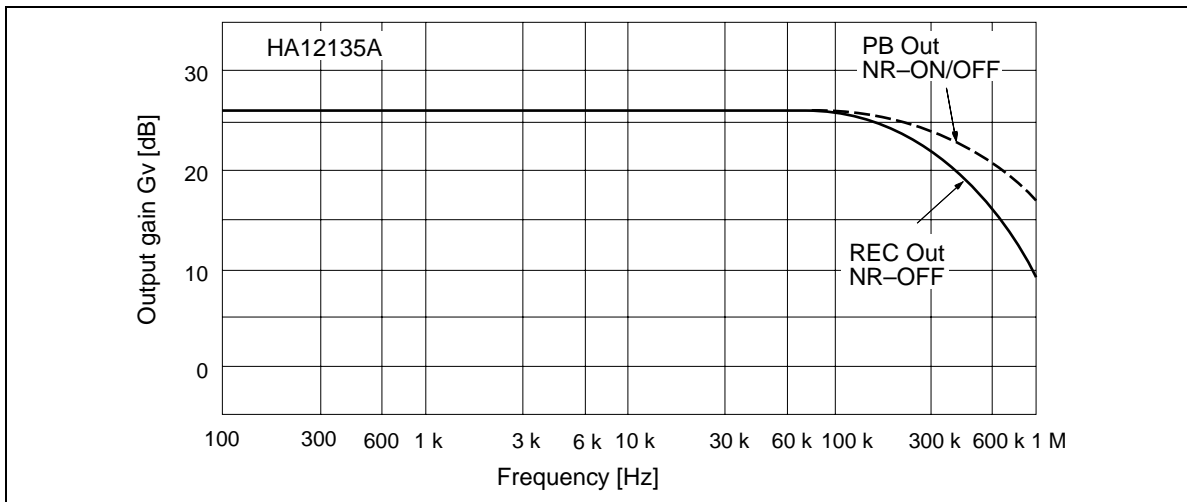

Figure 14 REC/PB Signal To Noise Ratio vs. Supply Voltage

**HA12134A, HA12135A, HA12136A**



**Figure 15 Encode Boost vs. Frequency**



**Figure 16 REC Mode Output Gain vs. Frequency**

## HA12134A, HA12135A, HA12136A

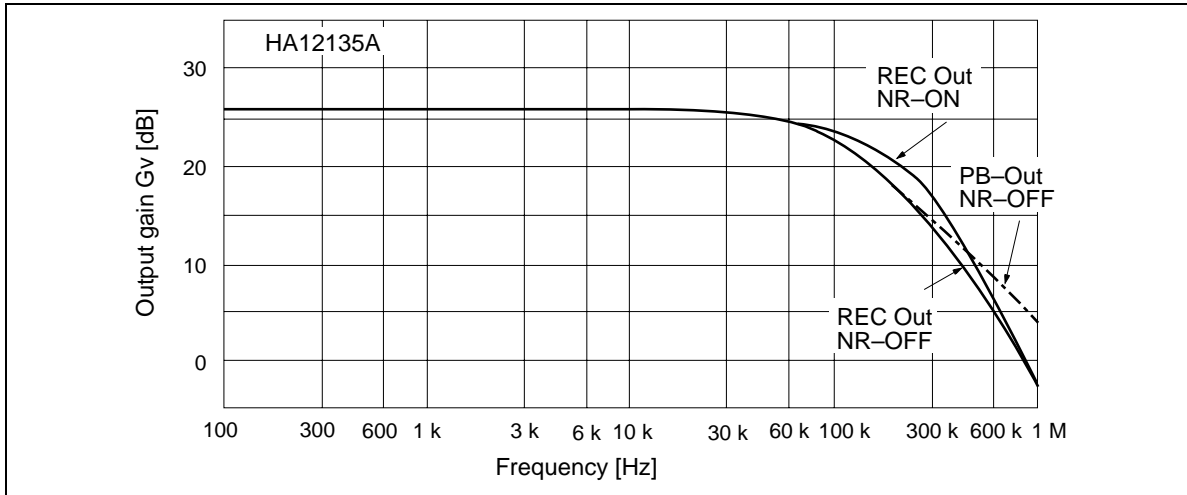

Figure 17 PB Mode Output Gain vs. Frequency

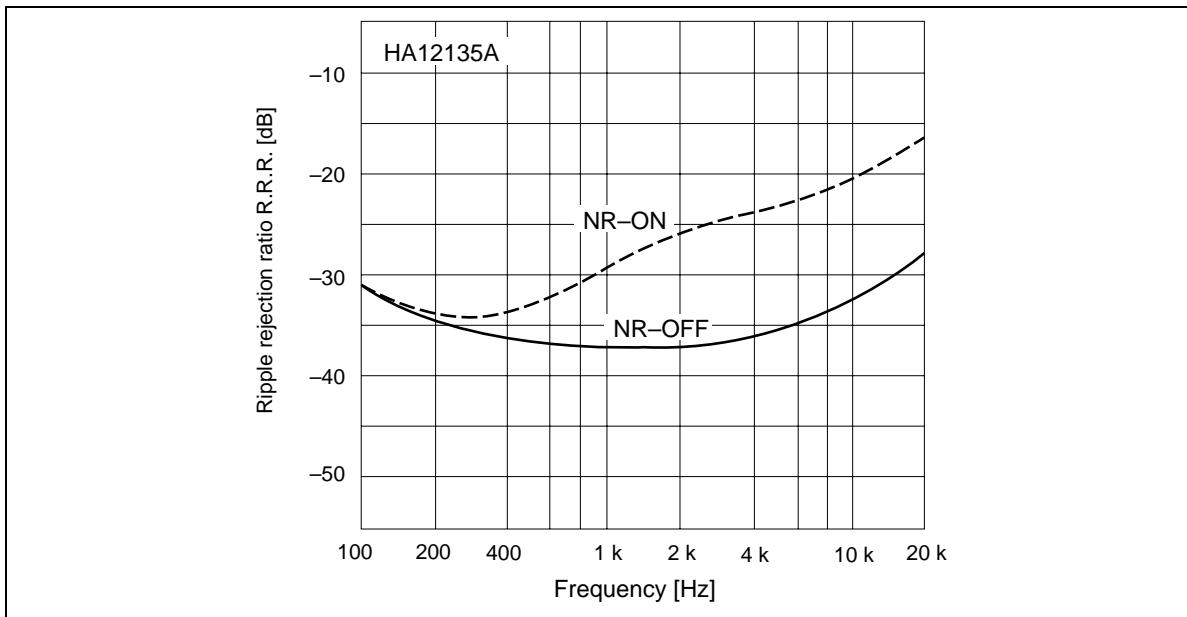

Figure 18 REC Mode Ripple Rejection Ratio vs. Frequency



## HA12134A, HA12135A, HA12136A

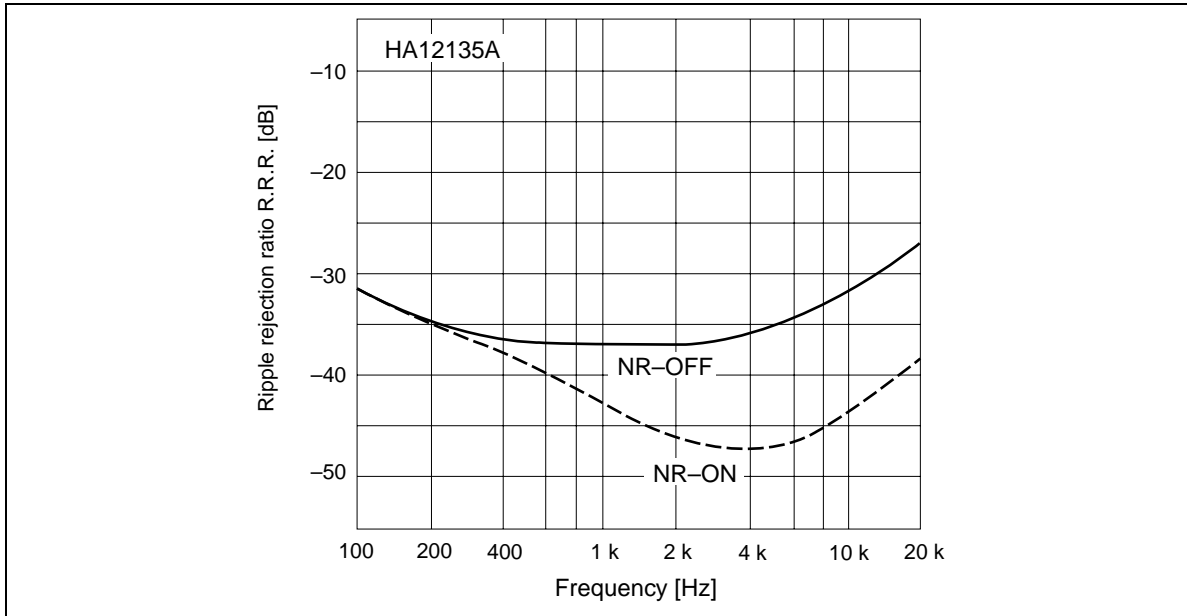

Figure 19 PB Mode Ripple Rejection Ratio vs. Frequency

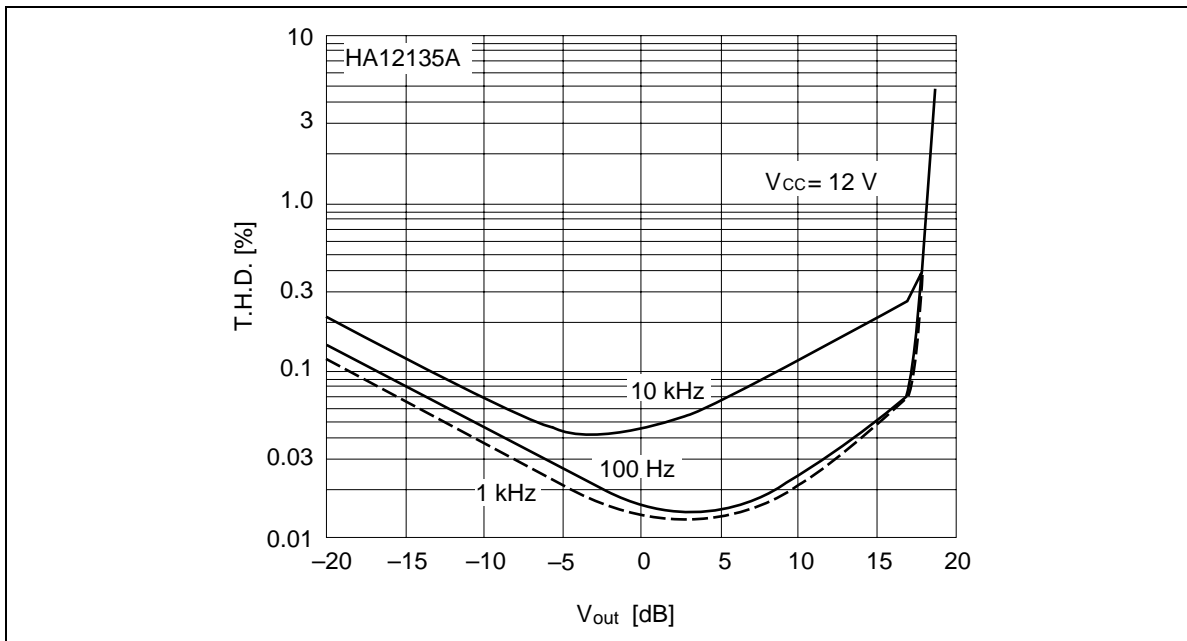

Figure 20 REC NR-OFF Total Harmonic Distortion vs. Output Level

# HA12134A, HA12135A, HA12136A

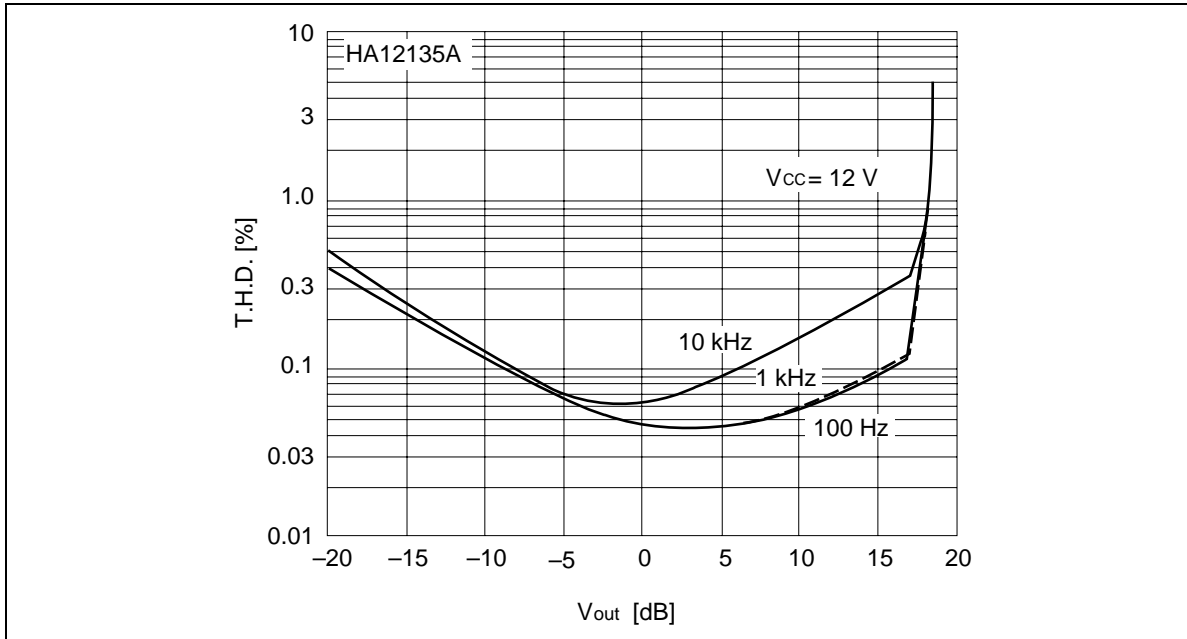

Figure 21 REC NR-ON total Harmonic Distortion vs. Output Level

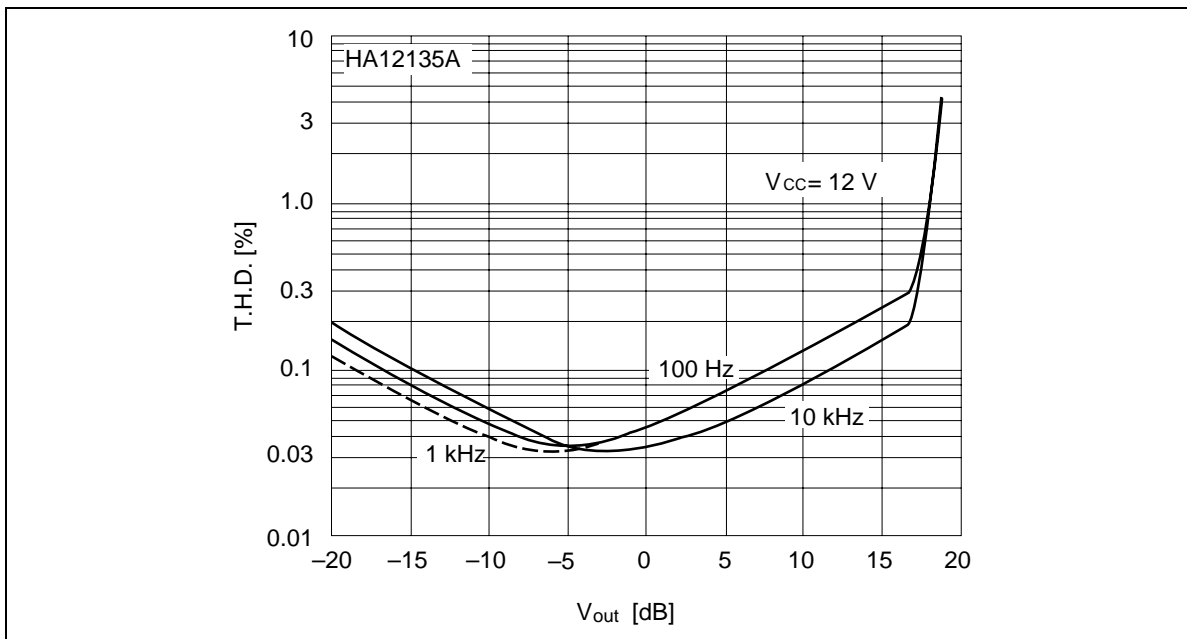

Figure 22 PB NR-OFF Total Harmonic Distortion vs. Output Level

HA12134A, HA12135A, HA12136A

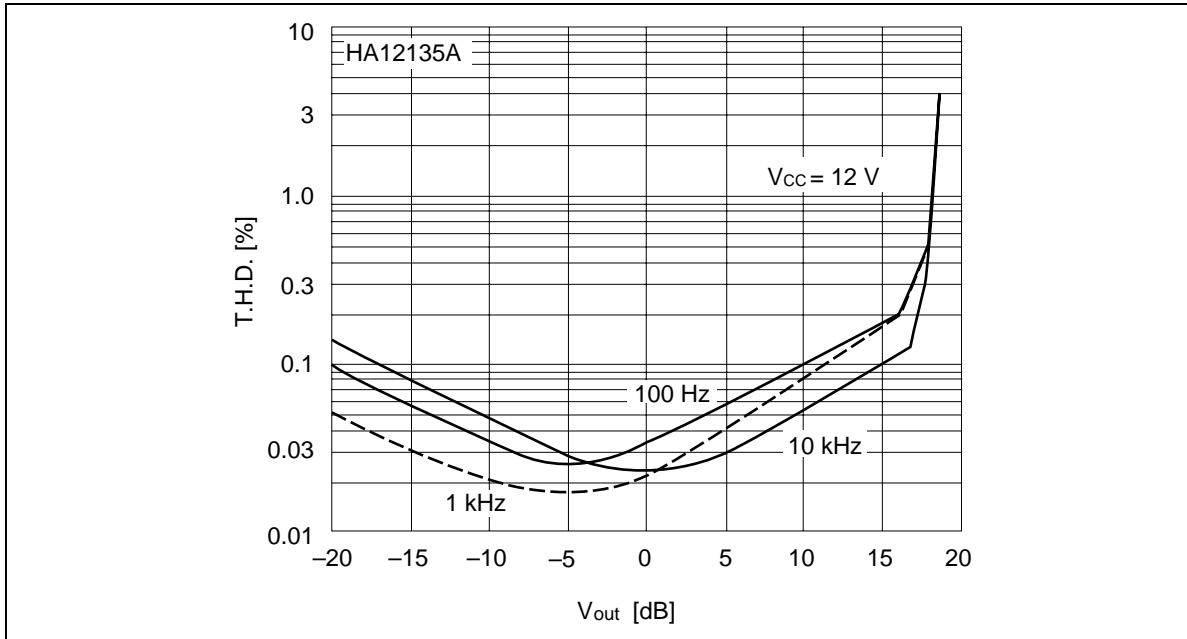

Figure 23 PB NR-ON Total Harmonic Distortion vs. Output Level

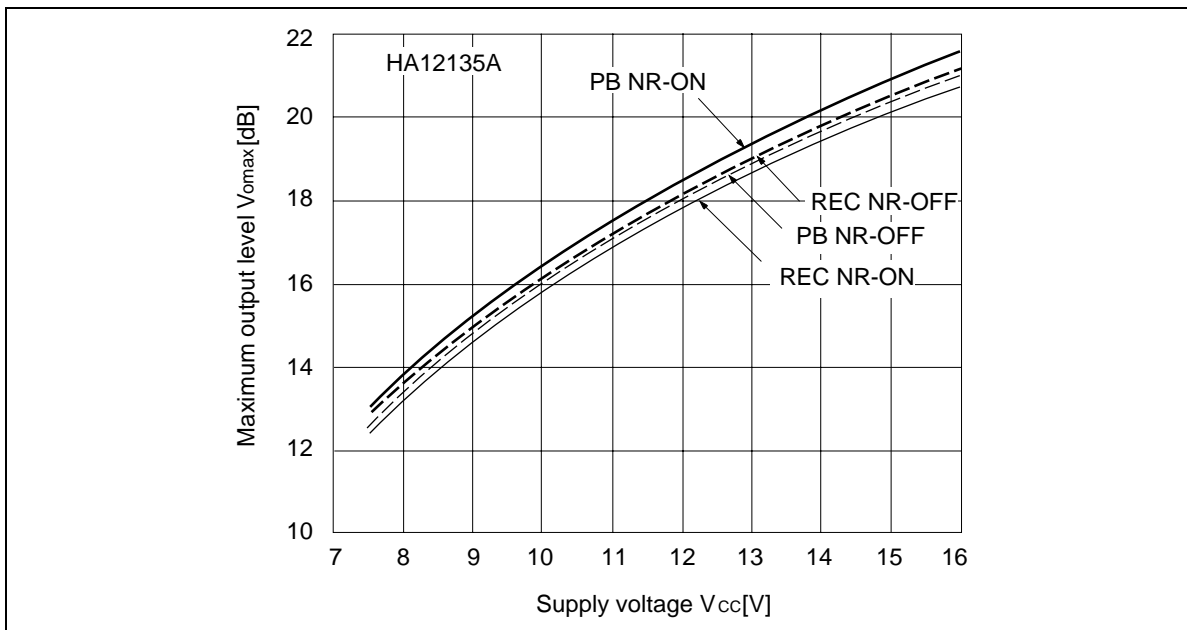

Figure 24 Maximum Output Level vs. Supply Voltage

# HA12134A, HA12135A, HA12136A

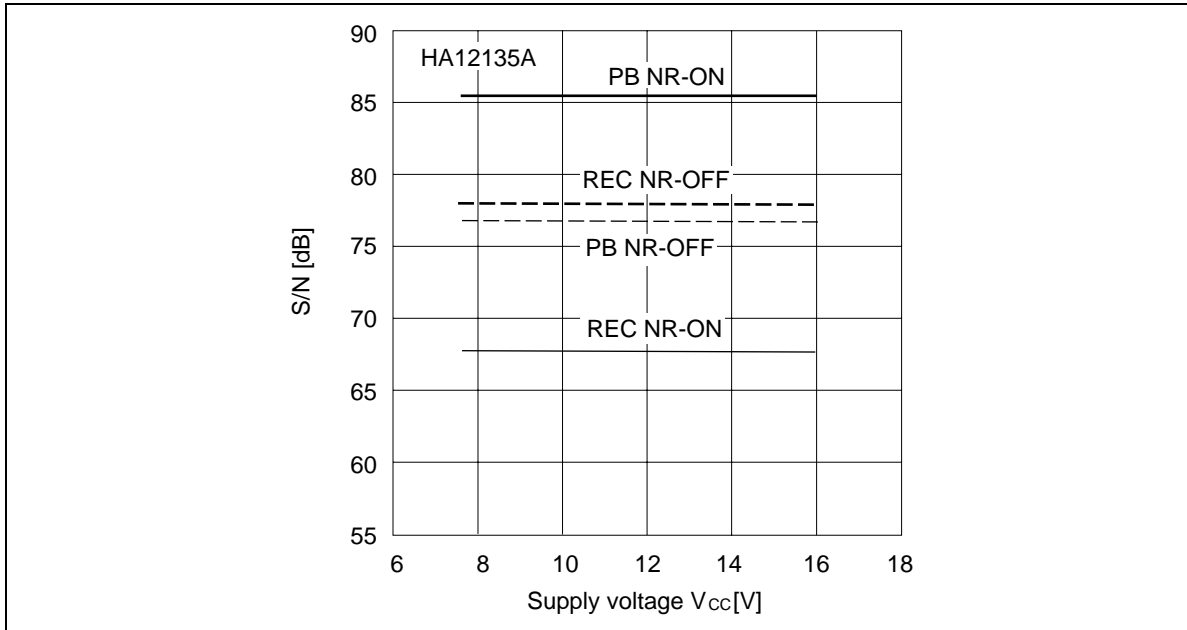

Figure 25 REC/PB Signal to Noise Ratio vs. Supply Voltage

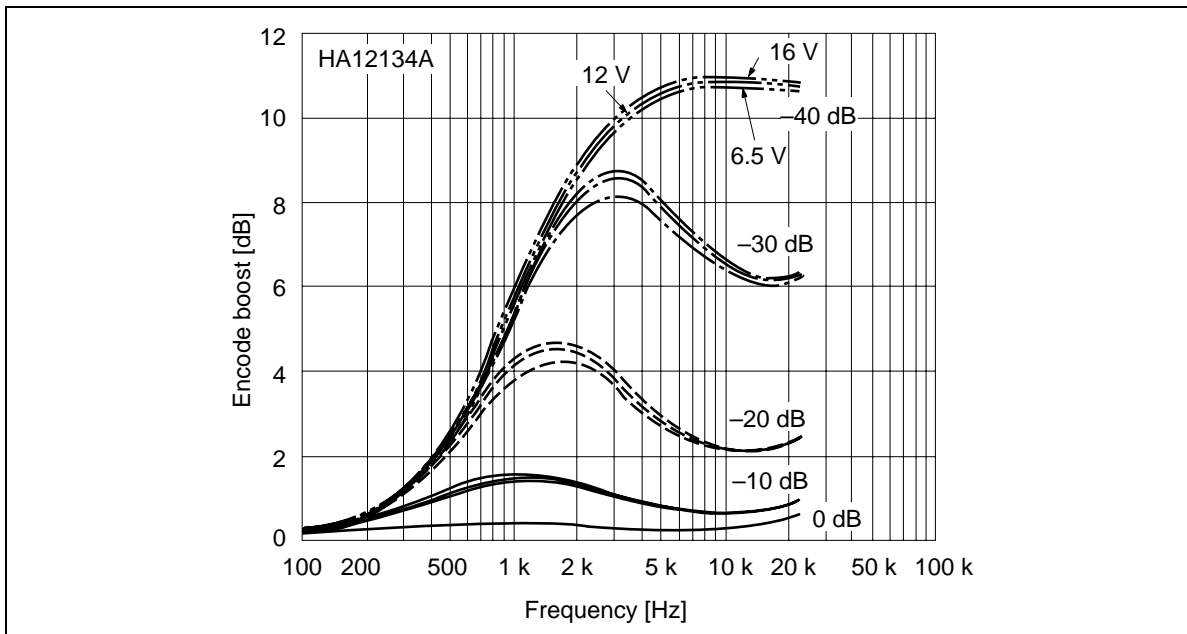

Figure 26 Encode Boost vs. Frequency

## HA12134A, HA12135A, HA12136A

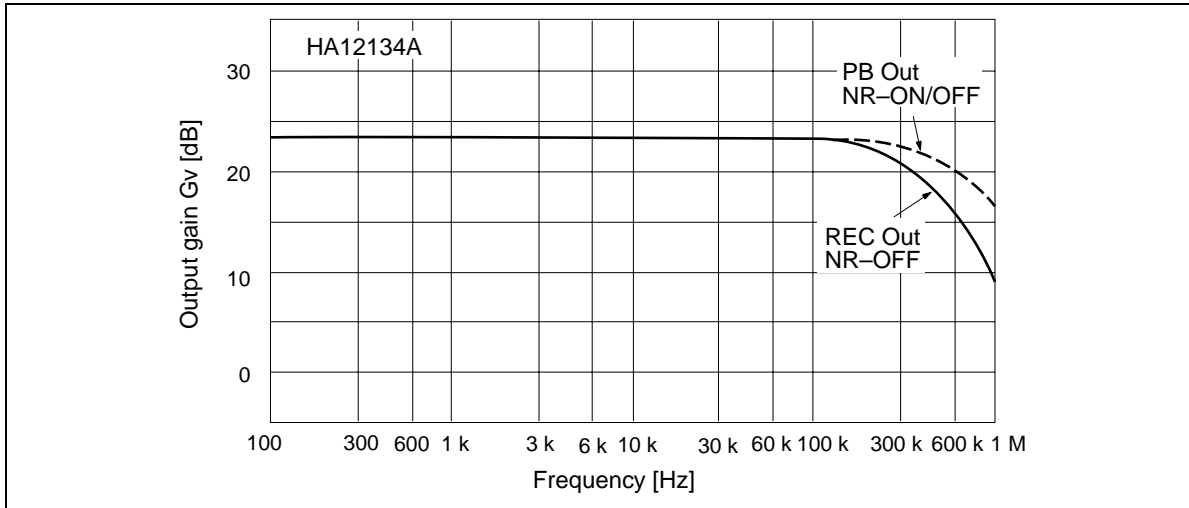

Figure 27 REC Mode Output Gain vs. Frequency

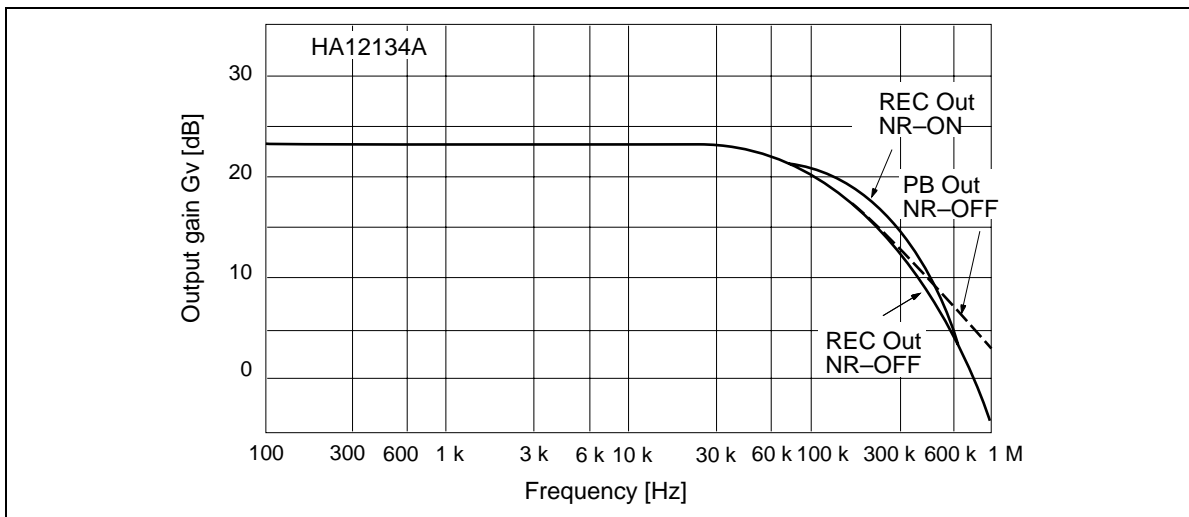

Figure 28 PB Mode Output Gain vs. Frequency

## HA12134A, HA12135A, HA12136A

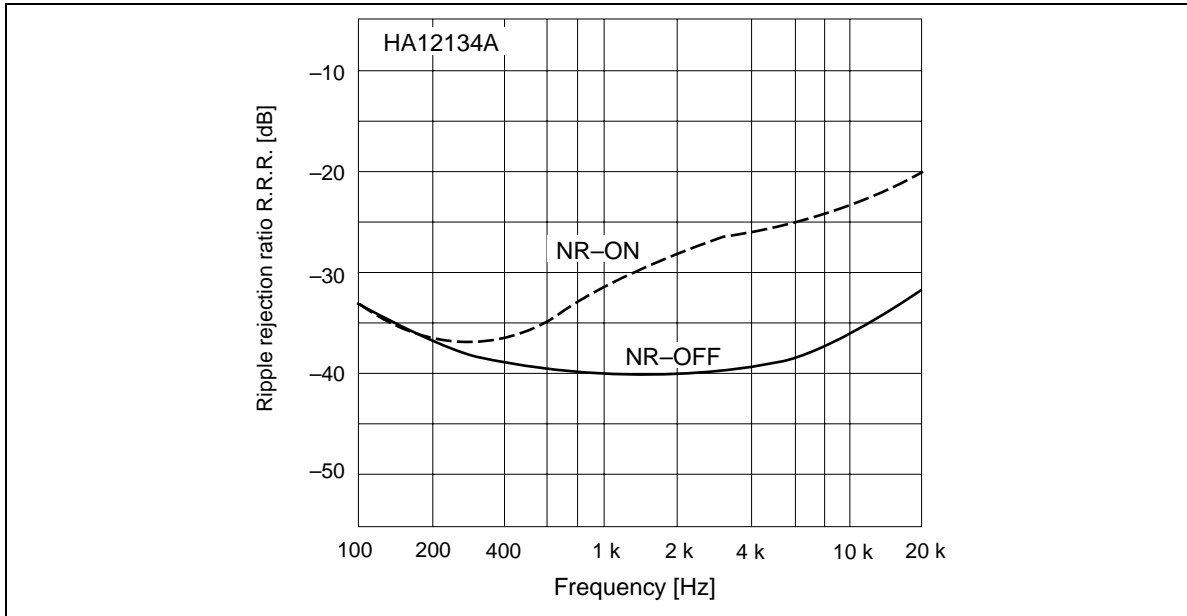

Figure 29 REC Mode Ripple Rejection Ratio vs. Frequency

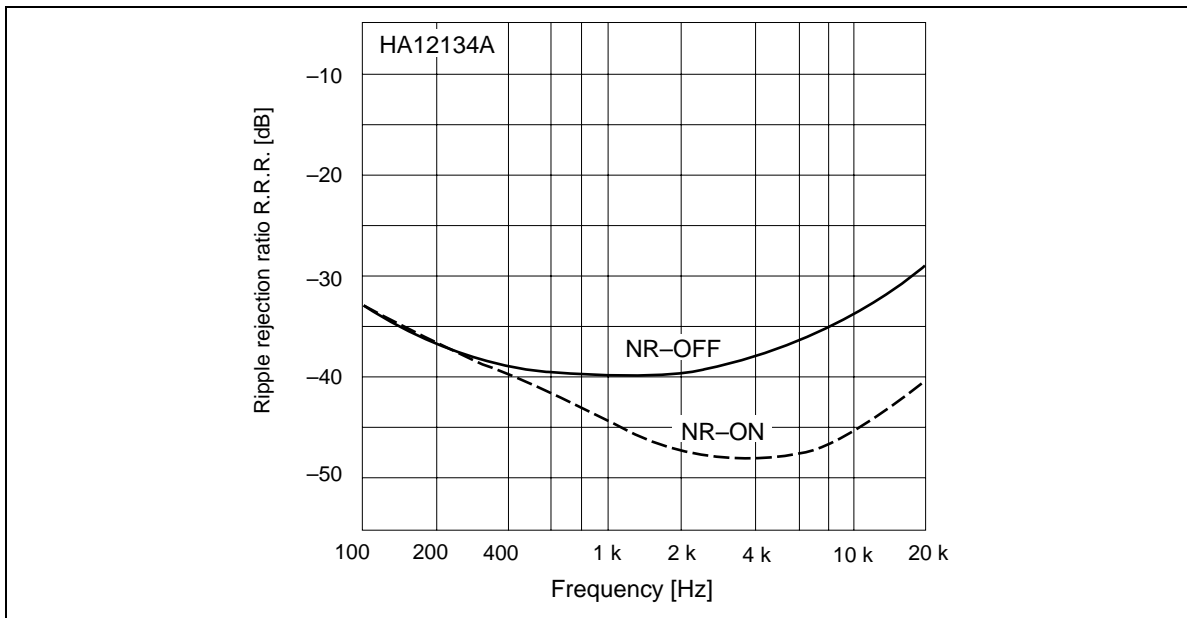

Figure 30 PB Mode Ripple Rejection Ratio vs. Frequency

## HA12134A, HA12135A, HA12136A

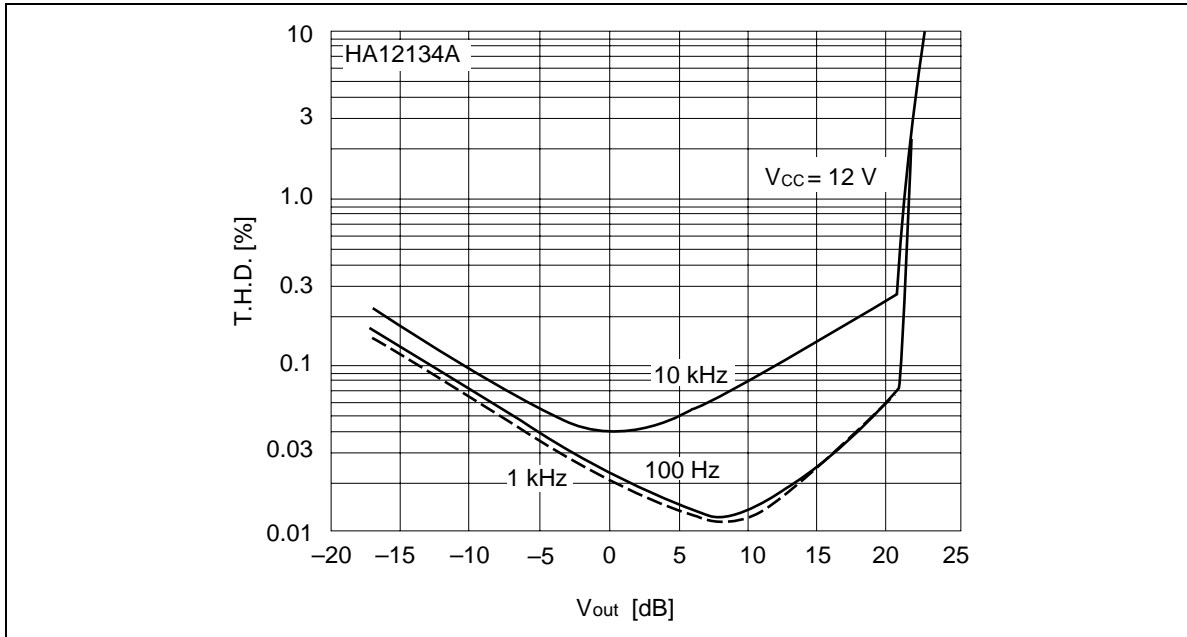

Figure 31 REC NR-OFF Total Harmonic Distortion vs. Output Level

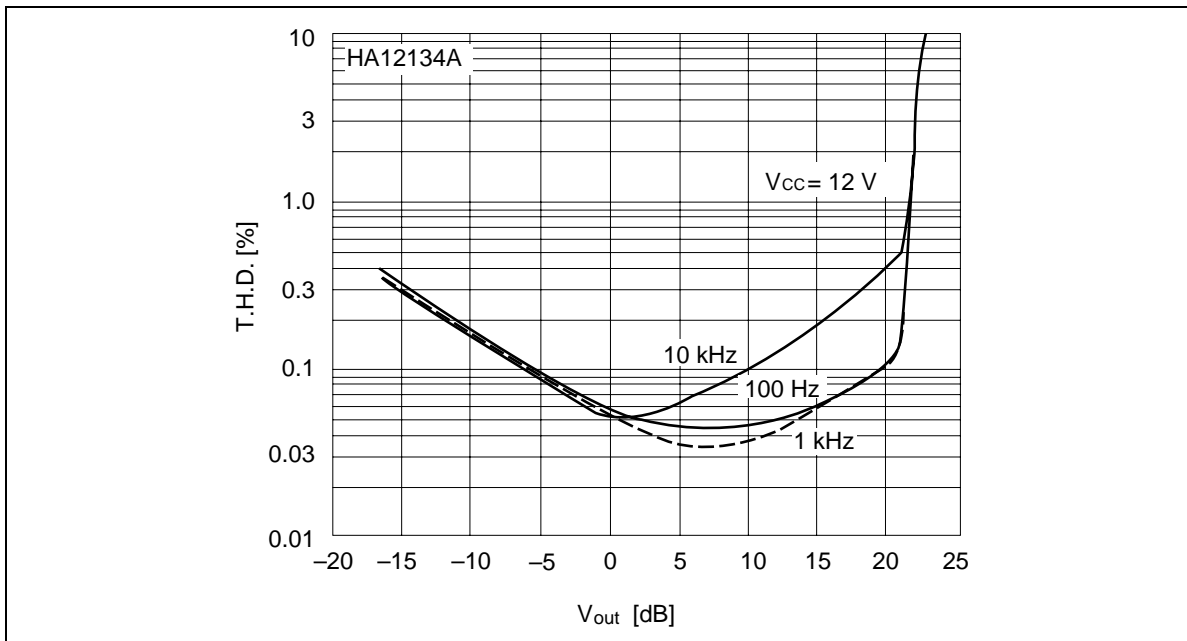

Figure 32 REC NR-ON Total Harmonic Distortion vs. Output Level

# HA12134A, HA12135A, HA12136A

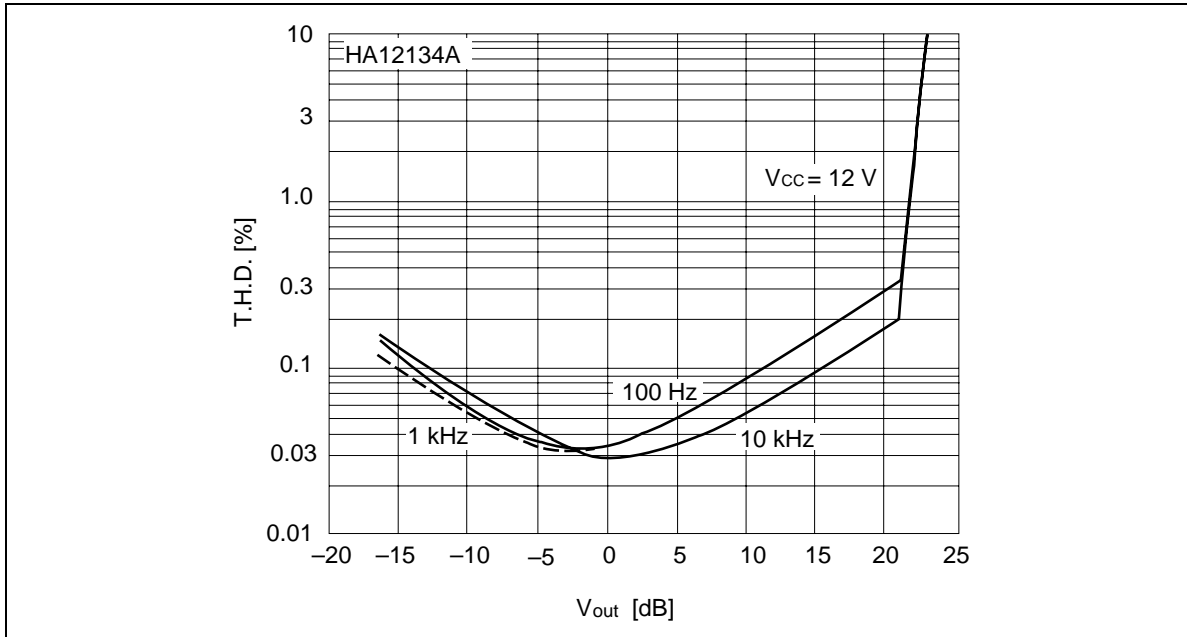

Figure 33 PB NR-OFF Total Harmonic Distortion vs. Output Level

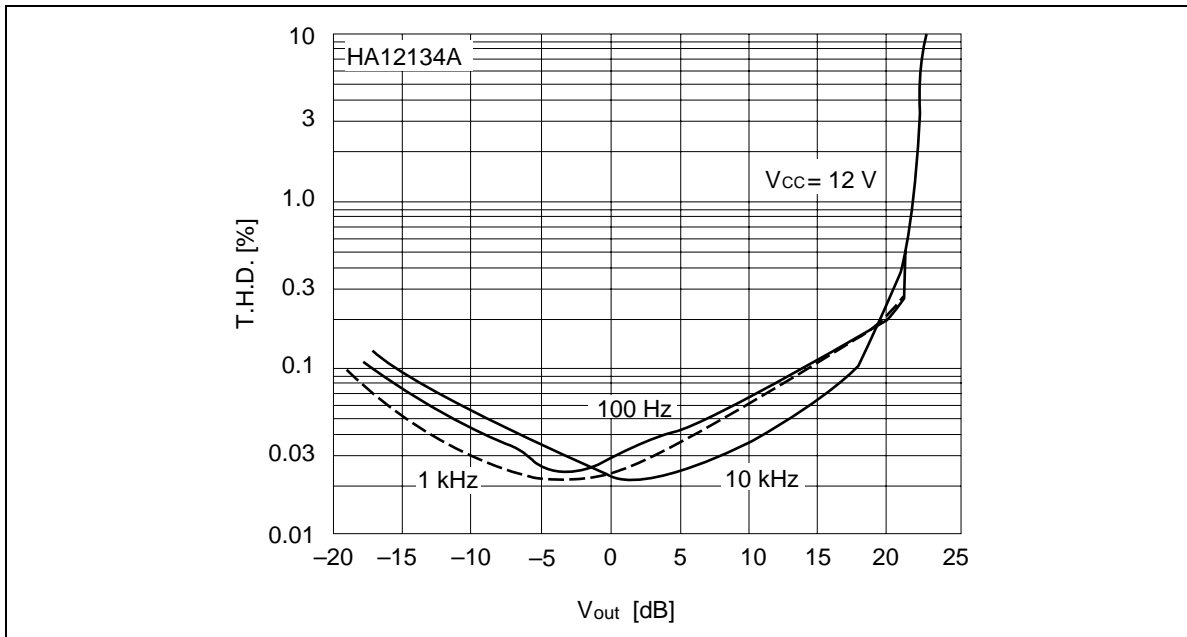
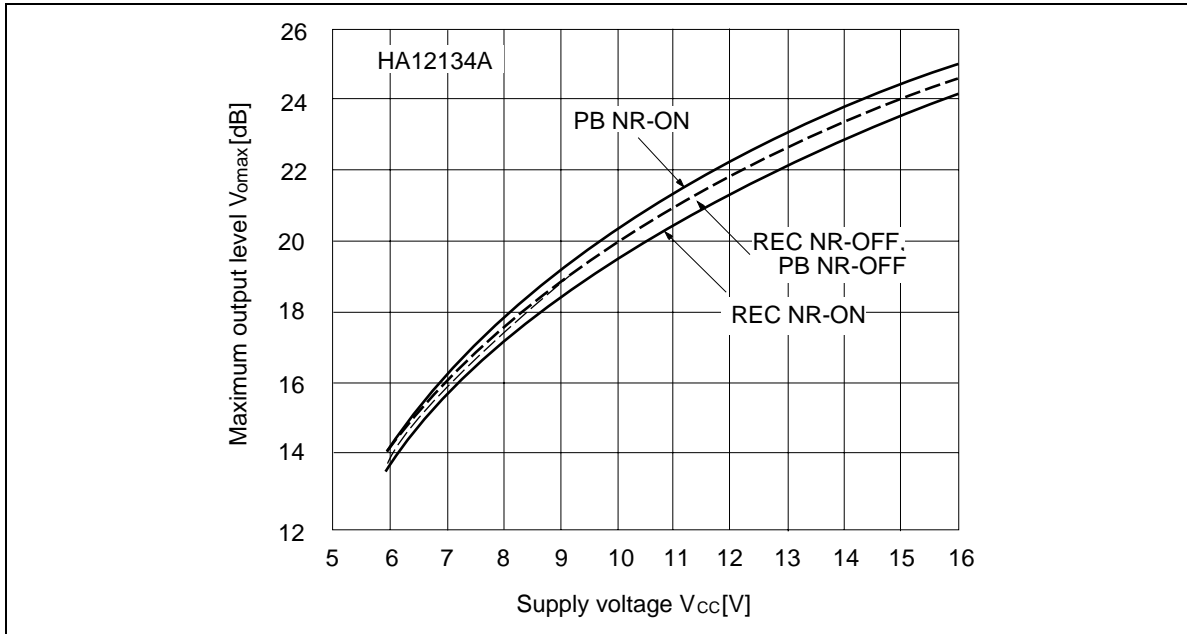

Figure 34 PB NR-ON Total Harmonic Distortion vs. Output Level



**HA12134A, HA12135A, HA12136A**



**Figure 35 Maximum Output Level vs. Supply Voltage**

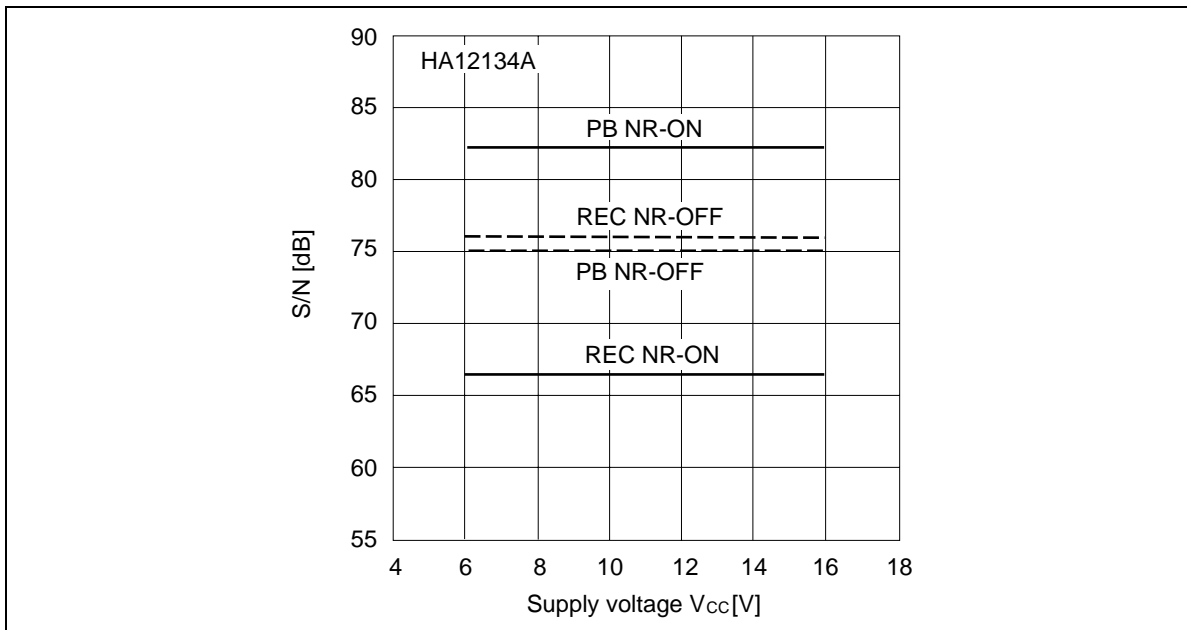

**Figure 36 REC/PB Signal To Noise Ratio vs. Supply Voltage**

# HA12134A, HA12135A, HA12136A

## Package Dimesnsions

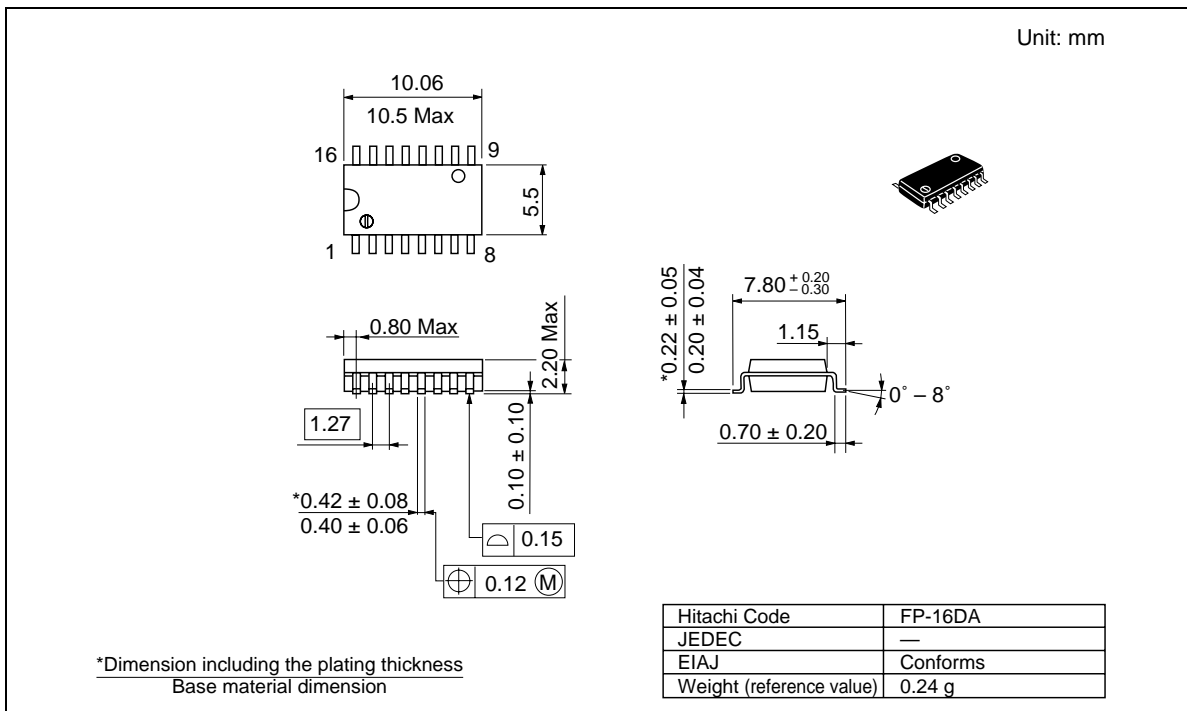
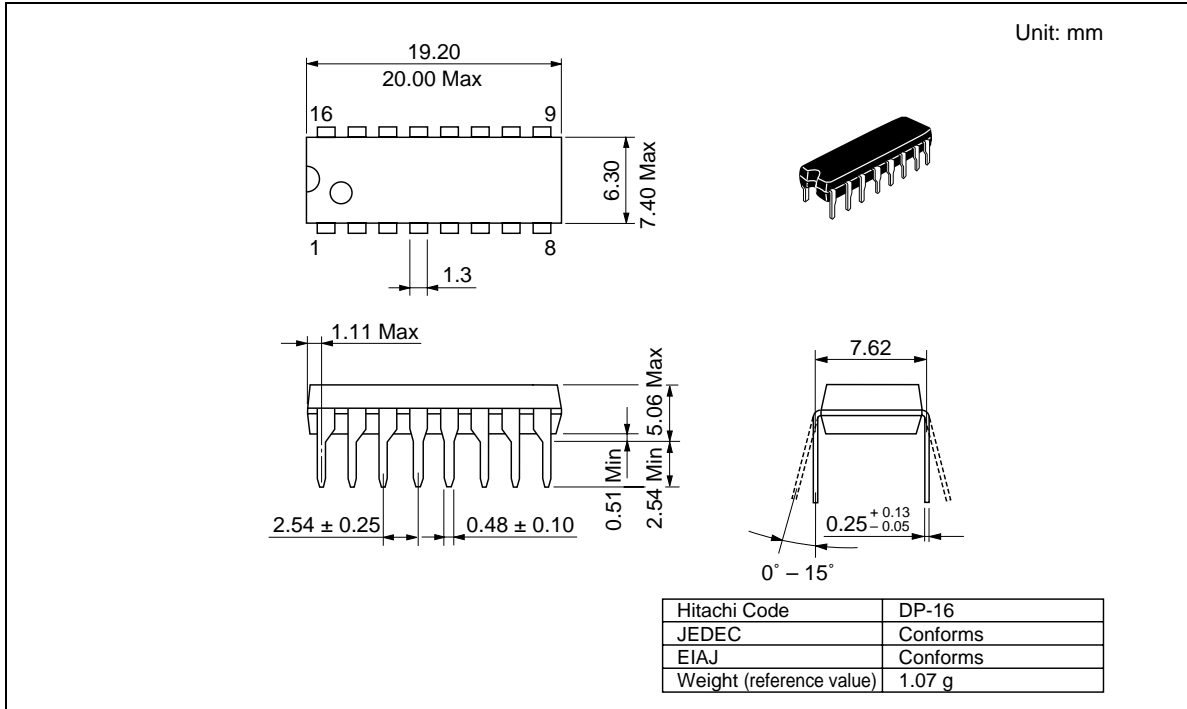

**Disclaimer**

1. Hitachi neither warrants nor grants licenses of any rights of Hitachi's or any third party's patent, copyright, trademark, or other intellectual property rights for information contained in this document. Hitachi bears no responsibility for problems that may arise with third party's rights, including intellectual property rights, in connection with use of the information contained in this document.
2. Products and product specifications may be subject to change without notice. Confirm that you have received the latest product standards or specifications before final design, purchase or use.
3. Hitachi makes every attempt to ensure that its products are of high quality and reliability. However, contact Hitachi's sales office before using the product in an application that demands especially high quality and reliability or where its failure or malfunction may directly threaten human life or cause risk of bodily injury, such as aerospace, aeronautics, nuclear power, combustion control, transportation, traffic, safety equipment or medical equipment for life support.
4. Design your application so that the product is used within the ranges guaranteed by Hitachi particularly for maximum rating, operating supply voltage range, heat radiation characteristics, installation conditions and other characteristics. Hitachi bears no responsibility for failure or damage when used beyond the guaranteed ranges. Even within the guaranteed ranges, consider normally foreseeable failure rates or failure modes in semiconductor devices and employ systemic measures such as fail-safes, so that the equipment incorporating Hitachi product does not cause bodily injury, fire or other consequential damage due to operation of the Hitachi product.
5. This product is not designed to be radiation resistant.
6. No one is permitted to reproduce or duplicate, in any form, the whole or part of this document without written approval from Hitachi.
7. Contact Hitachi's sales office for any questions regarding this document or Hitachi semiconductor products.

**Sales Offices**

---

---

**HITACHI****Hitachi, Ltd.**

Semiconductor & Integrated Circuits.  
Nippon Bldg., 2-6-2, Ohte-machi, Chiyoda-ku, Tokyo 100-0004, Japan  
Tel: Tokyo (03) 3270-2111 Fax: (03) 3270-5109

URL NorthAmerica : <http://semiconductor.hitachi.com/>  
Europe : <http://www.hitachi-eu.com/hel/ecg>  
Asia (Singapore) : <http://www.has.hitachi.com.sg/grp3/sicd/index.htm>  
Asia (Taiwan) : [http://www.hitachi.com.tw/E/Product/SICD\\_Frame.htm](http://www.hitachi.com.tw/E/Product/SICD_Frame.htm)  
Asia (HongKong) : <http://www.hitachi.com.hk/eng/bo/grp3/index.htm>  
Japan : <http://www.hitachi.co.jp/Sicd/indx.htm>

**For further information write to:**

Hitachi Semiconductor  
(America) Inc.  
179 East Tasman Drive,  
San Jose, CA 95134  
Tel: <1> (408) 433-1990  
Fax: <1> (408) 433-0223

Hitachi Europe GmbH  
Electronic components Group  
Dornacher Straße 3  
D-85622 Feldkirchen, Munich  
Germany  
Tel: <49> (89) 9 9180-0  
Fax: <49> (89) 9 29 30 00  
Hitachi Europe Ltd.  
Electronic Components Group.  
Whitebrook Park  
Lower Cookham Road  
Maidenhead  
Berkshire SL6 8YA, United Kingdom  
Tel: <44> (1628) 585000  
Fax: <44> (1628) 778322

Hitachi Asia Pte. Ltd.  
16 Collyer Quay #20-00  
Hitachi Tower  
Singapore 049318  
Tel: 535-2100  
Fax: 535-1533

Hitachi Asia Ltd.  
Taipei Branch Office  
3F, Hung Kuo Building, No.167,  
Tun-Hwa North Road, Taipei (105)  
Tel: <886> (2) 2718-3666  
Fax: <886> (2) 2718-8180

Hitachi Asia (Hong Kong) Ltd.  
Group III (Electronic Components)  
7/F., North Tower, World Finance Centre,  
Harbour City, Canton Road, Tsim Sha Tsui,  
Kowloon, Hong Kong  
Tel: <852> (2) 735 9218  
Fax: <852> (2) 730 0281  
Telex: 40815 HITEC HX

Copyright ' Hitachi, Ltd., 1998. All rights reserved. Printed in Japan.