HA13156

38 W × 4-Channel BTL Power IC

HITACHI

ADE-207-241 (Z)

1st. Edition

July 1997

Description

The HA13156 is four-channel BTL amplifier IC designed for car audio, featuring high output and low distortion, and applicable to digital audio equipment. It provides 38 W output per channel, with a 13.7 V power supply and at Max distortion.

Functions

- 4 ch BTL power amplifiers
- Built-in standby circuit
- Built-in muting circuit
- Built-in protection circuit (surge, T.S.D, and ASO)
- Built-in change booster ON/OFF circuit

Features

- High power for booster circuit
- Popping noise minimized
- Low output noise
- Built-in high reliability protection circuit

HA13156

Block Diagram

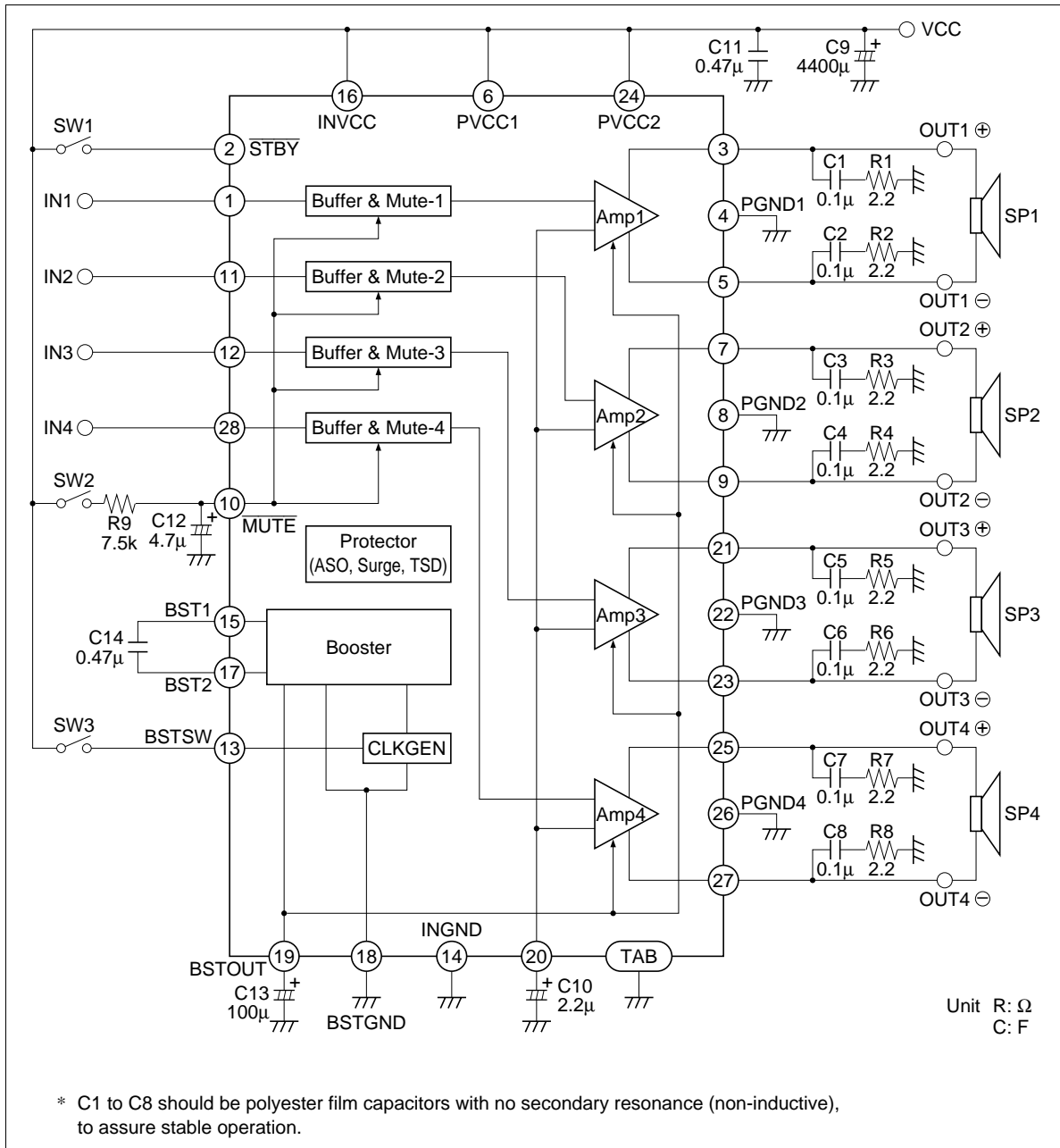

Note: 1. Standby

Power is turned on when a signal of 3.5 V or 0.05 mA is impressed at pin 2.
When pin 2 is open or connected to GND, standby is turned on (output off).

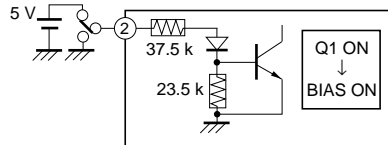

2. Muting

Muting is turned off (output off) when a signal of 3.5 V or 0.2 mA is impressed at pin 10.
When pin 10 is open or connected to GND, muting is turned on (output off).

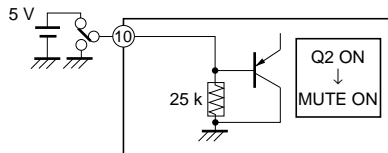

3. DC-DC converter (Booster)

DC-DC converter (Booster) in IC is turned on when a signal of 3.5 V over or 0.04 mA over is impressed at pin 13, and get large max output power.

When pin 13 is open or connected to GND, DC-DC converter (Booster) is turned off.

This IC is generated noise, because built-in DC-DC converter (Booster).

Consequently if you use radio tuner (AM), I recommend DC-DC converter (Booster) off.

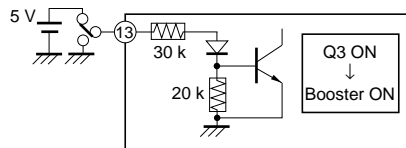

HA13156

Absolute Maximum Ratings

Item	Symbol	Rating	Unit
Operating supply voltage	V_{CC}	18	V
Supply voltage when no signal* ¹	V_{CC} (DC)	26	V
Peak supply voltage* ²	V_{CC} (PEAK)	50	V
Output current* ³	I_O (PEAK)	4	A
Power dissipation* ⁴	P_T	83	W
Junction temperature	T_j	150	°C
Operating temperature	T_{opr}	-30 to +85	°C
Storage temperature	T_{stg}	-55 to +125	°C

- Note: 1. Tolerance within 30 seconds.
 2. Tolerance in surge pulse waveform.
 3. Value per 1 channel.
 4. Value when attached on the infinite heat sink plate at $T_a = 25$ °C.
 The derating curve is as shown in the graph below.

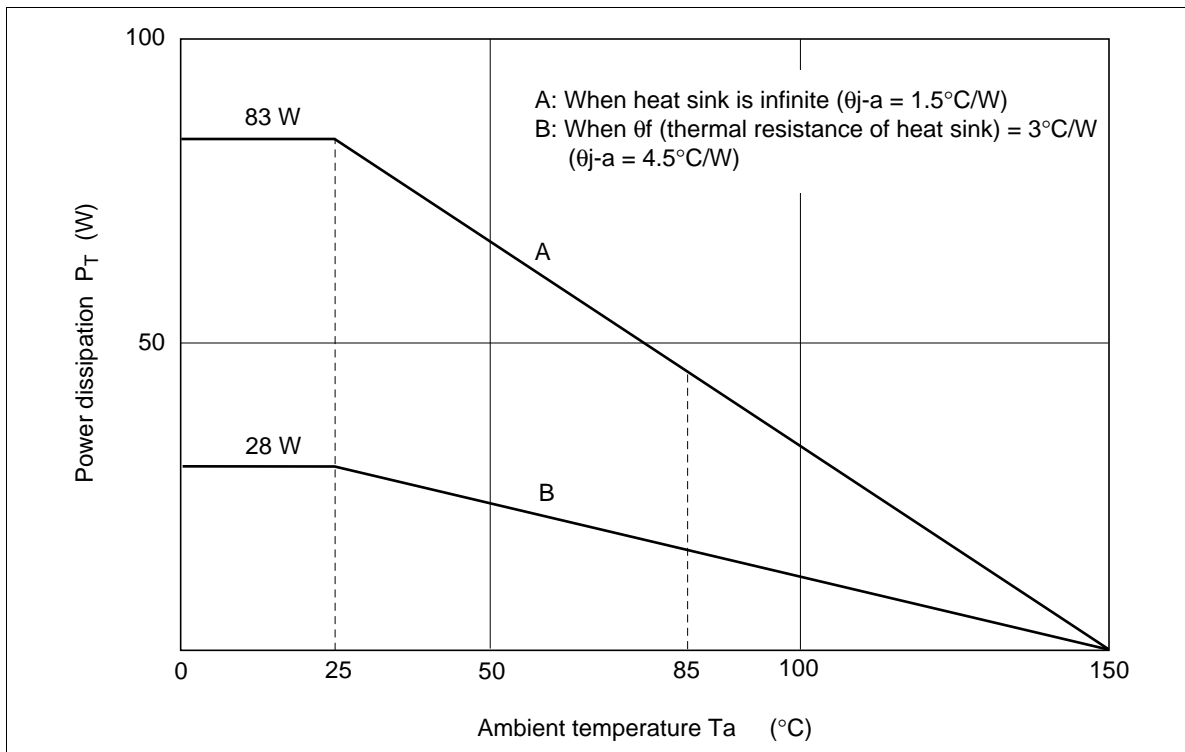

Electrical Characteristics ($V_{CC} = 13.2\text{ V}$, $R_L = 4\ \Omega$, $f = 1\text{ kHz}$, $R_g = 600\ \Omega$, $T_a = 25^\circ\text{C}$, when there is no description in test conditions)

Item	Symbol	Min	Typ	Max	Unit	Test Conditions
Quiescent current1	I_{Q1}	275	380	480	mA	$V_{in} = 0\text{ V}$, boost on, $R_L = \infty$
Quiescent current2	I_{Q2}	190	320	420	mA	$V_{in} = 0\text{ V}$, boost off, $R_L = \infty$
Total harmonic distortion	T.H.D.	—	0.02	0.1	%	$P_o = 3\text{ W}$, boost on, off
Gain	G_V	30.5	32	33.5	dB	
Gain difference between channels	ΔG_V	-1.0	0	1.0	dB	
Rated output power1	P_{O1}	20	23	—	W	$V_{CC} = 13.2\text{ V}$, boost on, $R_L = 4\ \Omega$, THD = 10%
Rated output power2	P_{O2}	17	20	—	W	$V_{CC} = 13.2\text{ V}$, boost off, $R_L = 4\ \Omega$, THD = 10%
Max output power1	P_{OMAX1}	35	38	—	W	$V_{CC} = 13.7\text{ V}$, boost on, $R_L = 4\ \Omega$
Max output power2	P_{OMAX2}	31	34	—	W	$V_{CC} = 13.7\text{ V}$, boost off, $R_L = 4\ \Omega$
Output noise voltage1	WBN1	—	0.15	0.3	mVrms	$R_g = 0\ \Omega$, mute off, BW = 20 to 20 kHz
Output noise voltage2	WBN2	—	0.08	0.2	mVrms	$R_g = 0\ \Omega$, mute on, BW = 20 to 20 kHz
Ripple rejection	SVR	45	55	—	dB	$f = 120\text{ Hz}$
Output offset voltage1	ΔV_{Q1}	-250	0	250	mV	$V_{in} = 0\text{ V}$, mute off
Output offset voltage2	ΔV_{Q2}	-250	0	250	mV	$V_{in} = 0\text{ V}$, change value of mute on → off
Standby current	I_{ST}	—	1	10	μA	boost off
Standby control voltage (high)	V_{STH}	3.5	—	V_{CC}	V	
Standby control voltage (low)	V_{STL}	0	—	1.5	V	
Muting control voltage (high)	V_{MH}	3.5	—	V_{CC}	V	
Muting control voltage (low)	V_{ML}	0	—	1.5	V	
Boost control voltage (high)	V_{BH}	3.5	—	V_{CC}	V	
Boost control voltage (low)	V_{BL}	0	—	1.5	V	
Muting attenuation	ATTM	70	90	—	dB	$V_{out} = 6.7\text{ Vrms}$
Channel cross talk	C.T.	60	80	—	dB	$V_{out} = 6.7\text{ Vrms}$
Input impedance	Z_{in}	18	25	33	$k\Omega$	
Input voltage muted completely	ATTin	7	—	—	Vp-p	

Note: boost on; Boost control voltage (high),
mute on; Muting control voltage (low)

HA13156

Characteristic Curves

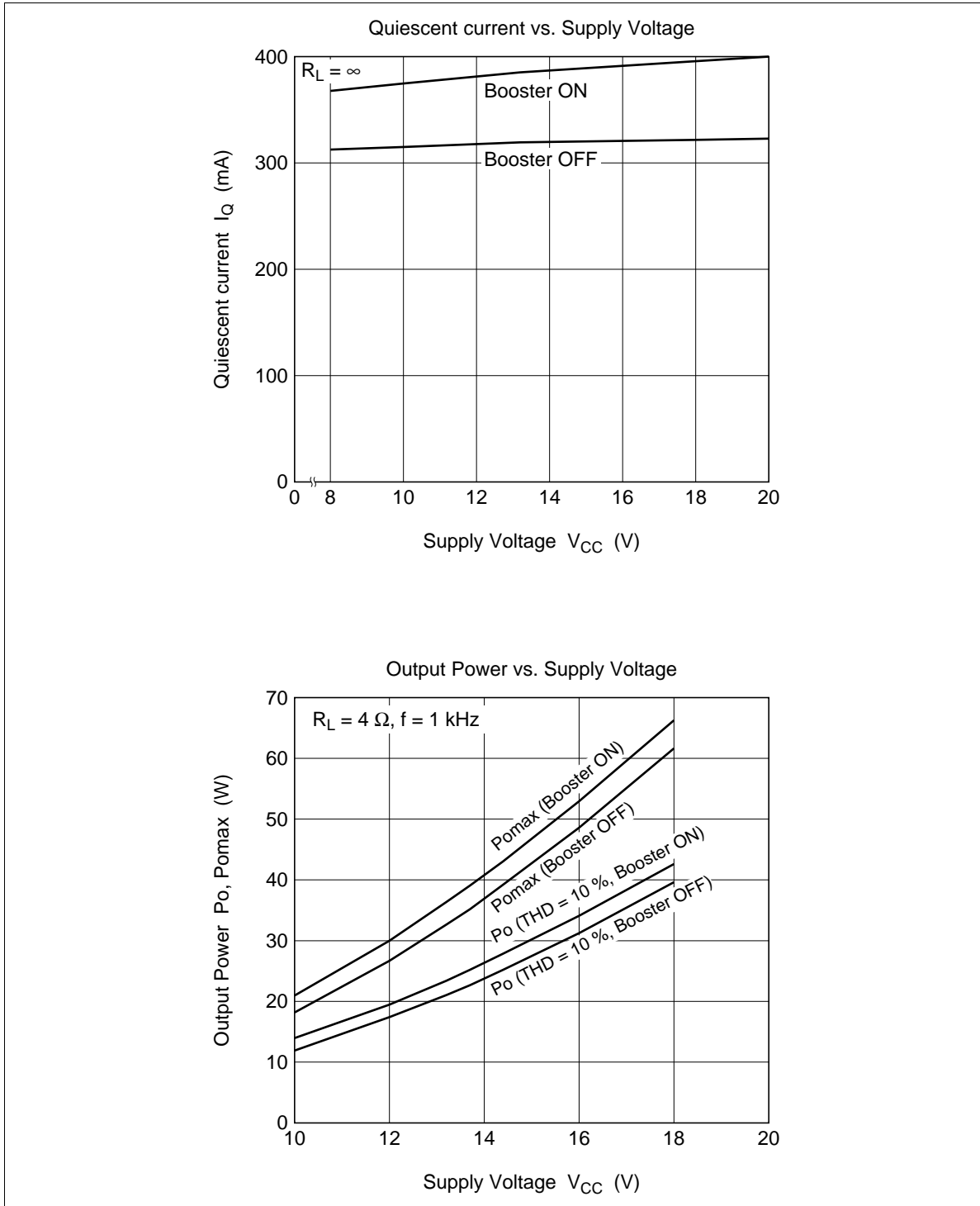

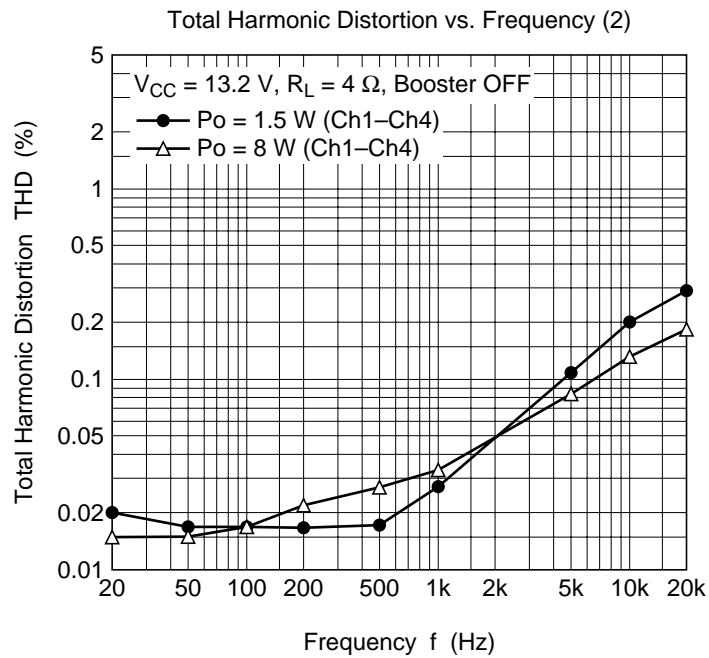
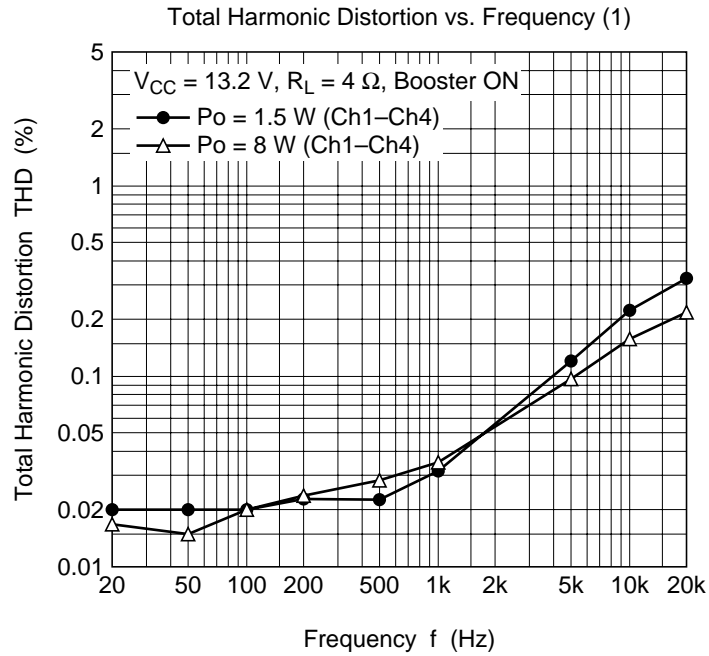

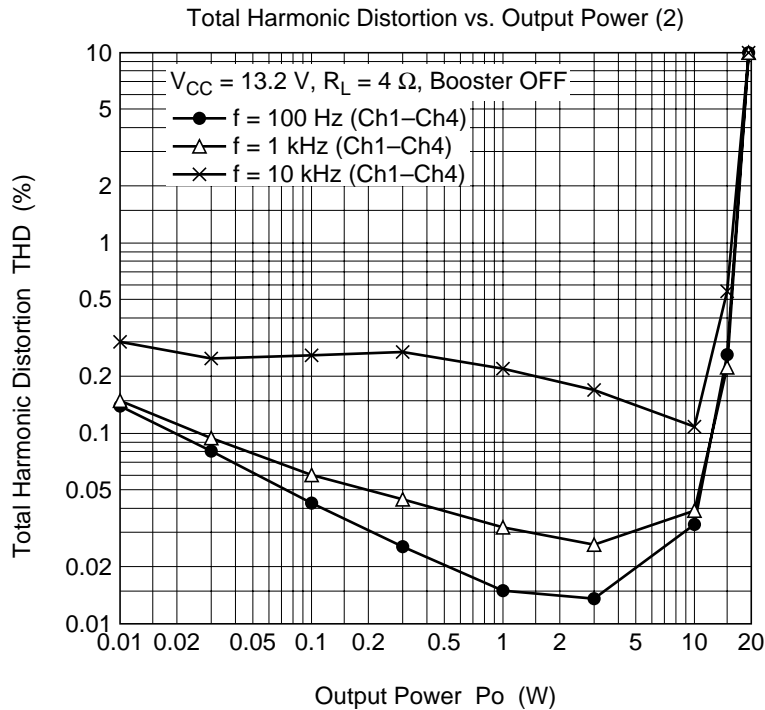
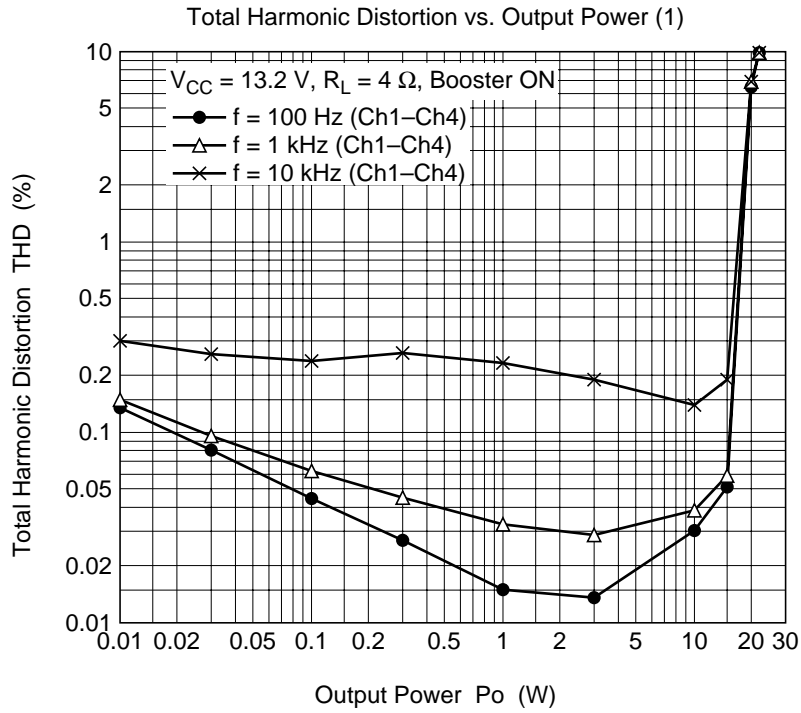

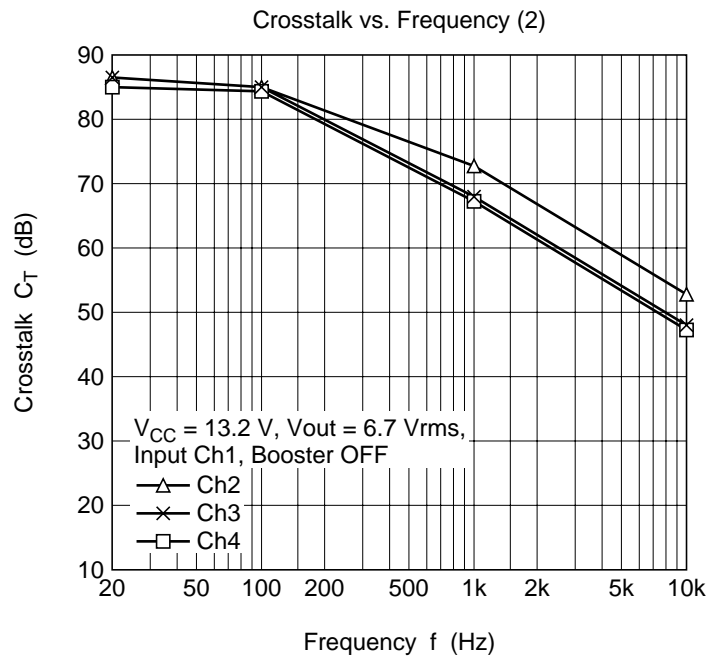
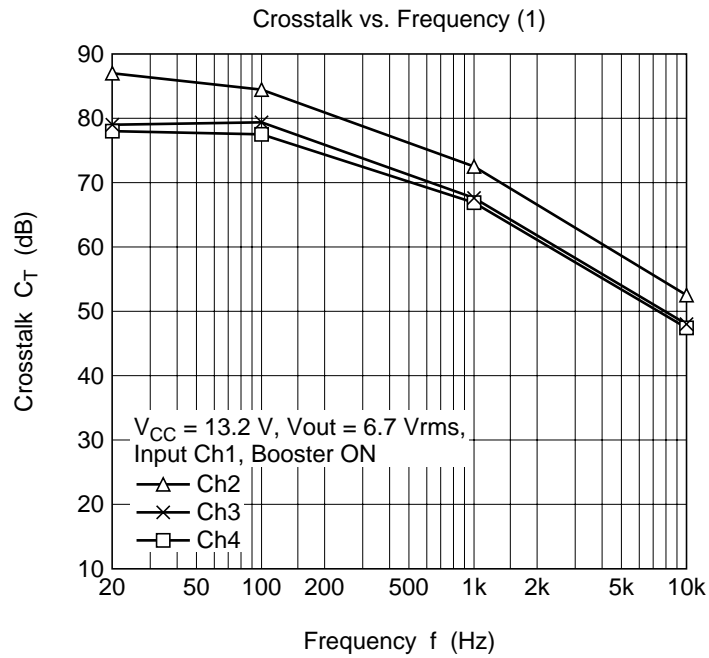

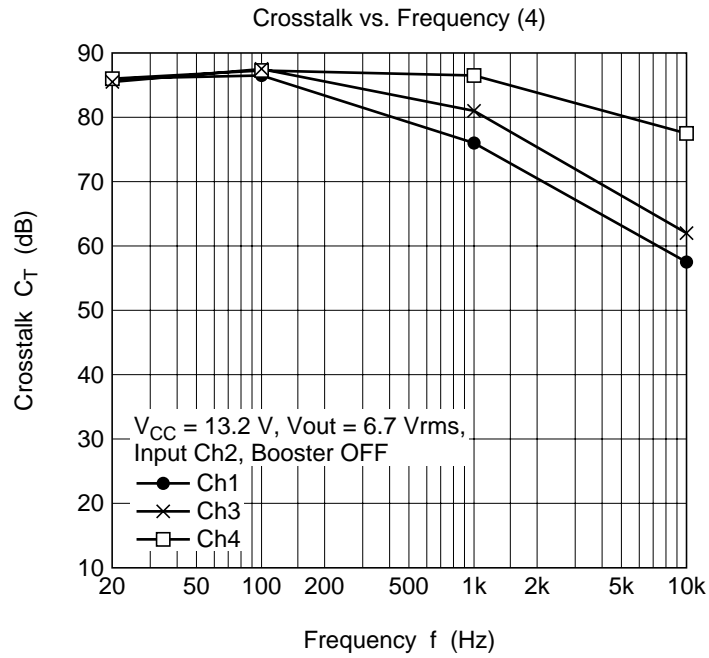
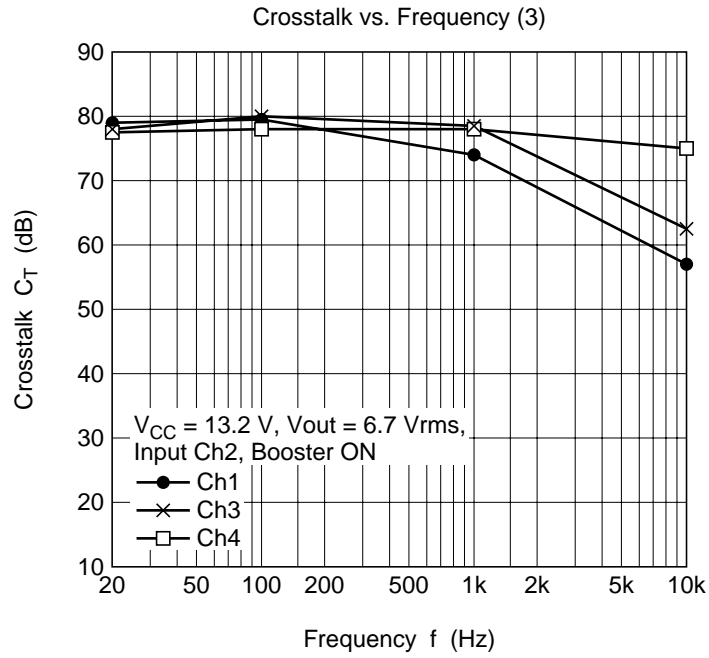

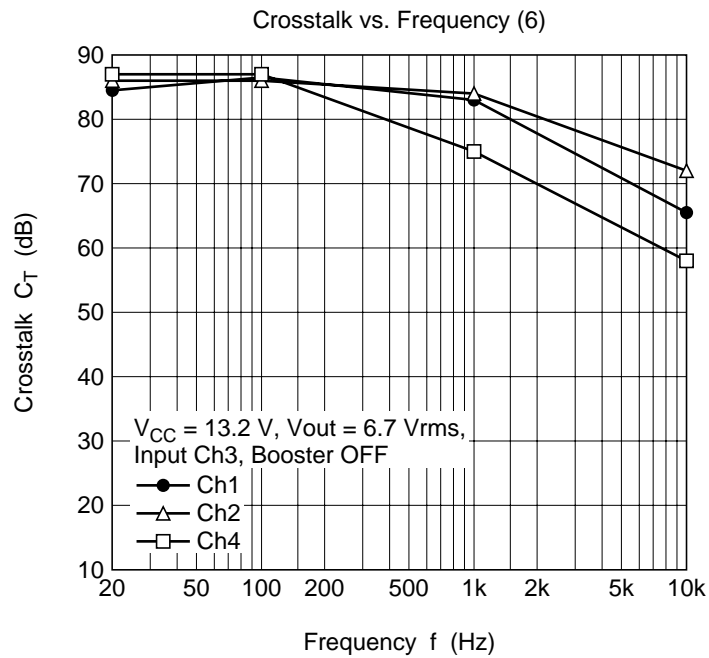
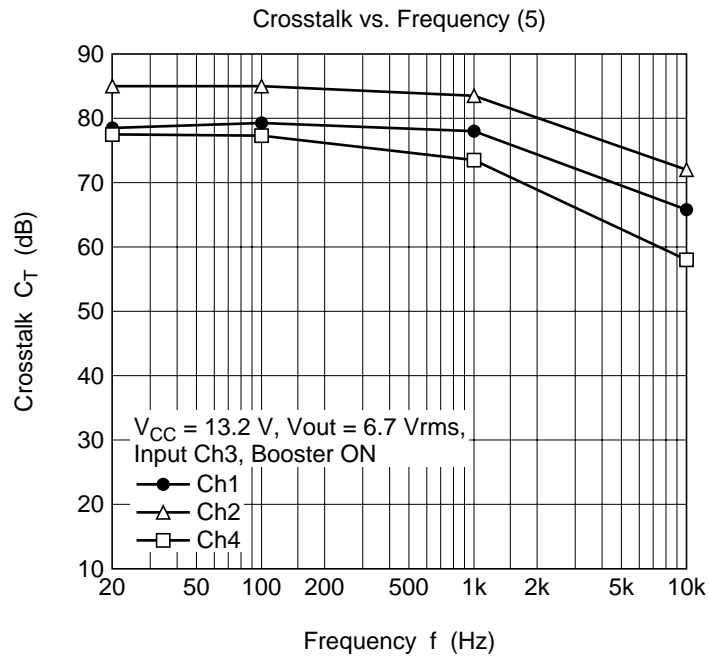

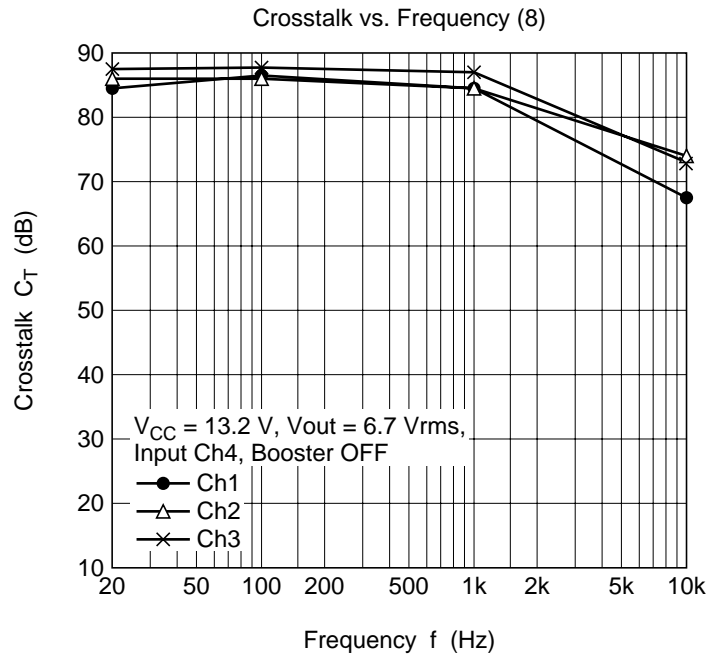
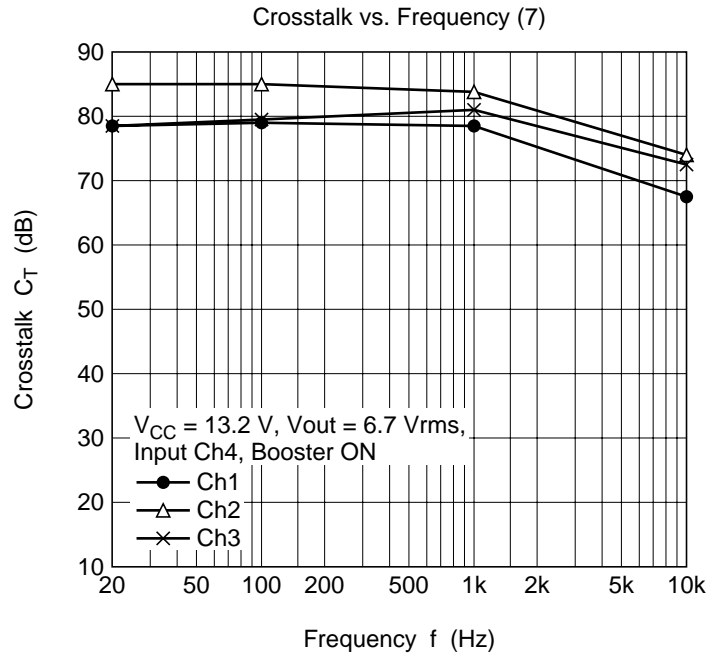

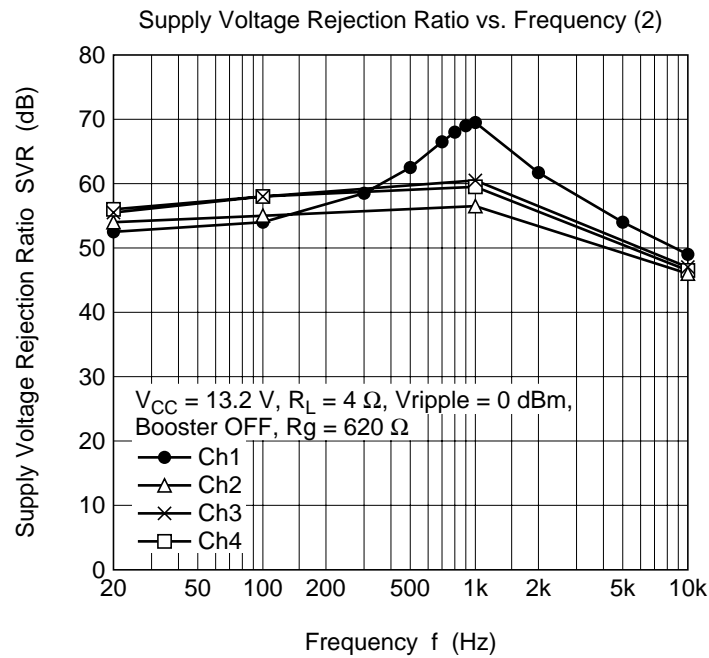
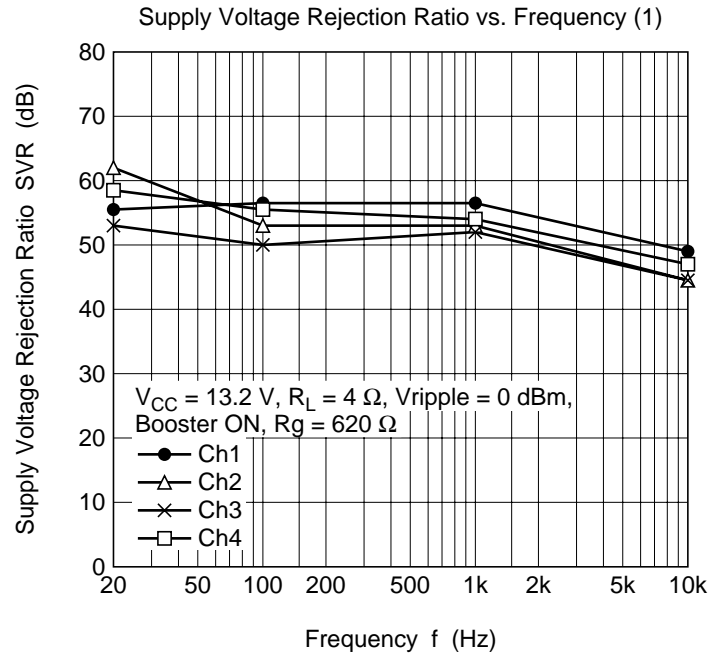

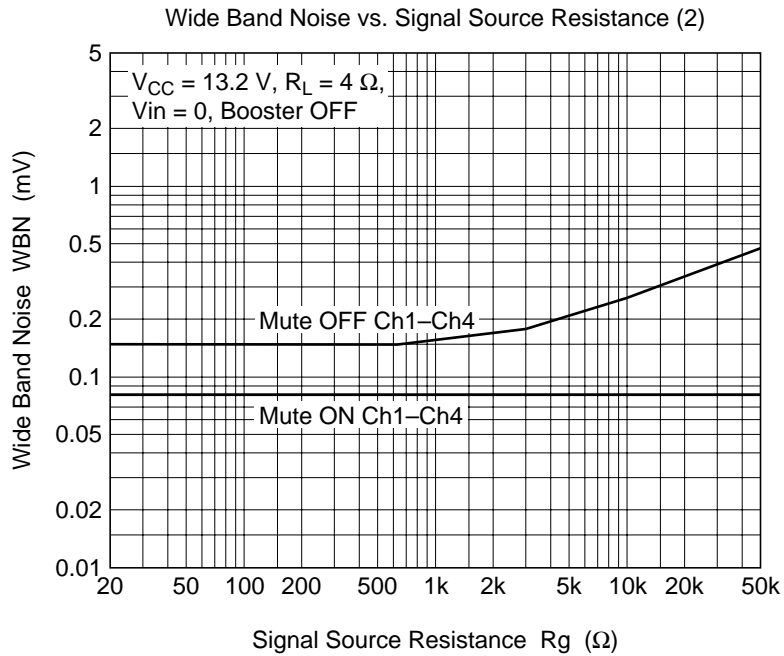
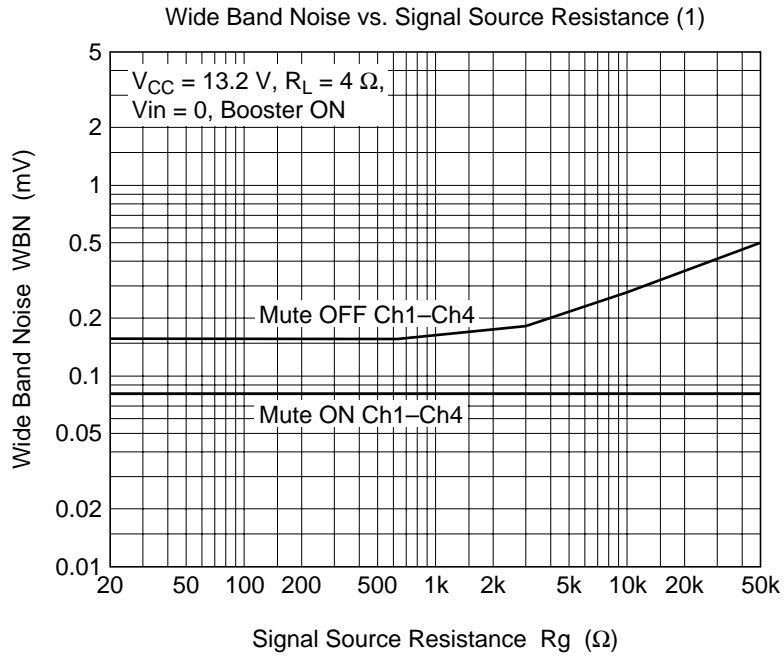

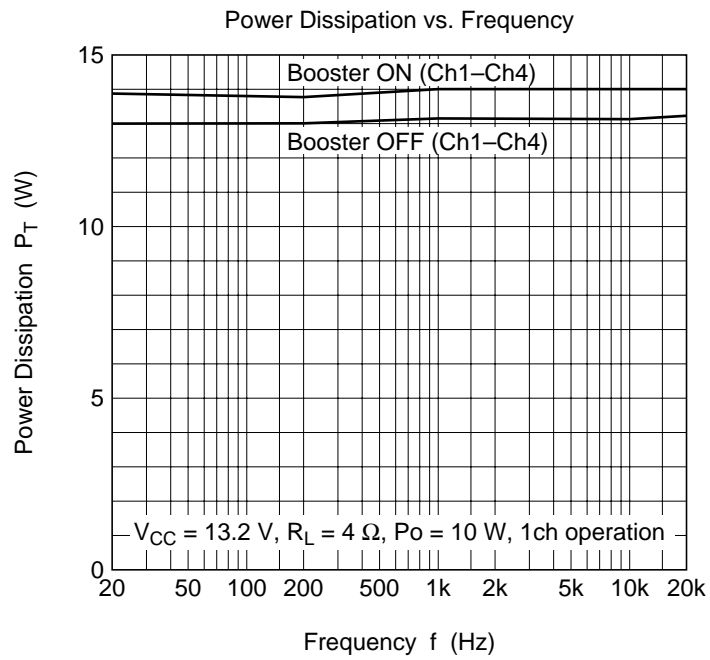
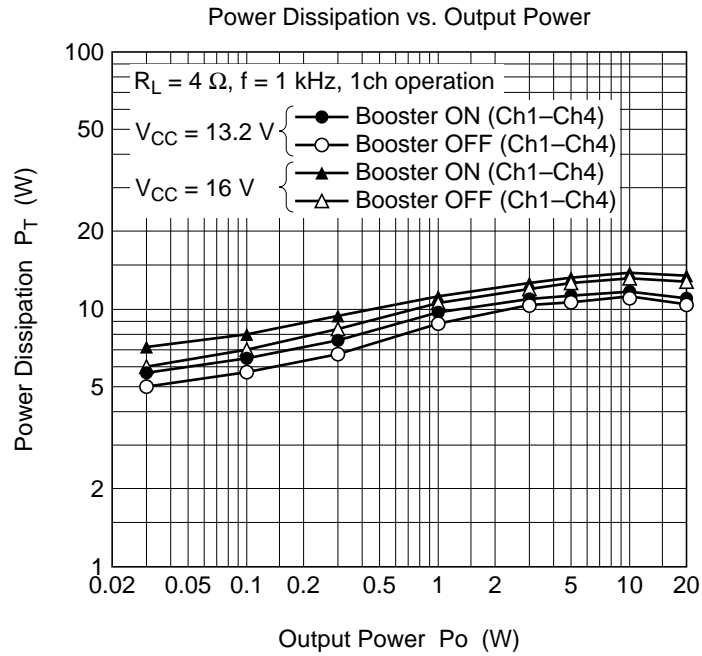

HA13156

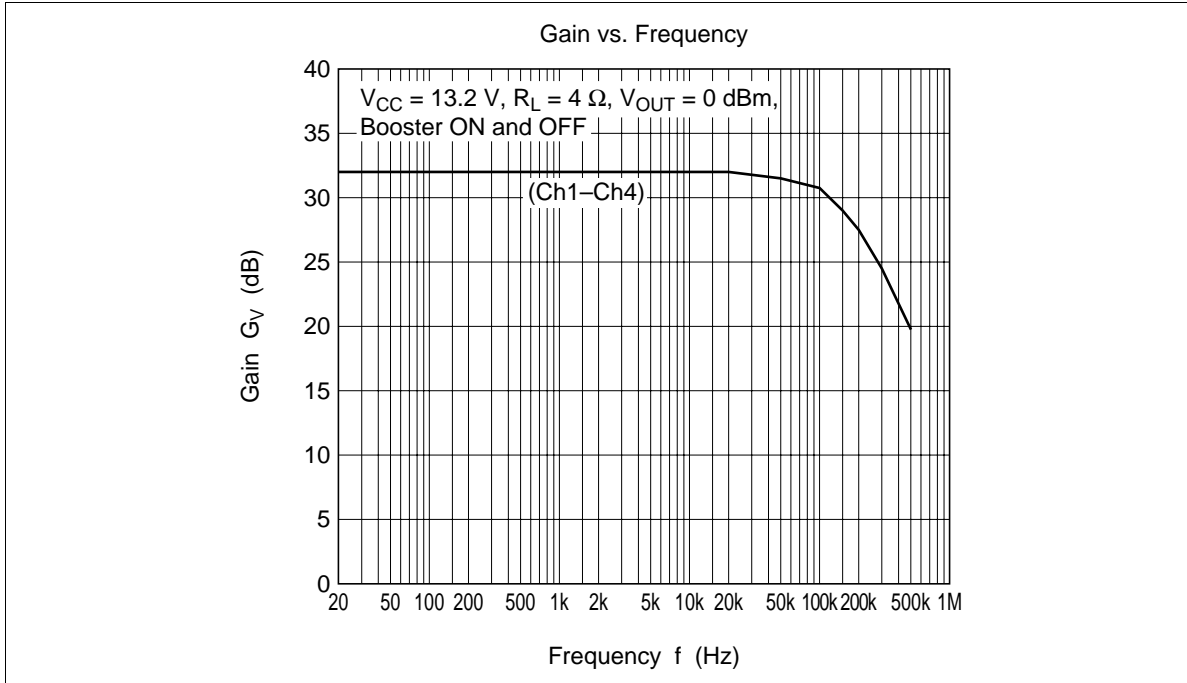

Package Dimensions

Unit: mm

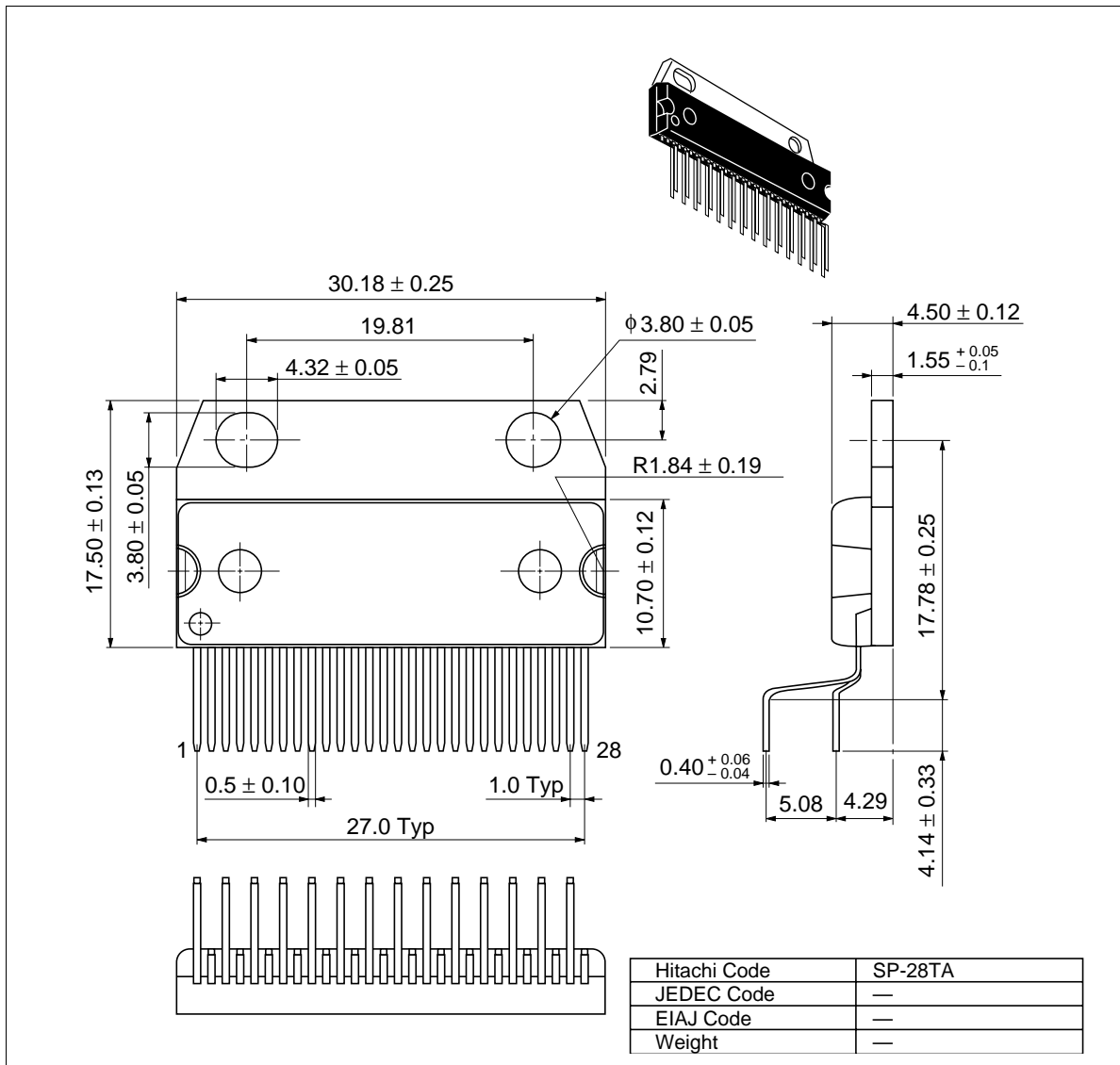

Cautions

1. Hitachi neither warrants nor grants licenses of any rights of Hitachi's or any third party's patent, copyright, trademark, or other intellectual property rights for information contained in this document. Hitachi bears no responsibility for problems that may arise with third party's rights, including intellectual property rights, in connection with use of the information contained in this document.
2. Products and product specifications may be subject to change without notice. Confirm that you have received the latest product standards or specifications before final design, purchase or use.
3. Hitachi makes every attempt to ensure that its products are of high quality and reliability. However, contact Hitachi's sales office before using the product in an application that demands especially high quality and reliability or where its failure or malfunction may directly threaten human life or cause risk of bodily injury, such as aerospace, aeronautics, nuclear power, combustion control, transportation, traffic, safety equipment or medical equipment for life support.
4. Design your application so that the product is used within the ranges guaranteed by Hitachi particularly for maximum rating, operating supply voltage range, heat radiation characteristics, installation conditions and other characteristics. Hitachi bears no responsibility for failure or damage when used beyond the guaranteed ranges. Even within the guaranteed ranges, consider normally foreseeable failure rates or failure modes in semiconductor devices and employ systemic measures such as fail-safes, so that the equipment incorporating Hitachi product does not cause bodily injury, fire or other consequential damage due to operation of the Hitachi product.
5. This product is not designed to be radiation resistant.
6. No one is permitted to reproduce or duplicate, in any form, the whole or part of this document without written approval from Hitachi.
7. Contact Hitachi's sales office for any questions regarding this document or Hitachi semiconductor products.

HITACHI

Hitachi, Ltd.

Semiconductor & Integrated Circuits.
Nippon Bldg., 2-6-2, Ohte-machi, Chiyoda-ku, Tokyo 100-0004, Japan
Tel: Tokyo (03) 3270-2111 Fax: (03) 3270-5109

URL NorthAmerica : <http://semiconductor.hitachi.com/>
 Europe : <http://www.hitachi-eu.com/hel/ecg>
 Asia (Singapore) : <http://www.has.hitachi.com.sg/grp3/sicd/index.htm>
 Asia (Taiwan) : http://www.hitachi.com.tw/E/Product/SICD_Frame.htm
 Asia (HongKong) : <http://www.hitachi.com.hk/eng/bo/grp3/index.htm>
 Japan : <http://www.hitachi.co.jp/Sicd/indx.htm>

For further information write to:

Hitachi Semiconductor
(America) Inc.
179 East Tasman Drive,
San Jose, CA 95134
Tel: <1> (408) 433-1990
Fax: <1> (408) 433-0223

Hitachi Europe GmbH
Electronic components Group
Dornacher StraÙe 3
D-85622 Feldkirchen, Munich
Germany
Tel: <49> (89) 9 9180-0
Fax: <49> (89) 9 29 30 00

Hitachi Europe Ltd.
Electronic Components Group.
Whitebrook Park
Lower Cookham Road
Maidenhead
Berkshire SL6 8YA, United Kingdom
Tel: <44> (1628) 585000
Fax: <44> (1628) 778322

Hitachi Asia Pte. Ltd.
16 Collyer Quay #20-00
Hitachi Tower
Singapore 049318
Tel: 535-2100
Fax: 535-1533

Hitachi Asia Ltd.
Taipei Branch Office
3F, Hung Kuo Building, No.167,
Tun-Hwa North Road, Taipei (105)
Tel: <886> (2) 2718-3666
Fax: <886> (2) 2718-8180

Hitachi Asia (Hong Kong) Ltd.
Group III (Electronic Components)
7/F., North Tower, World Finance Centre,
Harbour City, Canton Road, Tsim Sha Tsui,
Kowloon, Hong Kong
Tel: <852> (2) 735 9218
Fax: <852> (2) 730 0281
Telex: 40815 HITEC HX