HA13164A

Multiple Voltage Regulator

HITACHI

ADE-207-342 (Z)

Rev.0
Jun. 2001

General Description

The HA13164A is a compact multiple voltage regulator for car audio system. The outputs of this IC output consist of regulated 5.7 V output for a microcontroller, regulated 8 V output for CD driver, regulated 9.0 V output for audio control, regulated 10 V output for illuminations and regulated 5 V output, VCC-dependent output for external output and VCC-dependent output for remort-ANT.

Functions

General

- ACC power monitor circuit is built-in as to detect low voltage.
- Low saturation output (PNP output) used for audio output.
- Adjustable voltage for illumination output by changing an external resister.

Protections

- Output current limit circuit to avoid device destruction caused by shorted output, etc.
- High surge input protector against VCC and ACC.
- Built in a thermal shutdown circuit to prevent against the thermal destruction.

HA13164A

Pin Description and Equivalent Circuit

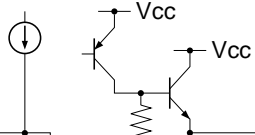
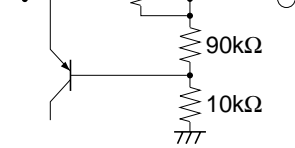
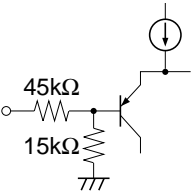
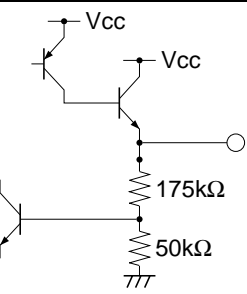
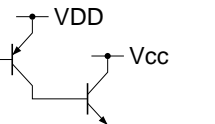
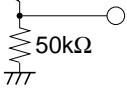
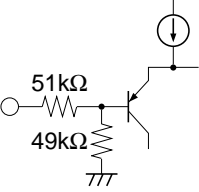
Pin			Equivalent Circuit	Function		
No.	Pin Name	Specification		Normal Operation	TSD	Surge Input
1	EXT OUT	VCC-1V/300mA min		Output voltage is VCC-1 V when M or H level applied to CTRL pin.	0V	0V
2	ANT OUT	VCC-1V/300mA min		Output voltage is VCC-1 V when M or H level to CTRL pin and H level to ANT-CTRL.	0V	0V
3	ACCIN	—		Connected to ACC.	—	—
4	VDD OUT	5.7V/100mA min		Regular 5.7V.	5.7V	0V
5	SW5VOUT	5.0V/100mA min		Output voltage is 5V when M or H level applied to CTRL pin.	0V	0V
6	COMPOUT	5.0V/100mA min		Output for ACC detector	0V	0V
7	ANT CTRL	—		L: ANT output OFF H: ANT output ON	—	—

Pin Description and Equivalent Circuit (cont)

Pin No.	Pin Name	Specification	Equivalent Circuit	Function		
				Normal Operation	TSD	Surge Input
8	VCC	—		Connected to VCC	—	—
9	BATT DET	—		Low battery detect.	Detect	Not detect
10	AUDIOOUT	9.0V/500mA min		Output voltage is 9V when M or H level applied to CTRL pin.	0V	0V
11	CTRL	—		L: BIAS OFF M: BIAS ON H: CD ON	—	—
12	CD OUT	8.0V/1.3A min		Output voltage is 8V when H level applied to CTRL pin.	0V	0V
13	ILM AJ	—		Adjustment pin for ILM output voltage.	—	—
14	ILM OUT	9.85V/500mA min		Output voltage is 10V when M or H level applied to CTRL pin	0V	0V
15	GND	—		Connected to GND	—	—

HA13164A

Timing Chart

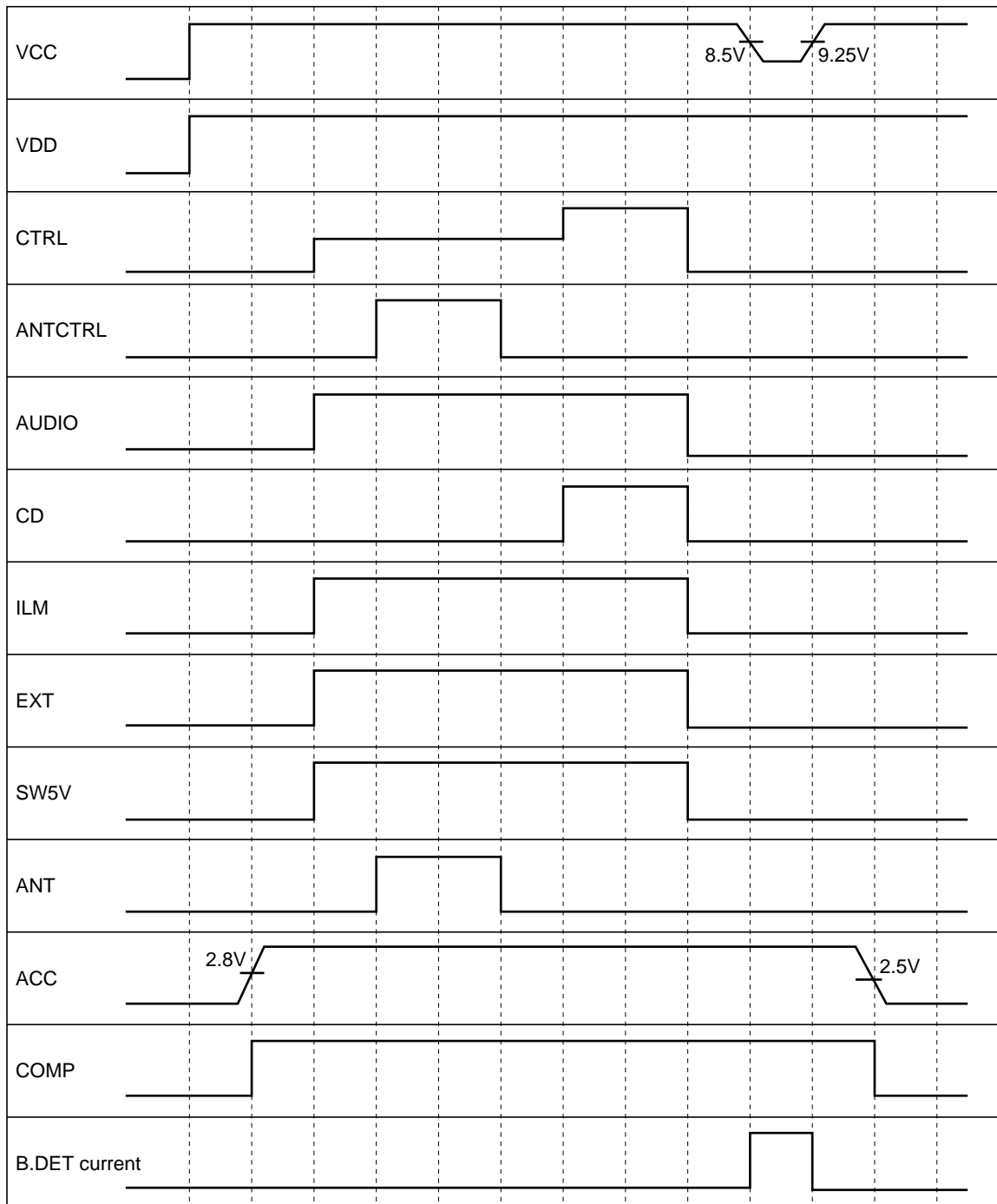

Block Diagram

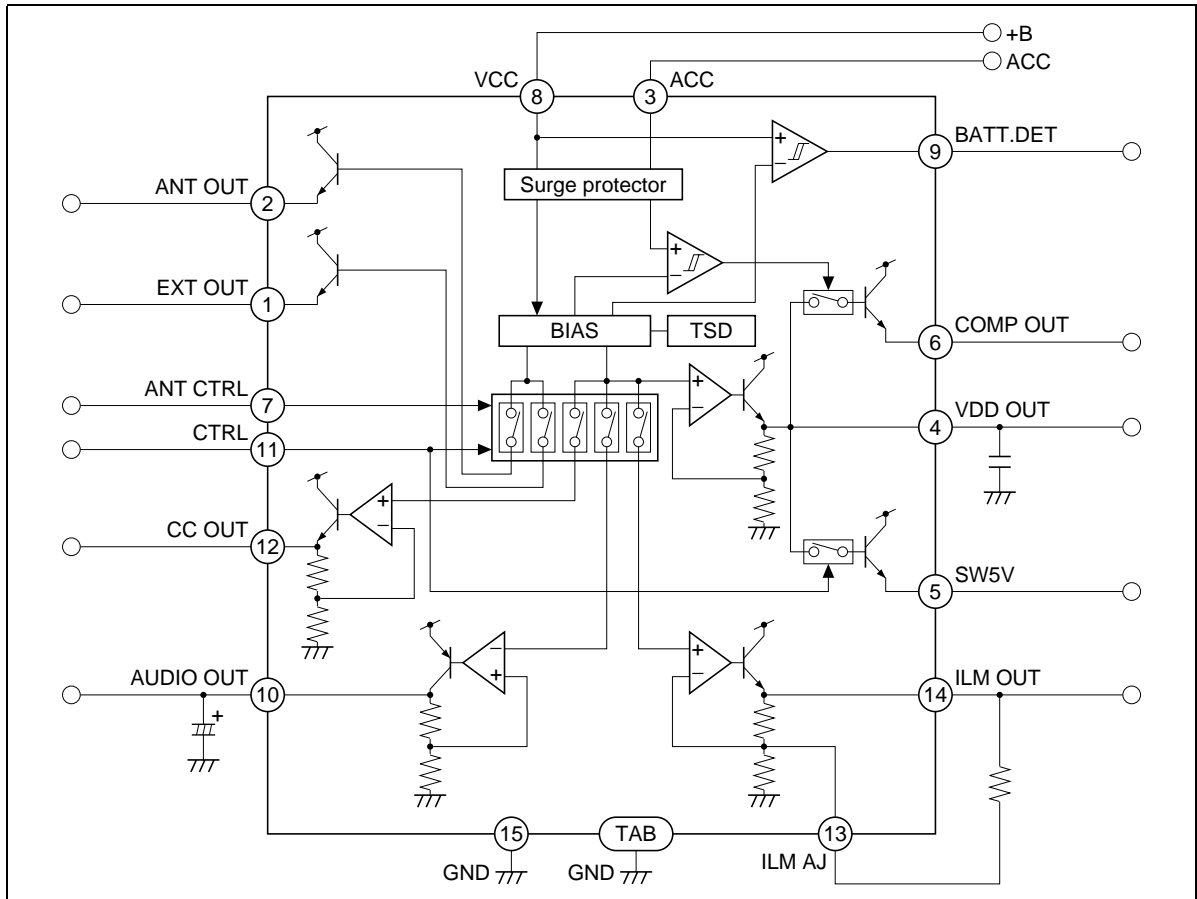

HA13164A

Absolute Maximum Ratings

(Ta = 25°C)

Item	Symbol	Value	Unit	Note
Operating power supply voltage	Vcc	18	V	
DC supply voltage	Vcc(DC)	26	V	1
Peak voltage	Vcc(PEAK)	50	V	2
Power dissipation	Pd	36	W	3
Junction temperature	Tj	150	°C	
Operating temperature	Topr	-40 to +85	°C	
Storage temperature	Tstg	-55 to +125	°C	

Notes: Recommended power supply voltage range 10V to 16V.

1. Applied time is less than 30 sec.
2. Surge pulse as input.
3. Ta=25°C. :Permissible power dissipation when using a heat sink of infinite area. Refer to the derating curves below.

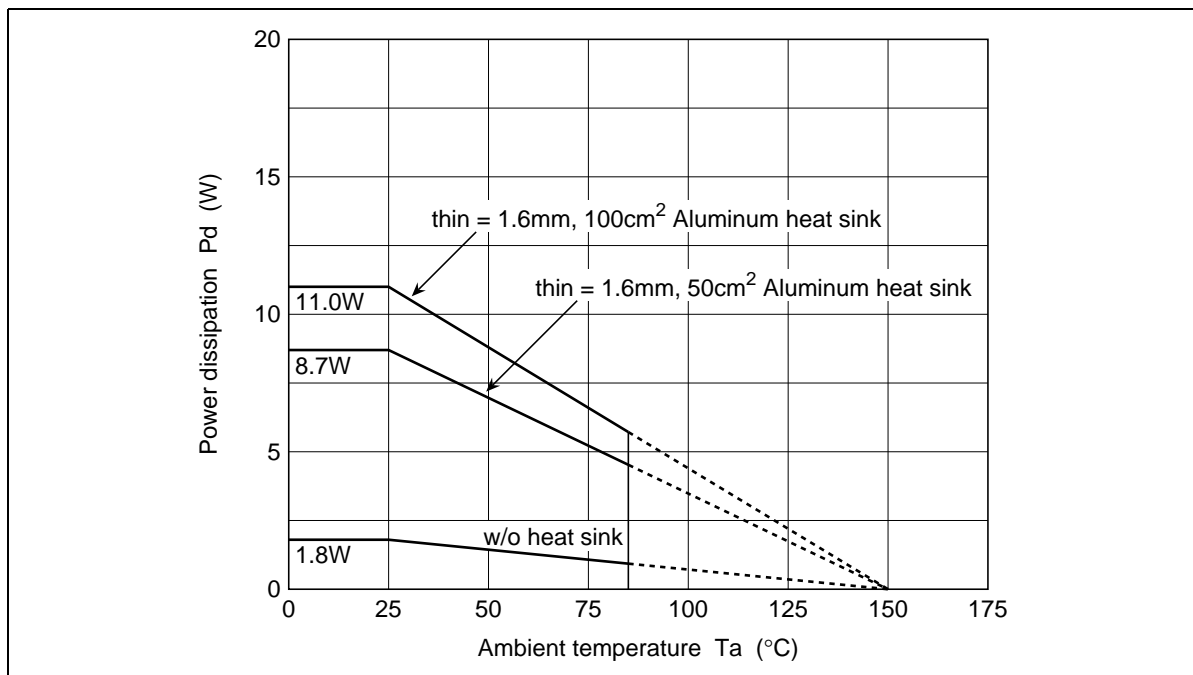

Electrical Characteristics

(unless otherwise noted, $V_{CC} = 13.2\text{ V}$, $T_a = 25^\circ\text{C}$)

Item	Symbol	Min	Typ	Max	Unit	Test Condition	
Standby current	IST	—	460	700	μA	ACC = 0V, CTRL = 0V	
CTRL L level (STBY mode)	VCL	0	—	1.0	V		
CTRL M level (CD OFF mode)	VCM	2.0	—	3.0	V		
CTRL H level (CD ON mode)	VCH	4.0	—	—	V		
ANT CTRL L level (ANTOFF mode)	VACL	0	—	2.0	V		
ANT CTRL H level (ANT ON mode)	VACH	3.0	—	—	V		
VDD OUT	Output voltage	Vo1	5.4	5.7	6.0	V	Io1 = 80mA
	Voltage regulation	$\Delta\text{Vo}11$	—	10	50	mV	$V_{CC} = 10$ to 16V, Io1 = 80mA
	Load regulation	$\Delta\text{Vo}12$	—	50	100	mV	Io1 = 0 to 80mA
	Minimum I/O voltage differential	$\Delta\text{Vo}13$	—	1.0	1.5	V	Io1 = 80mA
	Output current capacity	Io1	100	250	—	mA	Vo1 \geq 5.4V
	Ripple rejection ratio	SVR1	50	60	—	dB	f = 100Hz, Io1 = 80mA
CD OUT	Output voltage 2	Vo2	7.6	8.0	8.4	V	Io2 = 1.0A
	Voltage regulation	$\Delta\text{Vo}21$	—	40	100	mV	$V_{CC} = 10$ to 16V, Io2 = 1.0A
	Load regulation	$\Delta\text{Vo}22$	—	70	150	mV	Io2 = 10m to 1.0A
	Minimum I/O voltage differential	$\Delta\text{Vo}23$	—	1.0	1.5	V	Io2 = 1.0A
	Output current capacity	Io2	1.3	2.0	—	A	Vo2 \geq 7.6V
	Ripple rejection ratio	SVR2	40	45	—	dB	f = 100Hz, Io2 = 1.0A
AUDIO OUT	Output voltage 3	Vo3	8.5	9.0	9.5	V	Io3 = 400mA
	Voltage regulation	$\Delta\text{Vo}31$	—	30	90	mV	$V_{CC} = 10$ to 16V, Io3 = 400mA
	Load regulation	$\Delta\text{Vo}32$	—	100	200	mV	Io3 = 10 to 400mA
	Minimum I/O voltage differential	$\Delta\text{Vo}33$	—	0.4	0.9	V	Io3 = 400mA
	Output current capacity	Io3	500	850	—	mA	Vo3 \geq 8.5V
	Ripple rejection ratio	SVR3	45	50	—	dB	f = 100Hz, Io3 = 400mA
ILM OUT	Output voltage 4	Vo4	9.35	9.85	10.35	V	Io4 = 400mA
	Voltage regulation	$\Delta\text{Vo}41$	—	40	100	mV	$V_{CC} = 12.5$ to 16V, Io4 = 400mA
	Load regulation	$\Delta\text{Vo}42$	—	50	100	mV	Io4 = 10 to 400mA
	Minimum I/O voltage differential	$\Delta\text{Vo}43$	—	1.0	1.5	V	Io4 = 400mA
	Output current capacity	Io4	500	900	—	mA	Vo4 \geq 9.35V
	Ripple rejection ratio	SVR4	35	40	—	dB	f = 100Hz, Io4 = 400mA
EXT12 OUT	Differential I/O voltage	$\Delta\text{Vo}51$	—	1.0	1.5	V	Io5 = 300mA
	Load regulation	$\Delta\text{Vo}52$	—	350	600	mV	Io5 = 10 to 300mA
	Output current capacity	Io5	300	500	—	mA	Vo5 \geq 11.7V

HA13164A

Electrical Characteristics (cont)

(unless otherwise noted, $V_{CC} = 13.2\text{ V}$, $T_a = 25^\circ\text{C}$)

Item		Symbol	Min	Typ	Max	Unit	Test Condition
ANT OUT	Differential I/O voltage	ΔV_{o61}	—	1.0	1.5	V	$I_{o6} = 300\text{mA}$
	Load regulation	ΔV_{o62}	—	350	600	mV	$I_{o6} = 10\text{ to }300\text{mA}$
	Output current capacity	I_{o6}	300	500	—	mA	$V_{o6} \geq 11.7\text{V}$
SW5V OUT	Output voltage	V_{o7}	4.6	5.0	5.4	V	$I_{o7} = 80\text{mA}$, VDD = no load
	Output current capacity	I_{o7}	100	300	—	mA	$V_{o7} \geq 4.6\text{V}$
ACC OUT	Output voltage	V_{o8}	4.6	5.0	5.4	V	$I_{o8} = 40\text{mA}$, VDD = no load
	Output current capacity	I_{o8}	100	300	—	mA	$V_{o8} \geq 4.6\text{V}$
	Rise threshold voltage	V_{THH8}	2.6	2.8	3.0	V	
	Hysteresis range	ΔV_{TH8}	0.2	0.3	0.4	V	
BATT. DET	Threshold voltage	V_{THH9}	8.1	8.5	8.9	V	
	Hysteresis range	ΔV_{TH9}	0.55	0.75	0.95	V	
	Output current capacity	I_{o9}	200	—	—	μA	$V_o = 0.3\text{V}$

Evaluation Circuit

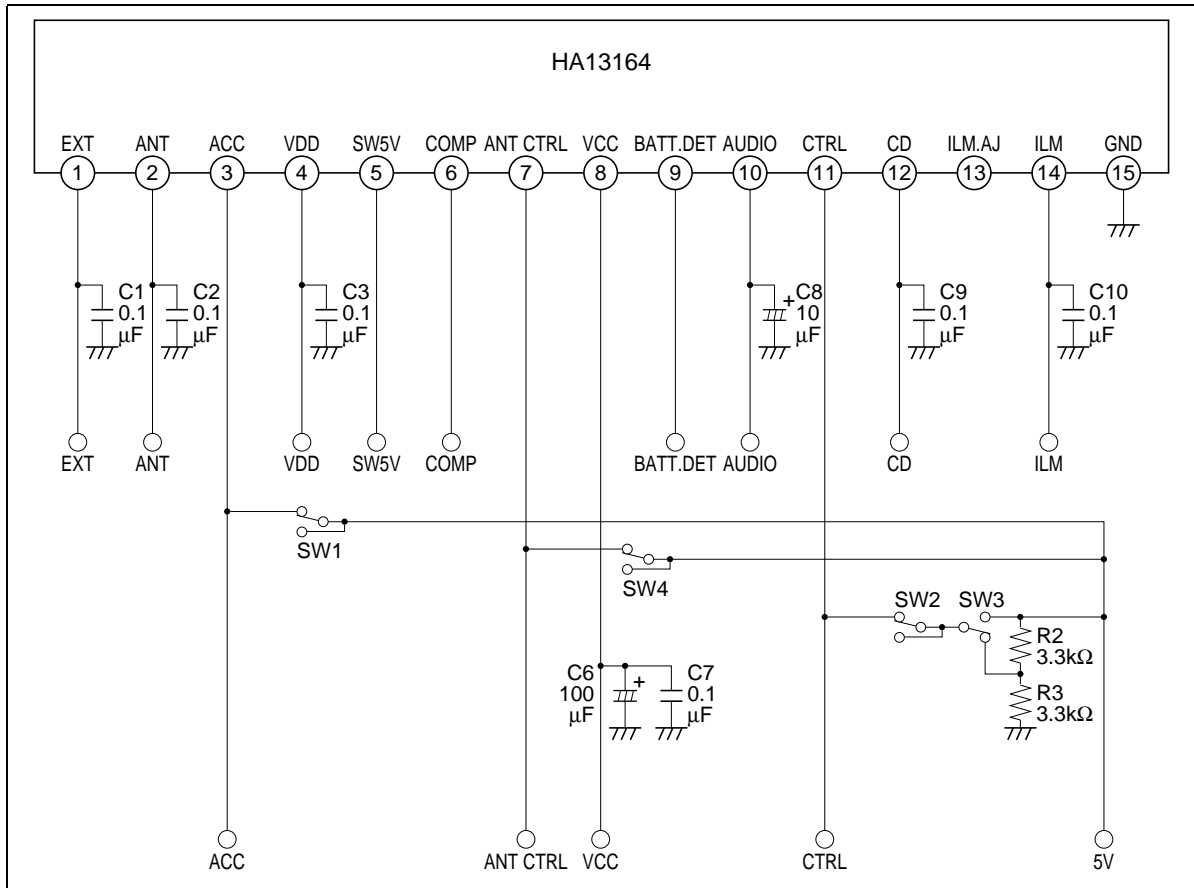

Main Characteristic

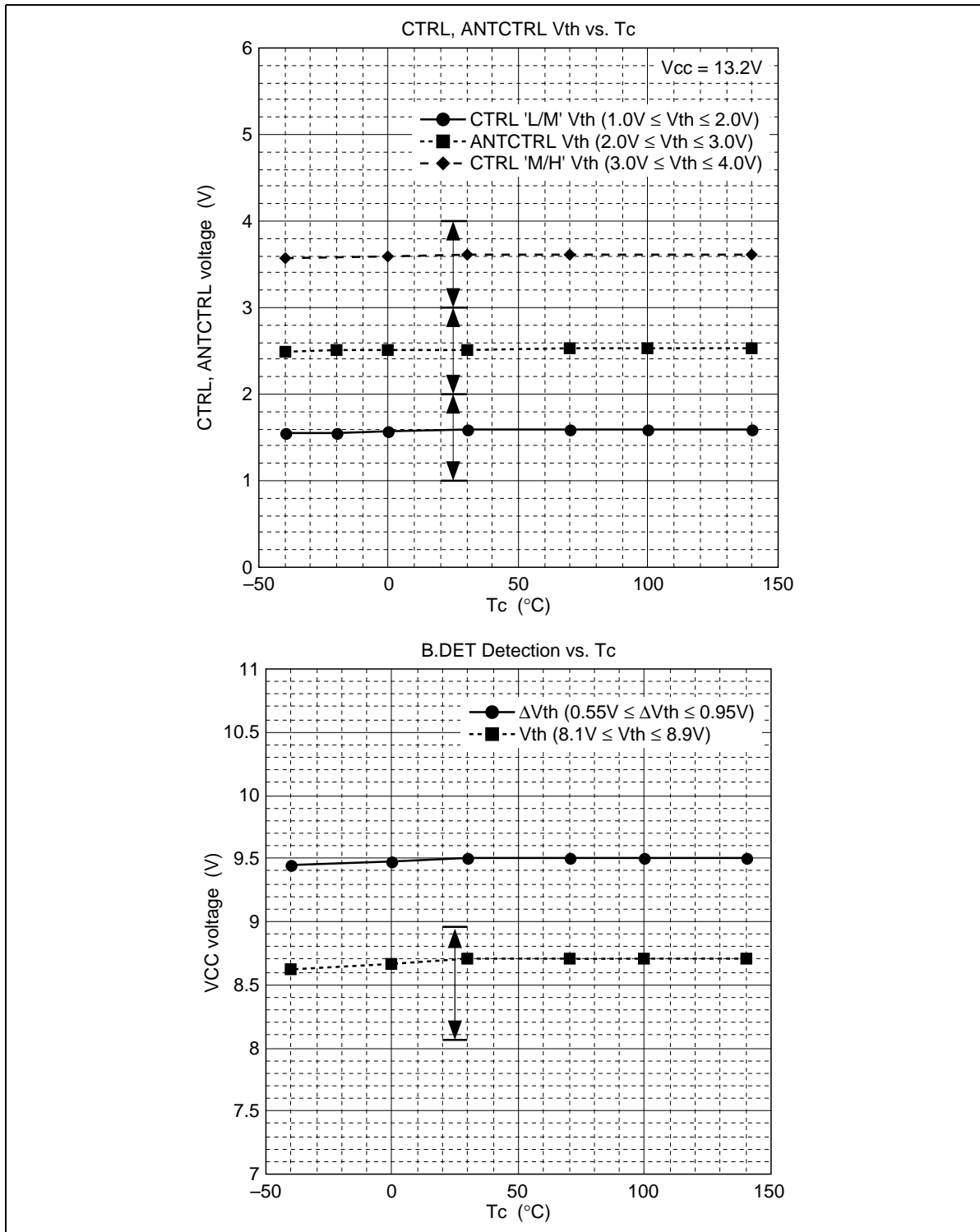

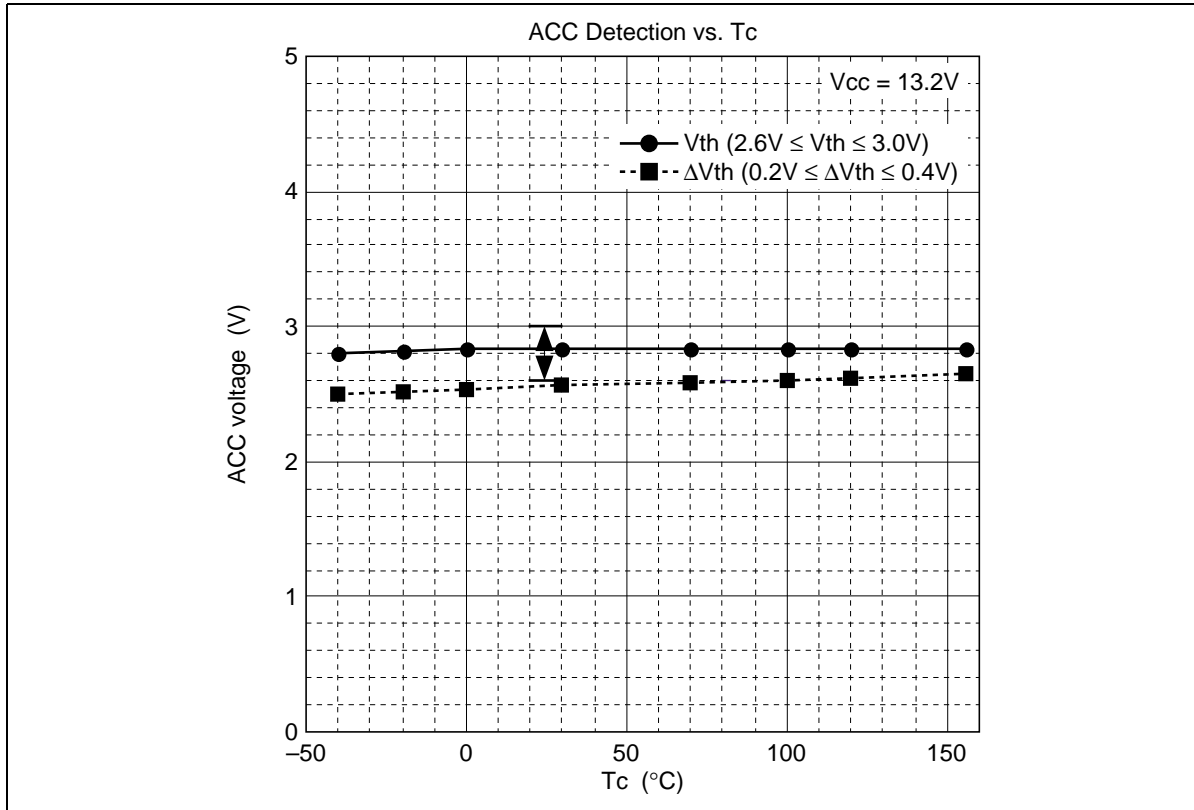

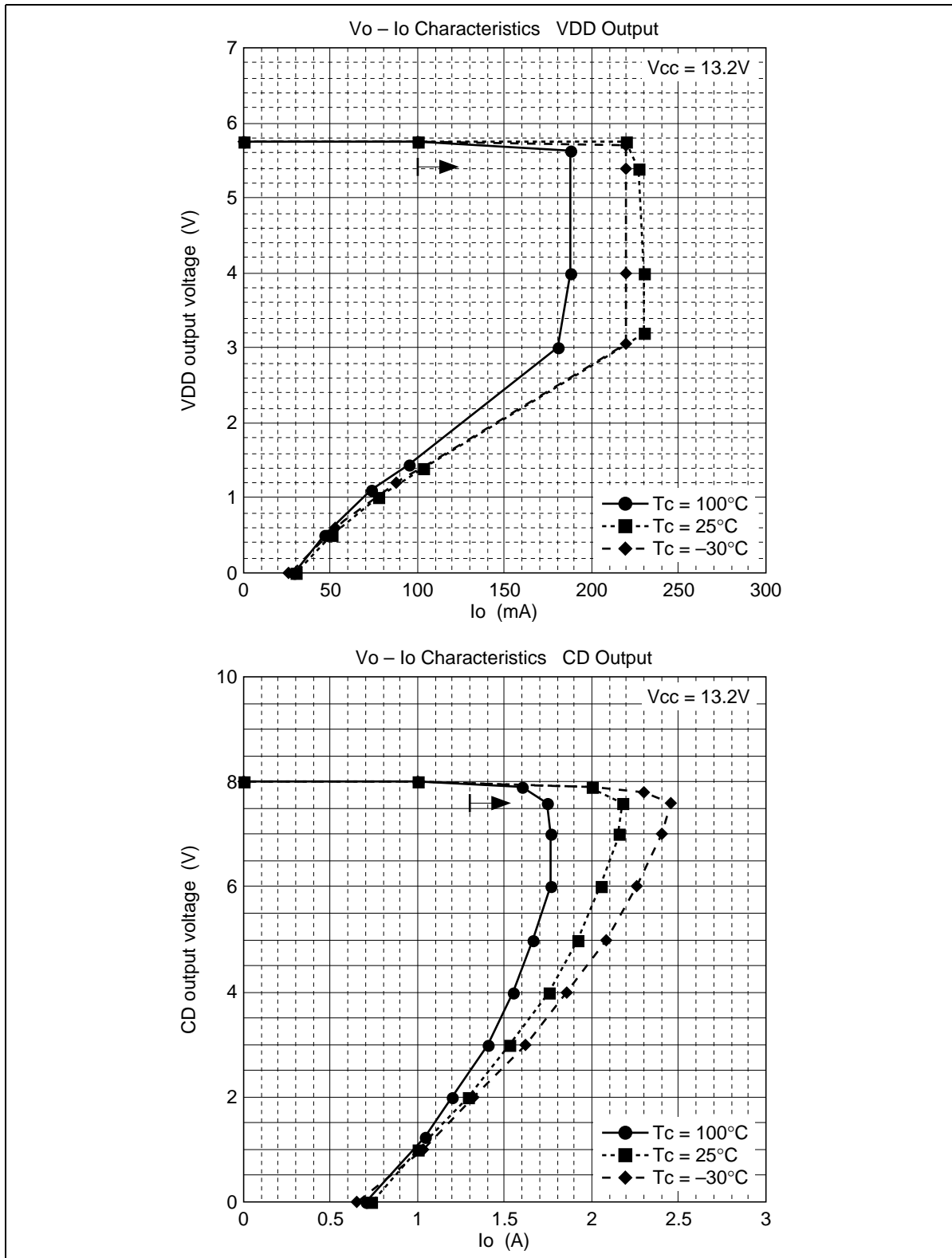

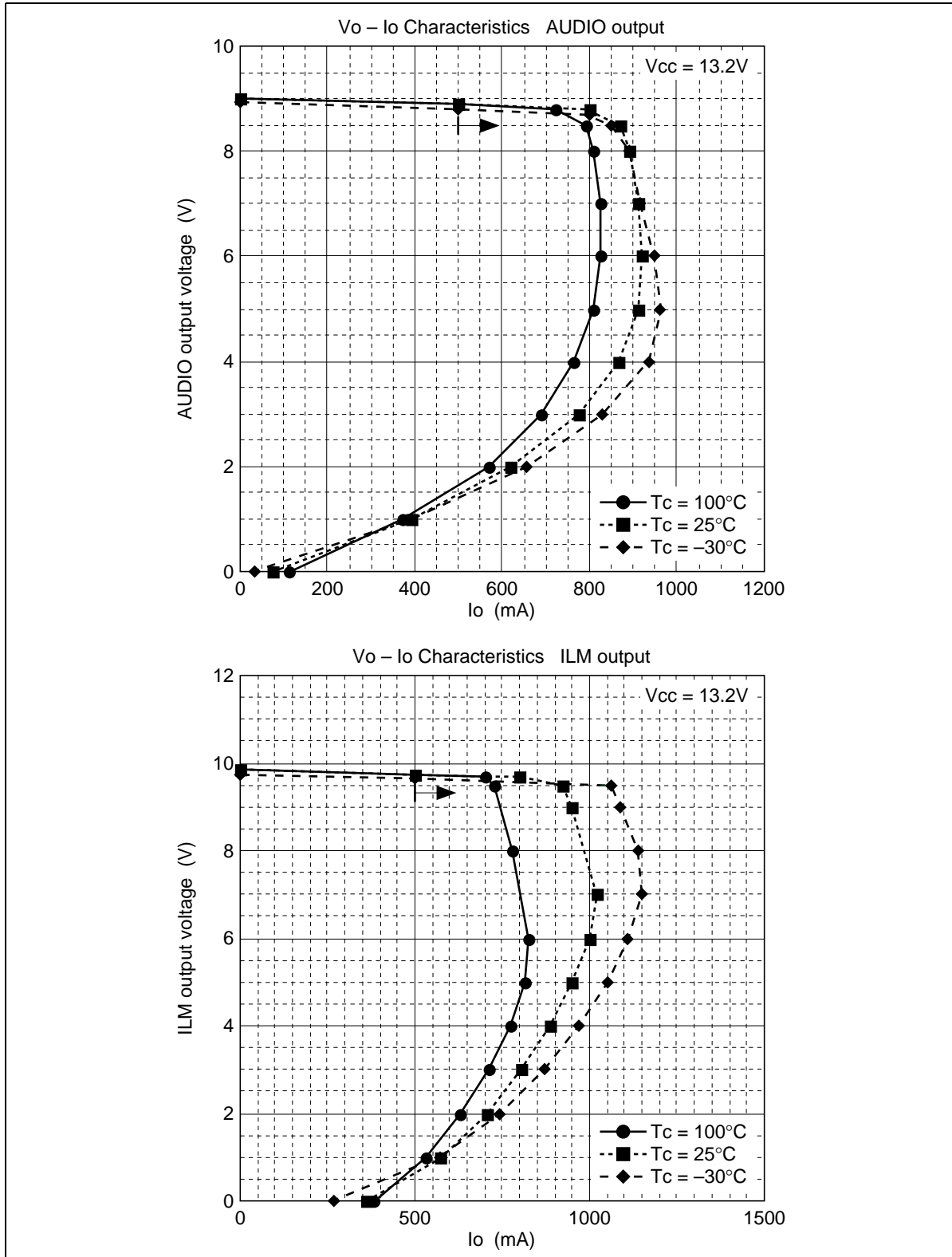

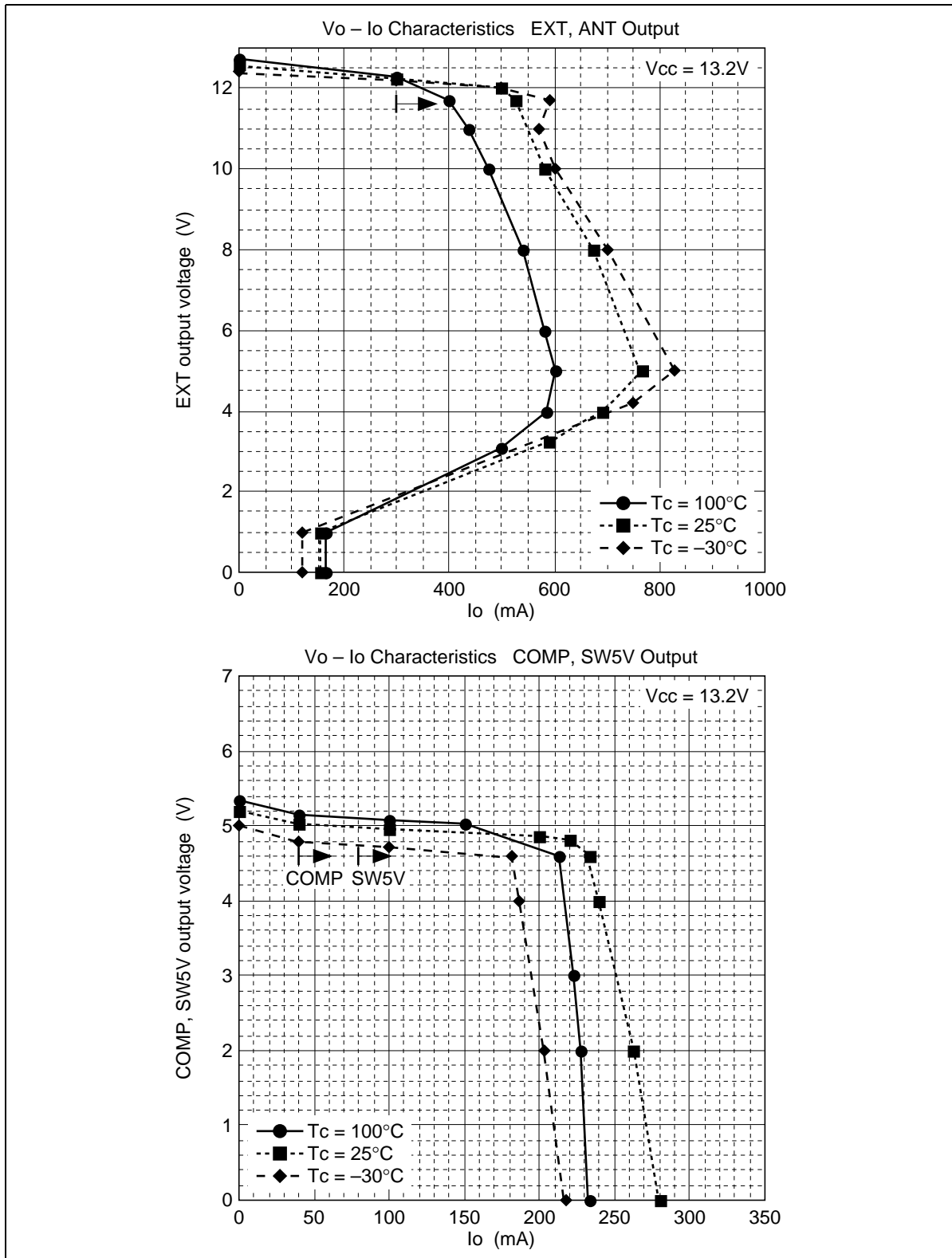

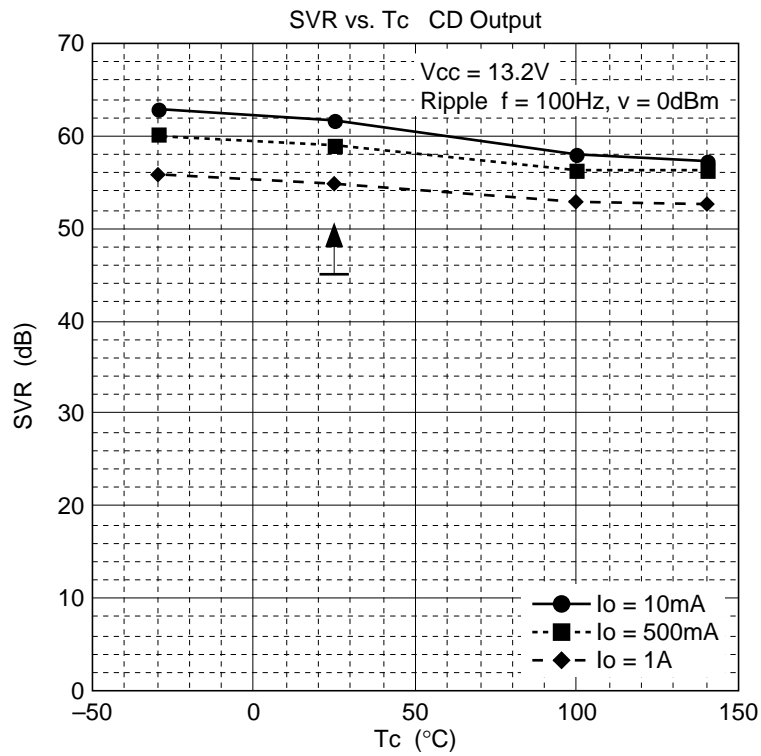
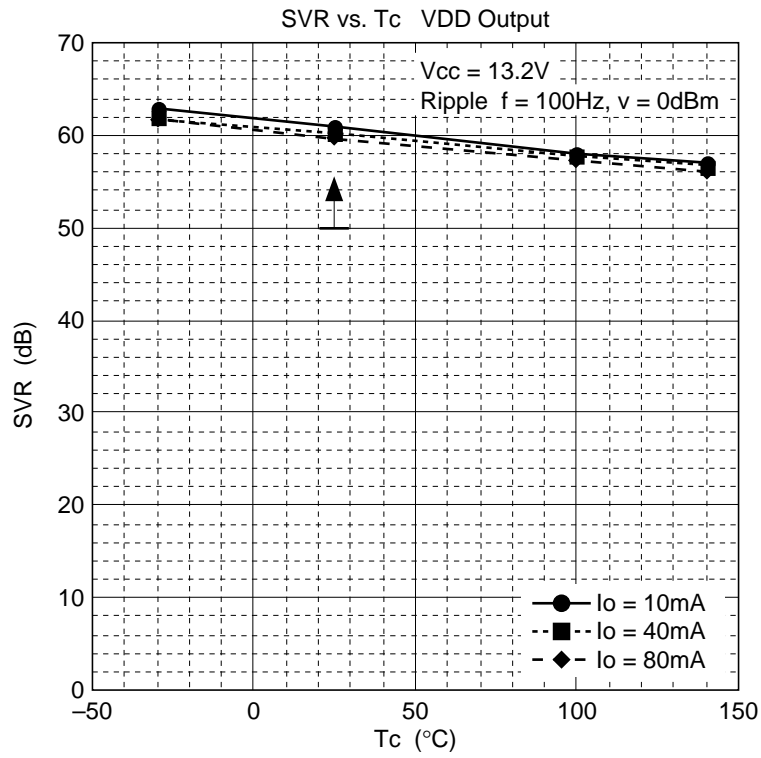

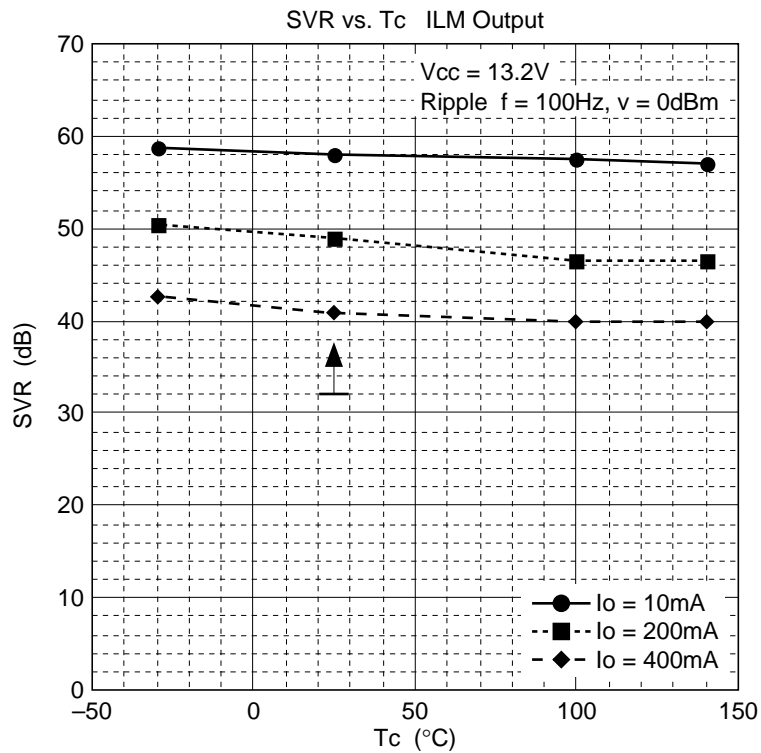
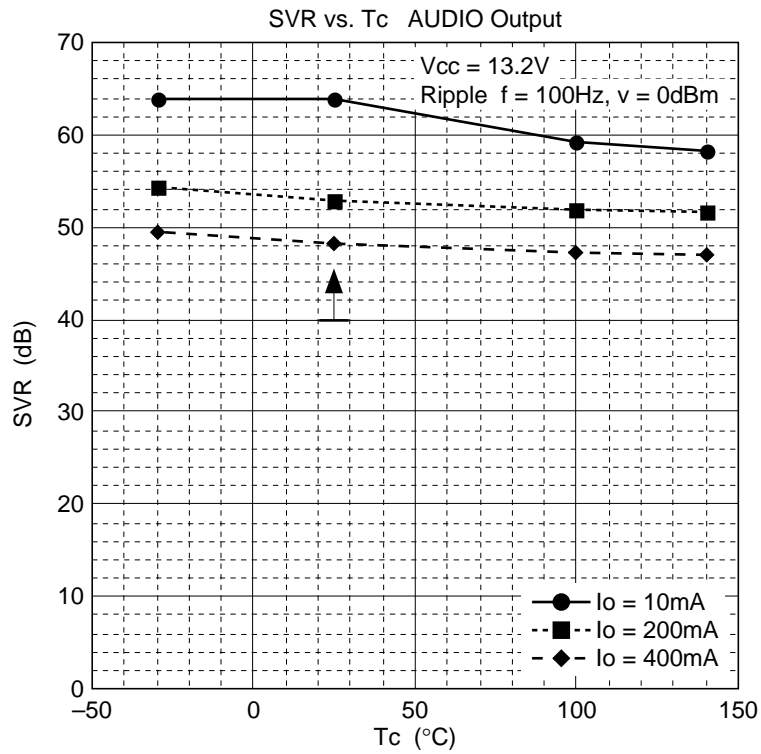

Package Dimensions

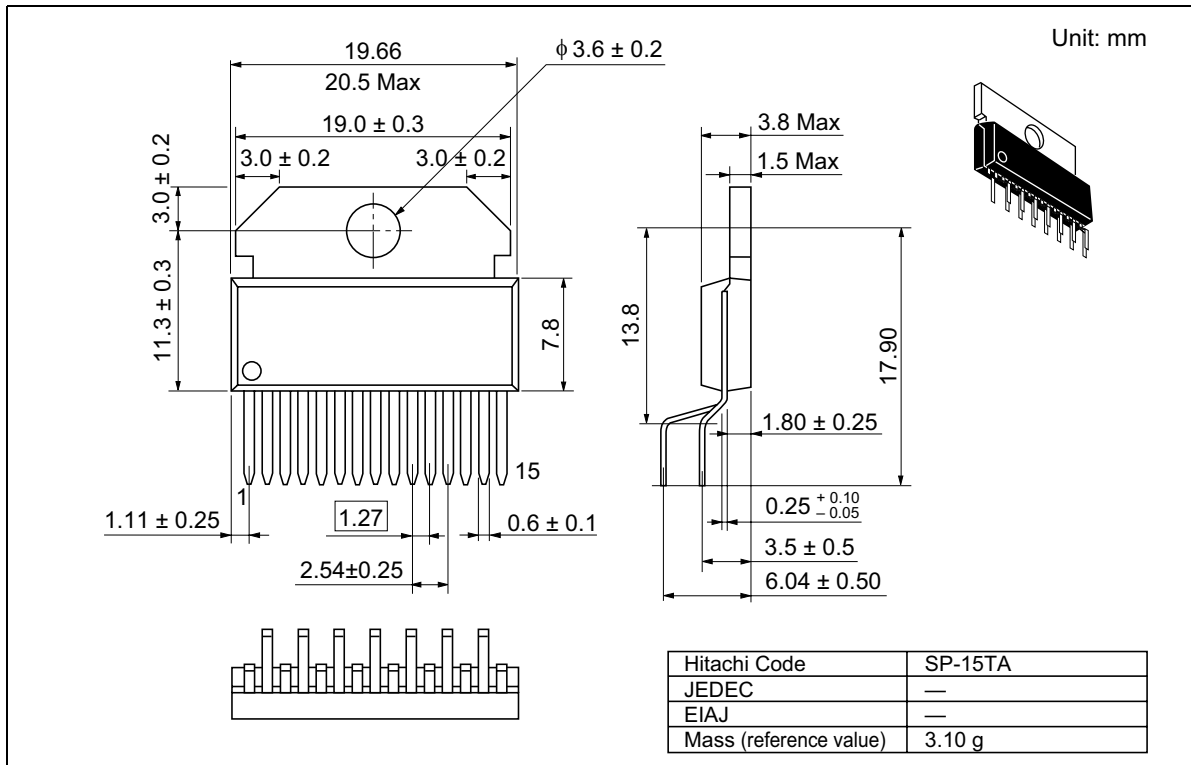

HA13164A

Disclaimer

1. Hitachi neither warrants nor grants licenses of any rights of Hitachi's or any third party's patent, copyright, trademark, or other intellectual property rights for information contained in this document. Hitachi bears no responsibility for problems that may arise with third party's rights, including intellectual property rights, in connection with use of the information contained in this document.
2. Products and product specifications may be subject to change without notice. Confirm that you have received the latest product standards or specifications before final design, purchase or use.
3. Hitachi makes every attempt to ensure that its products are of high quality and reliability. However, contact Hitachi's sales office before using the product in an application that demands especially high quality and reliability or where its failure or malfunction may directly threaten human life or cause risk of bodily injury, such as aerospace, aeronautics, nuclear power, combustion control, transportation, traffic, safety equipment or medical equipment for life support.
4. Design your application so that the product is used within the ranges guaranteed by Hitachi particularly for maximum rating, operating supply voltage range, heat radiation characteristics, installation conditions and other characteristics. Hitachi bears no responsibility for failure or damage when used beyond the guaranteed ranges. Even within the guaranteed ranges, consider normally foreseeable failure rates or failure modes in semiconductor devices and employ systemic measures such as fail-safes, so that the equipment incorporating Hitachi product does not cause bodily injury, fire or other consequential damage due to operation of the Hitachi product.
5. This product is not designed to be radiation resistant.
6. No one is permitted to reproduce or duplicate, in any form, the whole or part of this document without written approval from Hitachi.
7. Contact Hitachi's sales office for any questions regarding this document or Hitachi semiconductor products.

Sales Offices

HITACHI

Hitachi, Ltd.

Semiconductor & Integrated Circuits.

Nippon Bldg., 2-6-2, Ohte-machi, Chiyoda-ku, Tokyo 100-0004, Japan
Tel: Tokyo (03) 3270-2111 Fax: (03) 3270-5109

URL NorthAmerica : <http://semiconductor.hitachi.com/>
 Europe : <http://www.hitachi-eu.com/hel/ecg>
 Asia : <http://sicapac.hitachi-asia.com>
 Japan : <http://www.hitachi.co.jp/Sicd/indx.htm>

For further information write to:

Hitachi Semiconductor
(America) Inc.
179 East Tasman Drive,
San Jose, CA 95134
Tel: <1> (408) 433-1990
Fax: <1> (408) 433-0223

Hitachi Europe GmbH
Electronic Components Group
Dornacher Straße 3
D-85622 Feldkirchen, Munich
Germany
Tel: <49> (89) 9 9180-0
Fax: <49> (89) 9 29 30 00

Hitachi Europe Ltd.
Electronic Components Group.
Whitebrook Park
Lower Cookham Road
Maidenhead
Berkshire SL6 8YA, United Kingdom
Tel: <44> (1628) 585000
Fax: <44> (1628) 585160

Hitachi Asia Ltd.
Hitachi Tower
16 Collyer Quay #20-00,
Singapore 049318
Tel : <65>-538-6533/538-8577
Fax : <65>-538-6933/538-3877
URL : <http://www.hitachi.com.sg>

Hitachi Asia Ltd.
(Taipei Branch Office)
4/F, No. 167, Tun Hwa North Road,
Hung-Kuo Building,
Taipei (105), Taiwan
Tel : <886>-(2)-2718-3666
Fax : <886>-(2)-2718-8180
Telex : 23222 HAS-TP
URL : <http://www.hitachi.com.tw>

Hitachi Asia (Hong Kong) Ltd.
Group III (Electronic Components)
7/F., North Tower,
World Finance Centre,
Harbour City, Canton Road
Tsim Sha Tsui, Kowloon,
Hong Kong
Tel : <852>-(2)-735-9218
Fax : <852>-(2)-730-0281
URL : <http://www.hitachi.com.hk>

Copyright © Hitachi, Ltd., 2000. All rights reserved. Printed in Japan.
Colophon 2.0