

HD74AC153

Dual 4-Input Multiplexer

HITACHI

Description

The HD74AC153 is a high-speed dual 4-input multiplexer with common select inputs and individual enable inputs for each section. It can select two lines of data from four sources. The two buffered outputs present data in the true (noninverted) form. In addition to multiplexer operation, the HD74AC153 can act as a function generator and generate any two functions of three variables.

Feature

- Outputs Source/Sink 24 mA

Pin Arrangement

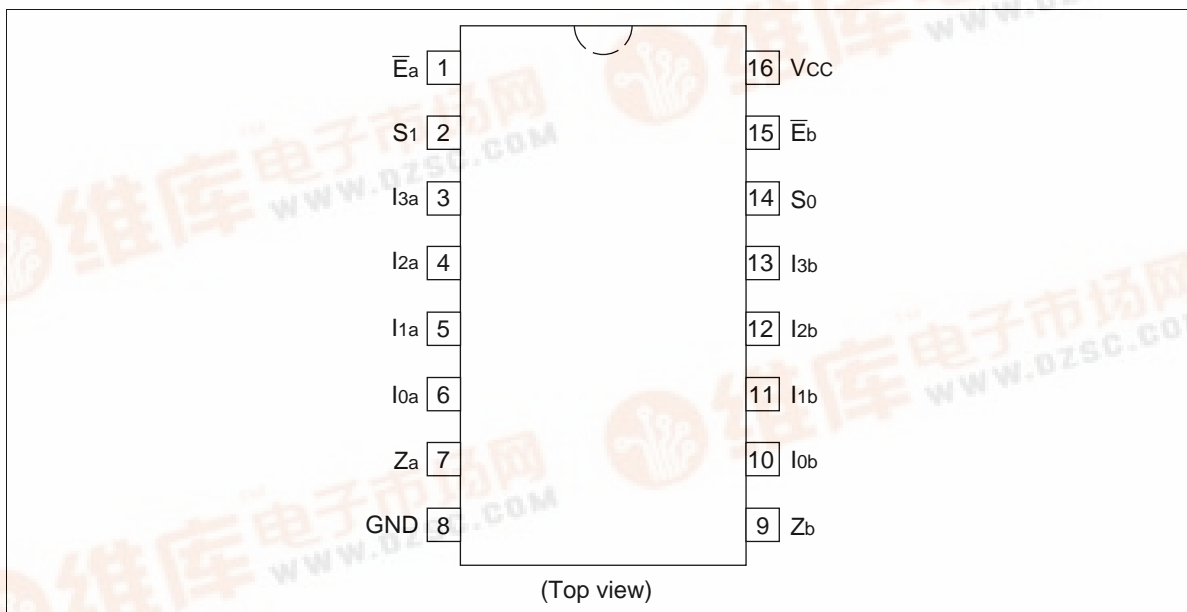

HD74AC153

Logic Symbol

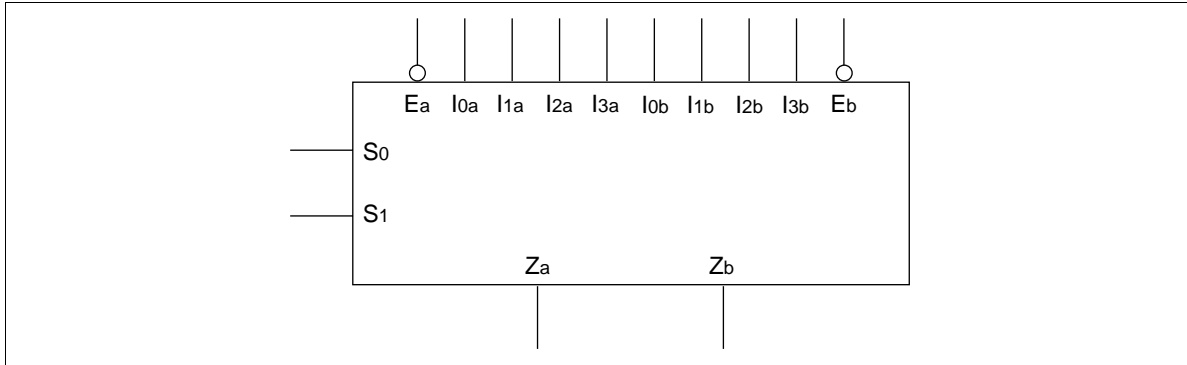

Pin Names

- I_{0a} to I_{3a} Side A Data Inputs
- I_{0b} to I_{3b} Side B Data Inputs
- S_0, S_1 Common Select Inputs
- \bar{E}_a Side A Enable Input
- \bar{E}_b Side B Enable Input
- Z_a Side A Output
- Z_b Side B Output

Functional Description

The HD74AC153 is a dual 4-input multiplexer. It can select two bits of data from up to four sources under the control of the common Select inputs (S_0, S_1). The two 4-input multiplexer circuits have individual active-Low Enables (\bar{E}_a, \bar{E}_b) which can be used to strobe the outputs independently. When the Enables (\bar{E}_a, \bar{E}_b) are High, the corresponding outputs (Z_a, Z_b) are forced Low. The HD74AC153 is the logic implementation of a 2-pole, 4-position switch, where the position of the switch is determined by the logic levels supplied to the two Select inputs. The logic equations for the outputs are shown below.

$$Z_a = \bar{E}_a \cdot (I_{0a} \cdot \bar{S}_1 \cdot \bar{S}_0 + I_{1a} \cdot \bar{S}_1 \cdot S_0 + I_{2a} \cdot S_1 \cdot \bar{S}_0 + I_{3a} \cdot S_1 \cdot S_0)$$
$$Z_b = \bar{E}_b \cdot (I_{0b} \cdot \bar{S}_1 \cdot \bar{S}_0 + I_{1b} \cdot \bar{S}_1 \cdot S_0 + I_{2b} \cdot S_1 \cdot \bar{S}_0 + I_{3b} \cdot S_1 \cdot S_0)$$

Truth Table

Select Inputs		Input (a or b)					Output
S_0	S_1	\bar{E}	I_0	I_1	I_2	I_3	Z
X	X	H	X	X	X	X	L
L	L	L	L	X	X	X	L
L	L	L	H	X	X	X	H
H	L	L	X	L	X	X	L
H	L	L	X	H	X	X	H
L	H	L	X	X	L	X	L
L	H	L	X	X	H	X	H
H	H	L	X	X	X	L	L
H	H	L	X	X	X	H	H

H : High Voltage Level

L : Low Voltage Level

X : Immaterial

HD74AC153

Logic Diagram

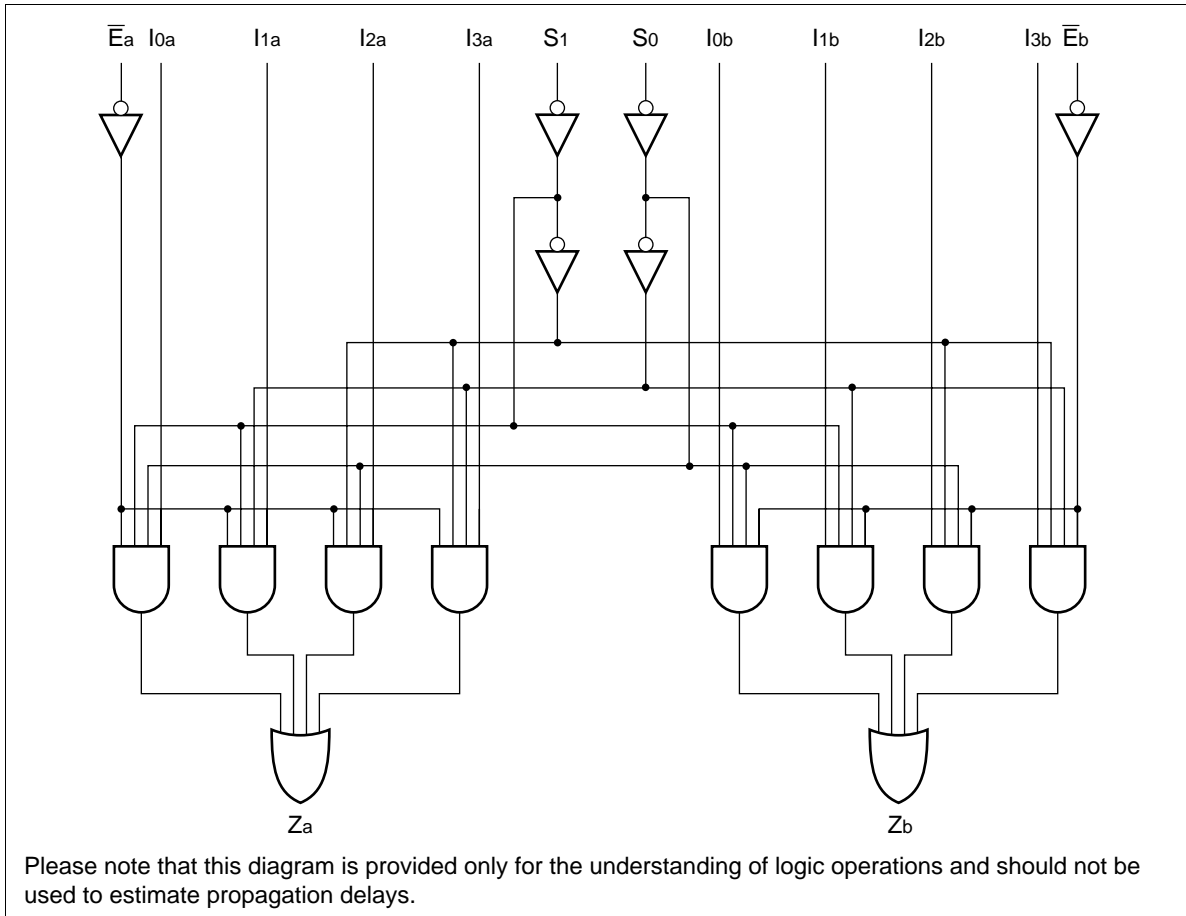

DC Characteristics (unless otherwise specified)

Item	Symbol	Max	Unit	Condition
Maximum quiescent supply current	I_{CC}	80	μA	$V_{IN} = V_{CC}$ or ground, $V_{CC} = 5.5 V$, $T_a = \text{Worst case}$
Maximum quiescent supply current	I_{CC}	8.0	μA	$V_{IN} = V_{CC}$ or ground, $V_{CC} = 5.5 V$, $T_a = 25^\circ C$

AC Characteristics: HD74AC153

Item	Symbol	V _{CC} (V)* ¹	Ta = +25°C C _L = 50 pF			Ta = -40°C to +85°C C _L = 50 pF		Unit
			Min	Typ	Max	Min	Max	
Propagation delay S _n to Z _n	t _{PLH}	3.3	1.0	9.5	15.0	1.0	17.5	ns
		5.0	1.0	6.5	11.0	1.0	12.5	
Propagation delay S _n to Z _n	t _{PHL}	3.3	1.0	8.5	14.5	1.0	16.5	ns
		5.0	1.0	6.5	11.0	1.0	12.0	
Propagation delay E _n to Z _n	t _{PLH}	3.3	1.0	8.0	13.5	1.0	16.0	ns
		5.0	1.0	5.5	9.5	1.0	11.0	
Propagation delay E _n to Z _n	t _{PHL}	3.3	1.0	7.0	11.0	1.0	12.5	ns
		5.0	1.0	5.0	8.0	1.0	9.0	
Propagation delay I _n to Z _n	t _{PLH}	3.3	1.0	7.5	12.5	1.0	14.5	ns
		5.0	1.0	5.5	9.0	1.0	10.5	
Propagation delay I _n to Z _n	t _{PHL}	3.3	1.0	7.0	11.5	1.0	13.0	ns
		5.0	1.0	5.0	8.5	1.0	10.0	

Note: 1. Voltage Range 3.3 is 3.3 V ± 0.3 V
Voltage Range 5.0 is 5.0 V ± 0.5 V

Capacitance

Item	Symbol	Typ	Unit	Condition
Input capacitance	C _{IN}	4.5	pF	V _{CC} = 5.5 V
Power dissipation capacitance	C _{PD}	65.0	pF	V _{CC} = 5.0 V

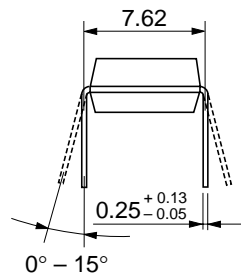
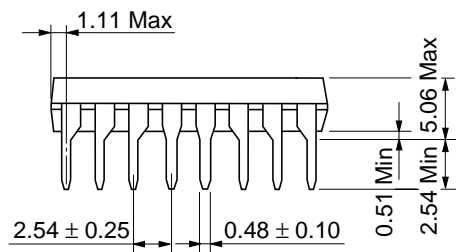
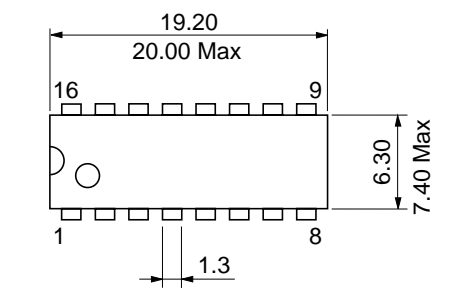

Unit: mm

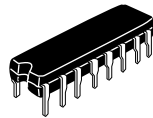

Unit: mm

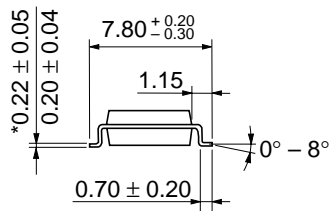
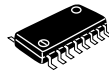
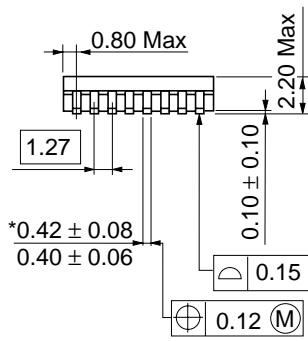
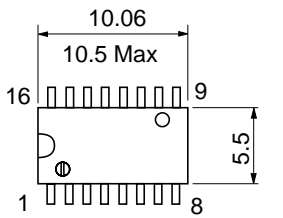

Unit: mm

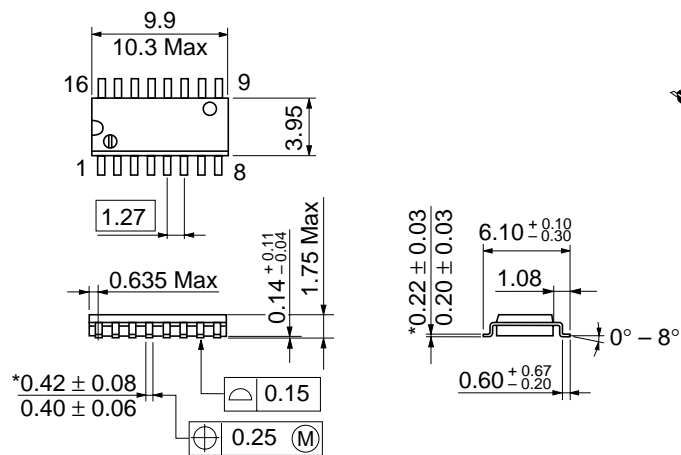

Unit: mm

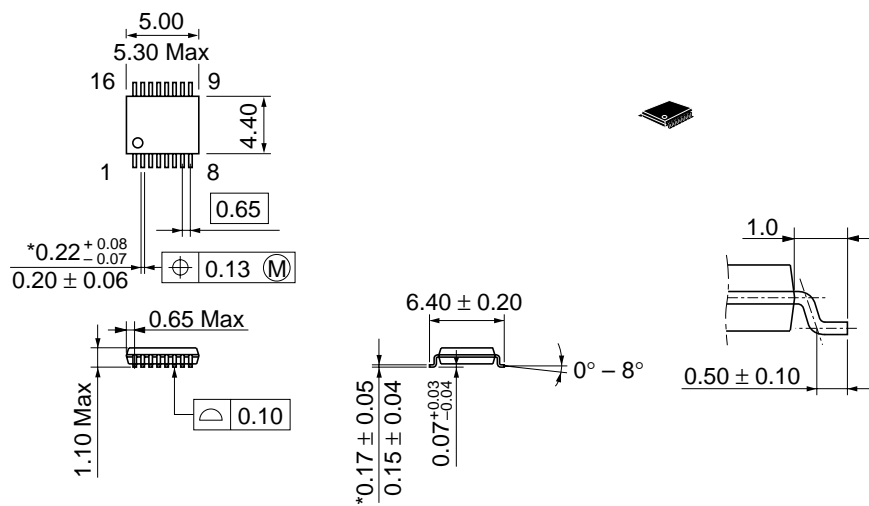

Cautions

1. Hitachi neither warrants nor grants licenses of any rights of Hitachi's or any third party's patent, copyright, trademark, or other intellectual property rights for information contained in this document. Hitachi bears no responsibility for problems that may arise with third party's rights, including intellectual property rights, in connection with use of the information contained in this document.
2. Products and product specifications may be subject to change without notice. Confirm that you have received the latest product standards or specifications before final design, purchase or use.
3. Hitachi makes every attempt to ensure that its products are of high quality and reliability. However, contact Hitachi's sales office before using the product in an application that demands especially high quality and reliability or where its failure or malfunction may directly threaten human life or cause risk of bodily injury, such as aerospace, aeronautics, nuclear power, combustion control, transportation, traffic, safety equipment or medical equipment for life support.
4. Design your application so that the product is used within the ranges guaranteed by Hitachi particularly for maximum rating, operating supply voltage range, heat radiation characteristics, installation conditions and other characteristics. Hitachi bears no responsibility for failure or damage when used beyond the guaranteed ranges. Even within the guaranteed ranges, consider normally foreseeable failure rates or failure modes in semiconductor devices and employ systemic measures such as fail-safes, so that the equipment incorporating Hitachi product does not cause bodily injury, fire or other consequential damage due to operation of the Hitachi product.
5. This product is not designed to be radiation resistant.
6. No one is permitted to reproduce or duplicate, in any form, the whole or part of this document without written approval from Hitachi.
7. Contact Hitachi's sales office for any questions regarding this document or Hitachi semiconductor products.

HITACHI

Hitachi, Ltd.

Semiconductor & Integrated Circuits.
Nippon Bldg., 2-6-2, Ohte-machi, Chiyoda-ku, Tokyo 100-0004, Japan
Tel: Tokyo (03) 3270-2111 Fax: (03) 3270-5109

URL NorthAmerica : <http://semiconductor.hitachi.com/>
 Europe : <http://www.hitachi-eu.com/hel/ecg>
 Asia (Singapore) : <http://www.has.hitachi.com.sg/grp3/sicd/index.htm>
 Asia (Taiwan) : http://www.hitachi.com.tw/E/Product/SICD_Frame.htm
 Asia (HongKong) : <http://www.hitachi.com.hk/eng/bo/grp3/index.htm>
 Japan : <http://www.hitachi.co.jp/Sicd/indx.htm>

For further information write to:

Hitachi Semiconductor
(America) Inc.
179 East Tasman Drive,
San Jose, CA 95134
Tel: <1> (408) 433-1990
Fax: <1> (408) 433-0223

Hitachi Europe GmbH
Electronic components Group
Dornacher StraÙe 3
D-85622 Feldkirchen, Munich
Germany
Tel: <49> (89) 9 9180-0
Fax: <49> (89) 9 29 30 00

Hitachi Europe Ltd.
Electronic Components Group.
Whitebrook Park
Lower Cookham Road
Maidenhead
Berkshire SL6 8YA, United Kingdom
Tel: <44> (1628) 585000
Fax: <44> (1628) 778322

Hitachi Asia Pte. Ltd.
16 Collyer Quay #20-00
Hitachi Tower
Singapore 049318
Tel: 535-2100
Fax: 535-1533

Hitachi Asia Ltd.
Taipei Branch Office
3F, Hung Kuo Building, No.167,
Tun-Hwa North Road, Taipei (105)
Tel: <886> (2) 2718-3666
Fax: <886> (2) 2718-8180

Hitachi Asia (Hong Kong) Ltd.
Group III (Electronic Components)
7/F., North Tower, World Finance Centre,
Harbour City, Canton Road, Tsim Sha Tsui,
Kowloon, Hong Kong
Tel: <852> (2) 735 9218
Fax: <852> (2) 730 0281
Telex: 40815 HITEC HX