



### 1.7GHz - 2.3GHz Low Noise Amplifier



The Intersil HFA3421 PRISM® is a high performance low noise amplifier in a low cost SOIC 8 lead surface mount plastic package. The HFA3421 employs a fully monolithic design which

eliminates the need for external tuning networks. It can be biased using 3V or 5V supplies and has an option for biasing at higher currents for increased dynamic range.

The HFA3421 is ideally suited for use where low noise figure, high gain, high dynamic range and low power consumption are required. Typical applications include receiver front ends in the Wireless Local Loop (WLL) systems, as well as standard gain blocks, buffer amps, driver amps and IF amps in both fixed and portable systems.

### Ordering Information

PART NUMBER	TEMP. RANGE (°C)	PACKAGE	PKG. NO.
HFA3421IB	-40 to 85	8 Ld SOIC	M8.15
HFA3421IB96	-40 to 85	Tape and Reel	

### Pinout

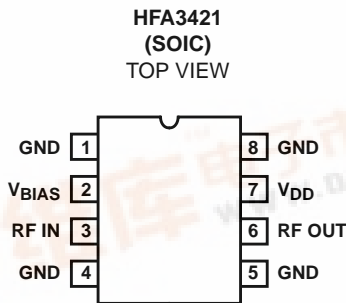

### Features

- Low Noise Figure ..... 1.65dB
- High Gain ..... .20dB
- Low Power Consumption ..... 3V to 5V, 8mA
- High Dynamic Range
- DC Decoupled RF Input and Output
- No External RF Tuning Elements Necessary
- Low Cost SOIC 8 Lead Plastic Package

### Applications

- Wireless Local Loop
- TDD Quadrature-Modulated Communication Systems
- Wireless Local Area Networks
- PCMCIA Wireless Transceivers
- TDMA Packet Protocol Radio
- PCS/Wireless PBX

### Functional Block Diagram

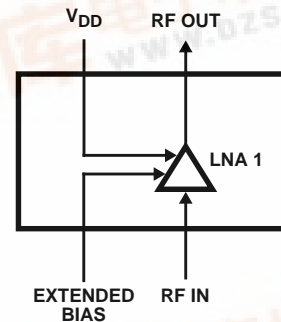

# HFA3421

## Absolute Maximum Ratings

Supply Voltage,  $V_{DD}$  ..... +10V<sub>DC</sub>  
 Input Power ..... +17dBm  
 Supply Current (Note 1) ..... 30mA

## Thermal Information

Thermal Resistance (Typical, Note 2) .....  $\theta_{JA}$  (°C/W)  
 SOIC Package ..... 165  
 Maximum Storage Temperature Range ..... -65°C to 150°C  
 Maximum Lead Temperature (Solder 10s) ..... 300°C  
 (SOIC - Lead Tips Only)

## Operating Conditions

Temperature Range ..... -40°C to 85°C

*CAUTION: Stresses above those listed in "Absolute Maximum Ratings" may cause permanent damage to the device. This is a stress only rating and operation of the device at these or any other conditions above those indicated in the operational sections of this specification is not implied.*

### NOTES:

1. Only if pin #2 is used to increase current.
2.  $\theta_{JA}$  is measured with the component mounted on an evaluation PC board in free air.

## Electrical Specifications $T_A = 25^\circ\text{C}$ , $Z_0 = 50\Omega$ , $V_{DD} = +5\text{V}$ , $P_{IN} = -30\text{dBm}$ , $f = 1.7\text{-}2.3\text{GHz}$ , $V_{BIAS} = \text{Open Circuit}$ Unless Otherwise Specified

PARAMETER	MIN	TYP	MAX	UNITS
LNA Input Frequency Range	1.7	-	2.3	GHz
Gain	14	20		dB
Noise Figure	-	1.65	2.30	dB
Input VSWR	-	1.5:1	-	
Output VSWR	-	1.5:1	-	
Input Return Loss	-	-14.0	-	dB
Output Return Loss	-	-14.0	-	dB
Output 1dB Compression	-	7	-	dBm
Input IP <sub>3</sub>	-	-1	-	dBm
Reverse Isolation	-	30	-	dB
Supply Current at $V_{CC} = 5\text{V}$	-	8	-	mA
Supply Range	2.7	-	5.5	V
$V_{BIAS}$ Voltage	TBD	TBD	TBD	V
$V_{BIAS}$ Current	TBD	TBD	TBD	mA

## Typical Performance Curves

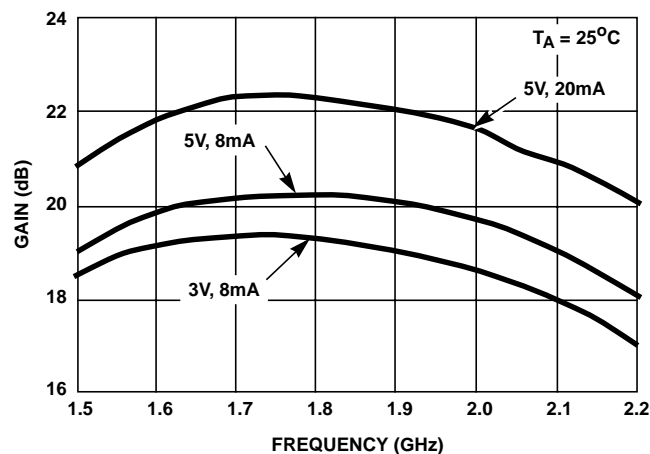

FIGURE 1. GAIN vs FREQUENCY

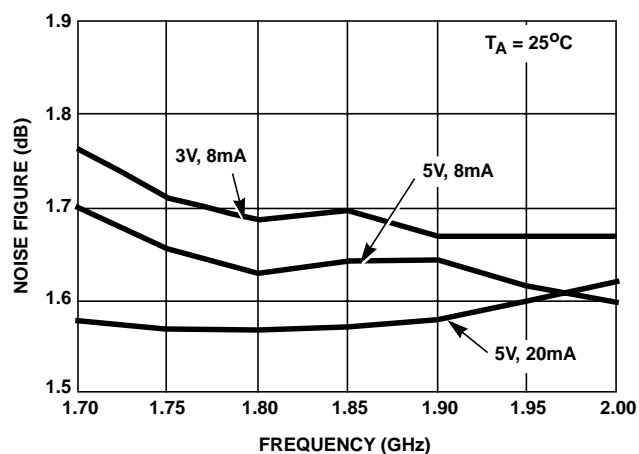

FIGURE 2. NOISE FIGURE vs FREQUENCY

Typical Performance Curves (Continued)

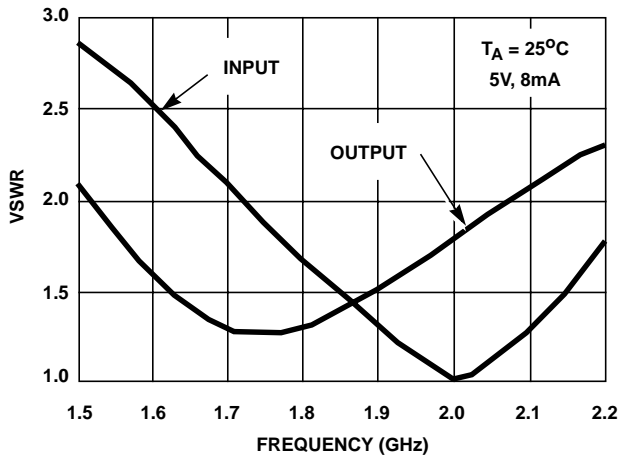

FIGURE 3. VSWR vs FREQUENCY

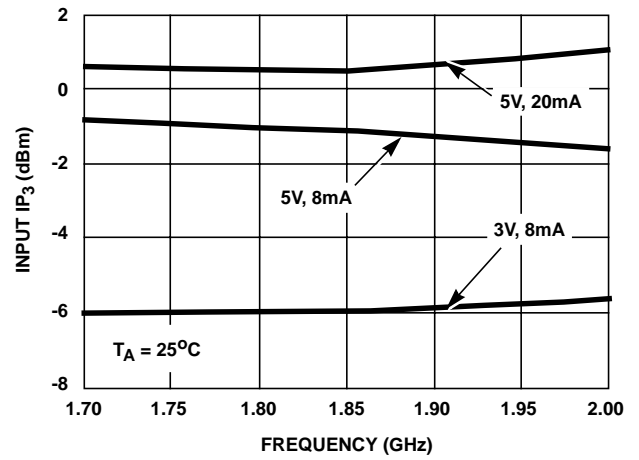

FIGURE 4. INPUT IP<sub>3</sub> vs FREQUENCY

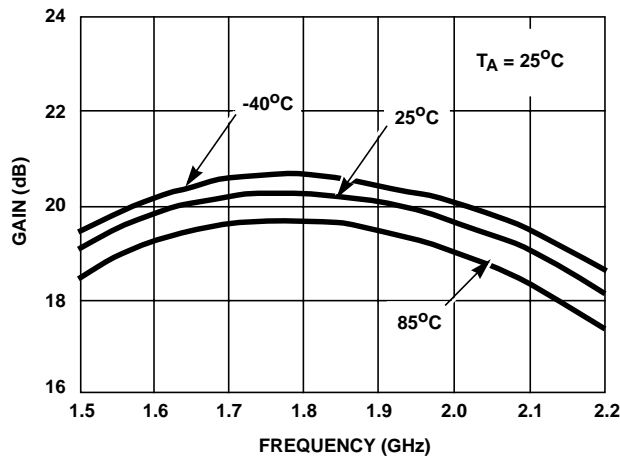

FIGURE 5. GAIN vs FREQUENCY

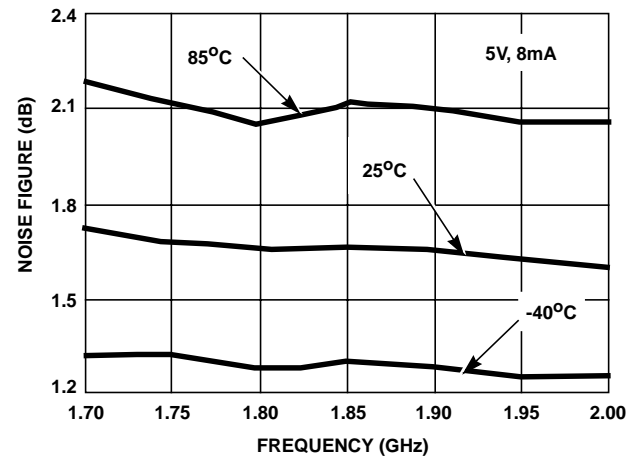

FIGURE 6. NOISE FIGURE vs FREQUENCY

Typical Application Circuit

V <sub>BIAS</sub> (PIN 2)	
NORMAL BIAS	EXTENDED BIAS
Open	30Ω to 35Ω to Ground

PIN 2 ALLOWS FOR AN EXTERNAL RESISTOR R<sub>BB</sub> TO BE USED TO GROUND FOR AN OPTIONAL 20mA CURRENT OPERATION. RECOMMENDED VALUES FOR THE CHIP RESISTOR ARE 30Ω TO 35Ω.

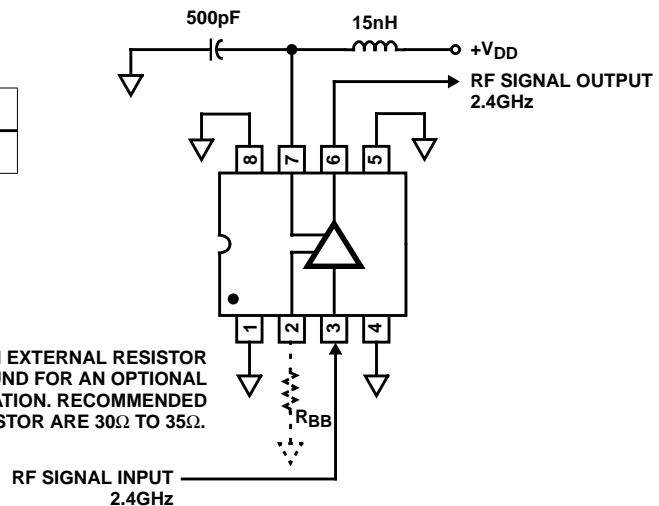

FIGURE 7. REFERENCE APPLICATION/TEST DESIGN SETUP SCHEMATIC: LOW NOISE AMPLIFIER