

International IR Rectifier FRED

PD - 94326

HFB35HB20C

Ultrafast, Soft Recovery Diode

Features

- Reduced RFI and EMI
- Reduced Snubbing
- Extensive Characterization of Recovery Parameters
- Hermetic

$$V_R = 200V$$

$$I_{F(AV)} = 35A$$

$$t_{rr} = 35ns$$

Description

These Ultrafast, soft recovery diodes are optimized to reduce losses and EMI/RFI in high frequency power conditioning systems. An extensive characterization of the recovery behavior for different values of current, temperature and di/dt simplifies the calculations of losses in the operating conditions. The softness of the recovery eliminates the need for a snubber in most applications. These devices are ideally suited for power converters, motors drives and other applications where switching losses are significant portion of the total losses.

Absolute Maximum Ratings

	Parameter	Max.	Units
V_R	Cathode to Anode Voltage (Per Leg)	200	V
$I_{F(AV)}$	Continuous Forward Current, ① $T_C = 108^\circ C$	35	A
I_{FSM}	Single Pulse Forward Current, ② $T_C = 25^\circ C$ (Per Leg)	150	
$P_D @ T_C = 25^\circ C$	Maximum Power Dissipation	90	W
T_J, T_{STG}	Operating Junction and Storage Temperature Range	-55 to +150	$^\circ C$

Note: ① D.C. = 50% rect. wave
 ② 1/2 sine wave, 60 Hz , P.W. = 8.33 ms

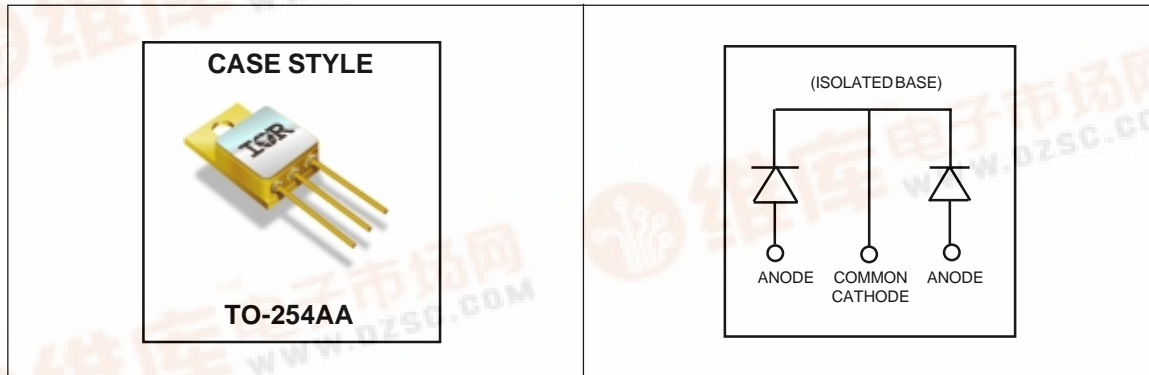

Electrical Characteristics (Per Leg) @ $T_J = 25^\circ\text{C}$ (unless otherwise specified)

	Parameter	Min.	Typ.	Max.	Units	Test Conditions
V_{BR}	Cathode Anode Breakdown Voltage	200	—	—	V	$I_R = 100\mu\text{A}$
V_F	Forward Voltage See Fig. 1	—	—	1.3	V	$I_F = 17.5\text{A}, T_J = -55^\circ\text{C}$
		—	—	1.1		$I_F = 17.5\text{A}, T_J = 25^\circ\text{C}$
		—	—	1.4		$I_F = 35\text{A}, T_J = 25^\circ\text{C}$
		—	—	1.0		$I_F = 17.5\text{A}, T_J = 125^\circ\text{C}$
I_R	Reverse Leakage Current See Fig. 2	—	—	0.1	μA	$V_R = V_R \text{ Rated}$
		—	—	50	μA	$V_R = V_R \text{ Rated}, T_J = 125^\circ\text{C}$
C_T	Junction Capacitance, See Fig. 3	—	—	150	pF	$V_R = 200\text{V}$
L_S	Series Inductance	—	6.7	—	nH	Measured from anode lead to cathode lead, 6mm (0.025 in) from package

Dynamic Recovery Characteristics (Per Leg) @ $T_J = 25^\circ\text{C}$ (unless otherwise specified)

	Parameter	Min.	Typ.	Max.	Units	Test Conditions
t_{rr}	Reverse Recovery Time	—	—	35	ns	$I_F = 1.0\text{A}, V_R = 30\text{V}, di/dt = 200\text{A}/\mu\text{s}$
t_{rr1}	Reverse Recovery Time	—	28	—	ns	$T_J = 25^\circ\text{C}$ See Fig. 5
t_{rr2}		—	46	—		$T_J = 125^\circ\text{C}$
I_{RRM1}	Peak Recovery Current	—	4.0	—	A	$T_J = 25^\circ\text{C}$ See Fig. 6
I_{RRM2}		—	12.3	—		$T_J = 125^\circ\text{C}$
Q_{rr1}	Reverse Recovery Charge	—	66	—	nC	$T_J = 25^\circ\text{C}$ See Fig. 7
Q_{rr2}		—	190	—		$T_J = 125^\circ\text{C}$
$di_{(rec)M}/dt1$	Peak Rate of Fall of Recovery Current During t_b	—	410	—	A/ μs	$T_J = 25^\circ\text{C}$ See Fig. 8
$di_{(rec)M}/dt2$		—	1740	—		$T_J = 125^\circ\text{C}$

Thermal - Mechanical Characteristics

	Parameter	Typ.	Max.	Units
R_{thJC}	Junction-to-Case, Single Leg Conducting	—	1.4	$^\circ\text{C}/\text{W}$
Wt	Weight	9.3	—	g

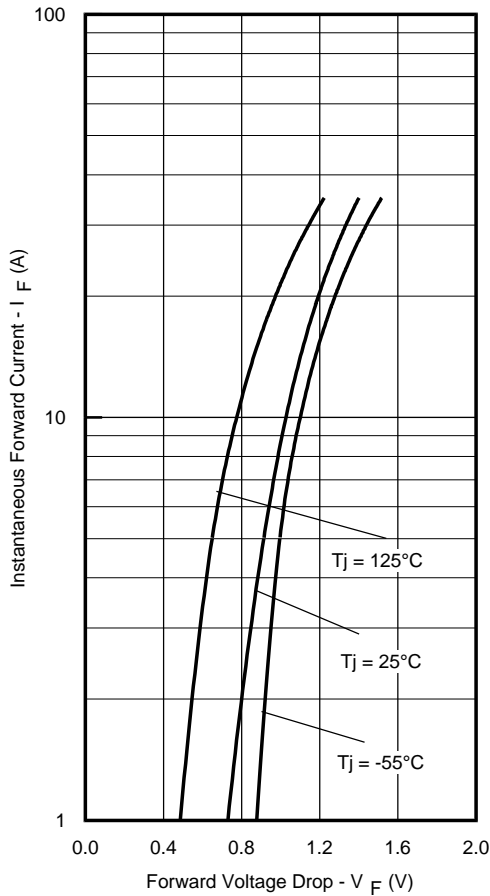

Fig. 1 - Maximum Forward Voltage Drop Vs. Instantaneous Forward Current (Per Leg)

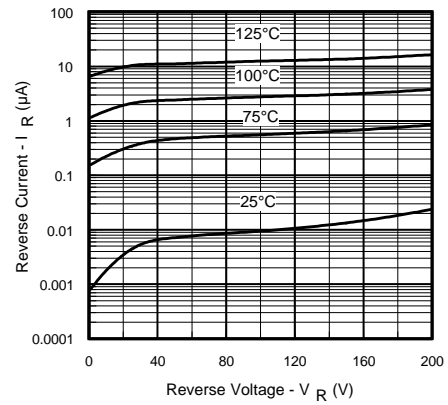

Fig. 2 - Typical Reverse Current Vs. Reverse Voltage (Per Leg)

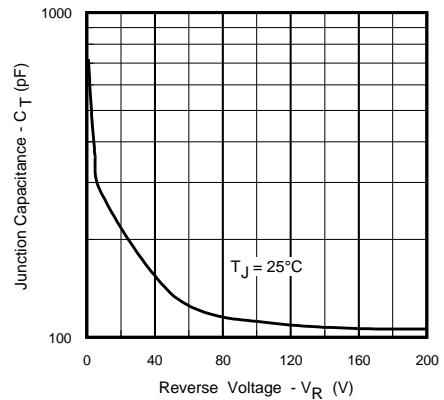

Fig. 3 - Typical Junction Capacitance Vs. Reverse Voltage (Per Leg)

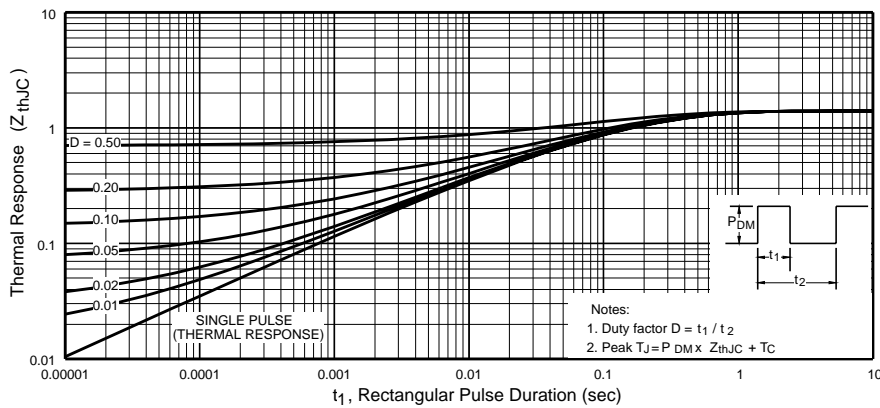

Fig. 4 - Maximum Thermal Impedance Z_{thJC} Characteristics (Per Leg)

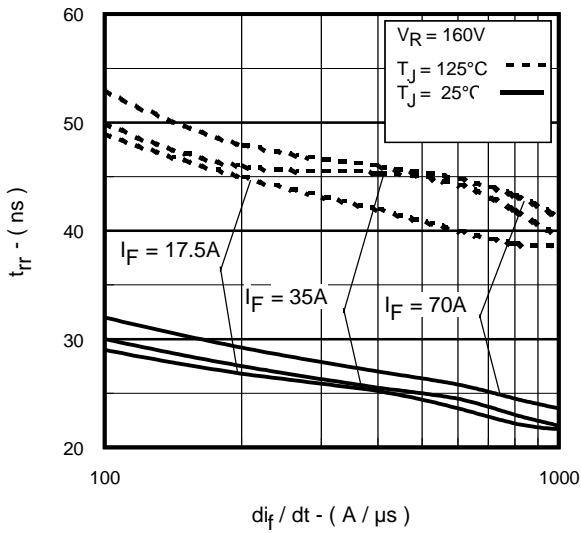

Fig. 5 - Typical Reverse Recovery Vs. di_f/dt (Per Leg)

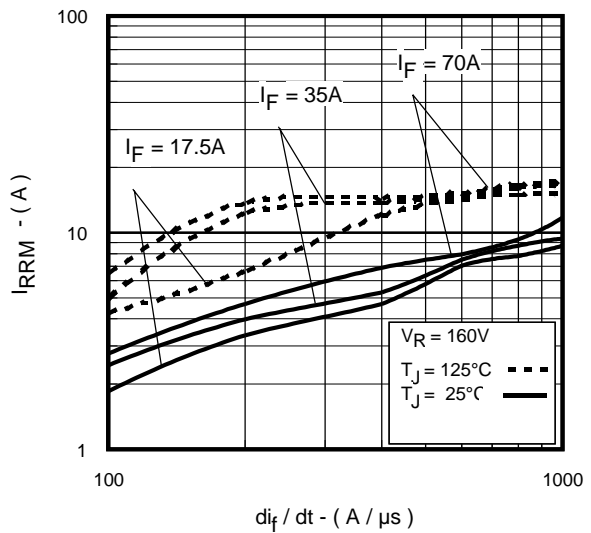

Fig. 6 - Typical Recovery Current Vs. di_f/dt (Per Leg)

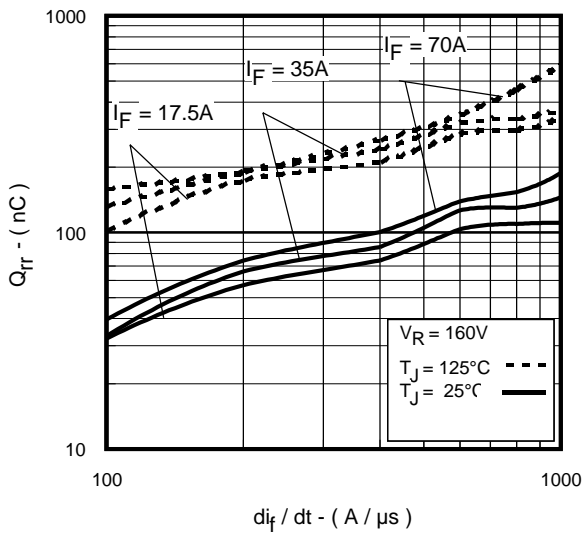

Fig. 7 - Typical Stored Charge Vs. di_f/dt (Per Leg)

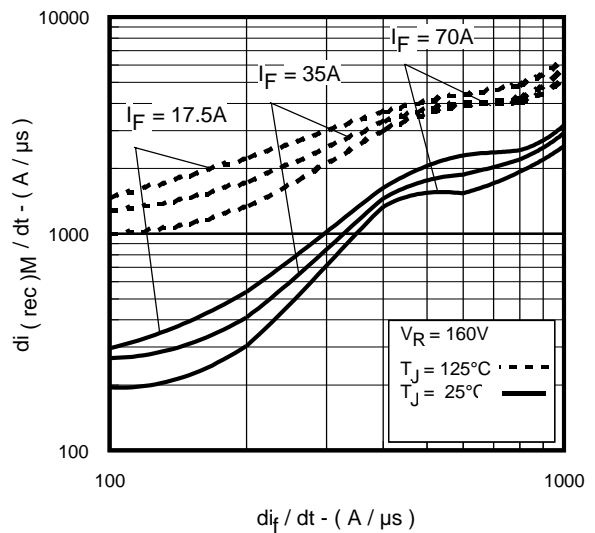

Fig. 8 - Typical $di_{(rec)M}/dt$ Vs. di_f/dt (Per Leg)

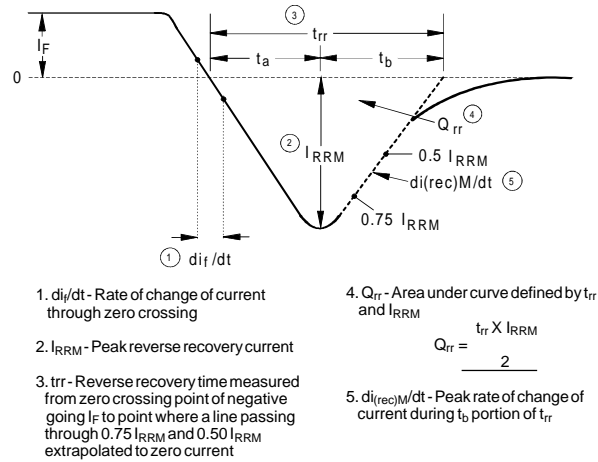
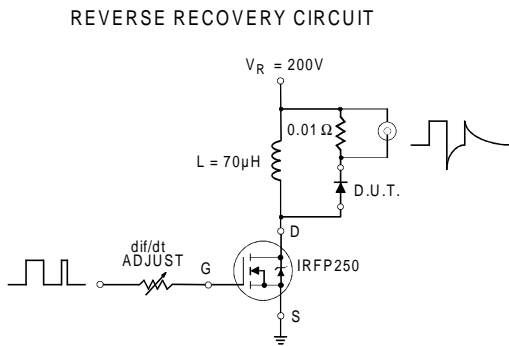
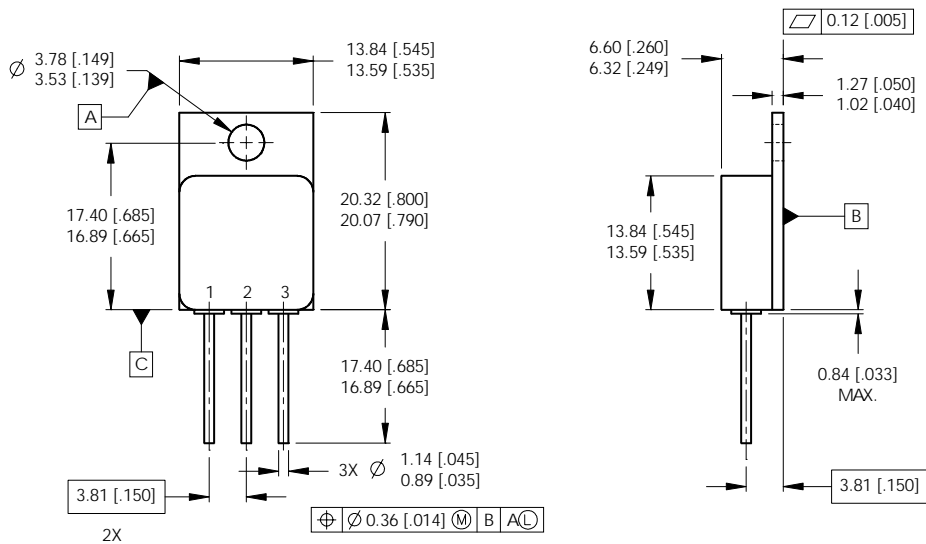

Fig. 9 - Reverse Recovery Parameter Test Circuit

Fig. 10 - Reverse Recovery Waveform and Definitions

Case Outline and Dimensions — TO-254AA



NOTES:

1. DIMENSIONING & TOLERANCING PER ASME Y14.5M-1994.
2. ALL DIMENSIONS ARE SHOWN IN MILLIMETERS [INCHES].
3. CONTROLLING DIMENSION: INCH.
4. CONFORMS TO JEDEC OUTLINE TO-254AA.

PIN ASSIGNMENTS

- 1 = ANODE 1
- 2 = COMMON CATHODE
- 3 = ANODE 2