



HMC121G8

GaAs MMIC SMT VOLTAGE-VARIABLE ATTENUATOR DC - 8 GHz

FEBRUARY 2001

Features

- WIDE BANDWIDTH: DC - 8 GHz
- LOW PHASE SHIFT VS. ATTENUATION
- 30 dB ATTENUATION RANGE
- SIMPLIFIED VOLTAGE CONTROL

General Description

The HMC121G8 is an absorptive voltage variable attenuator provided in a surface-mount hermetic package. It features an on-chip reference attenuator for use with an external op-amp to provide simple single voltage attenuation control. The device is ideal in designs where an analog control signal must control RF signal levels over a 30 dB amplitude range, such as in AGC circuits and in temperature compensation of multiple gain stages. Applications include military ECM and communications as well as commercial microwave radios and VSAT.

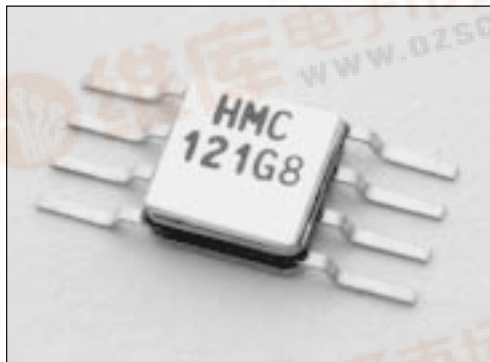

2 SMT ATTENUATORS

Guaranteed Performance, 50 ohm system, -55 to +85 deg C

Parameter		Min.	Typ.	Max.	Units
Insertion Loss	DC - 4 GHz:		1.5	3.0	dB
	DC - 8 GHz:		2	3.5	dB
Attenuation Range		25	30		dB
Return Loss	DC - 4 GHz:	10	15		dB
	DC - 8 GHz:	7	10		dB
Switching Characteristics	tRISE, tFALL (10/90% RF):		3		ns
	tON, tOFF (50% CTL to 10/90% RF):		6		ns
Input Power for 0.25dB Comp. (0.5 - 8GHz)	Min. Atten:		+10		dBm
	Atten. > 2dB:		-2		dBm
Input Third Order Intercept (two - 8 dBm signals)	Min. Atten:		+25		dBm
	Atten. > 2dB:		+10		dBm



HMC121G8 SMT VOLTAGE-VARIABLE ATTENUATOR DC - 8 GHz

FEBRUARY 2001

Insertion Loss

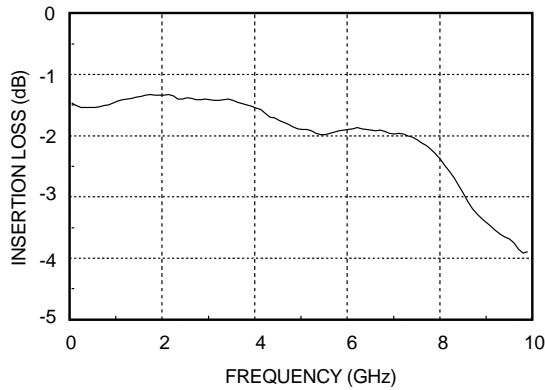

Relative Attenuation

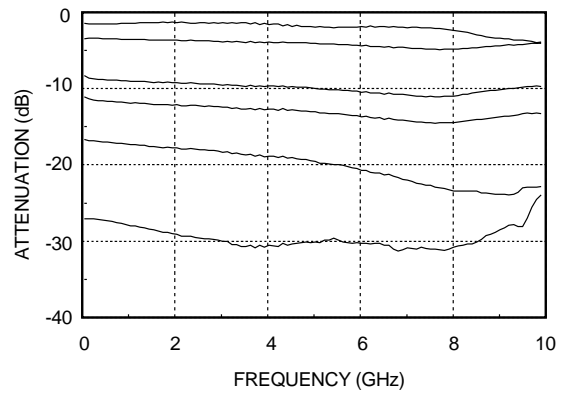

Return Loss

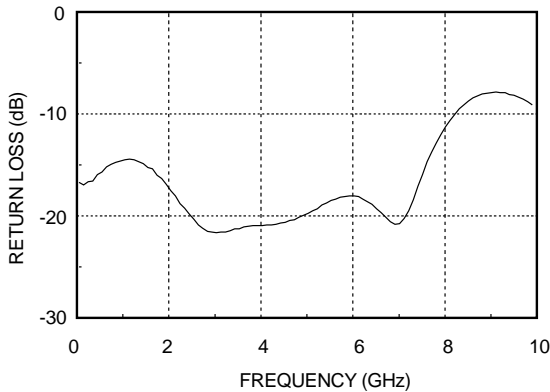

Relative Attenuation vs. Control Voltage

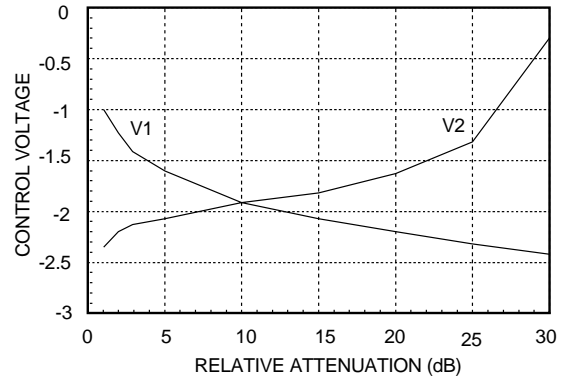

Relative Phase

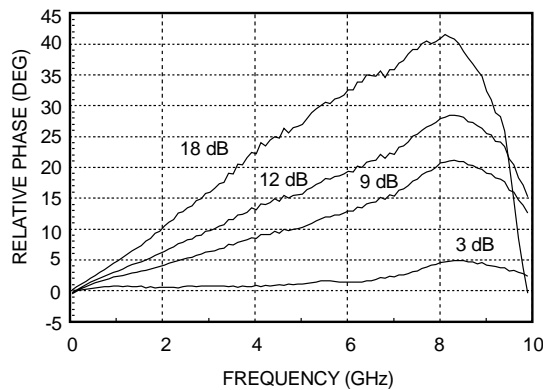

HMC121G8 SMT VOLTAGE-VARIABLE ATTENUATOR DC - 8 GHz

FEBRUARY 2001

2

SMT ATTENUATORS

Input Third Order Intercept vs. Attenuation

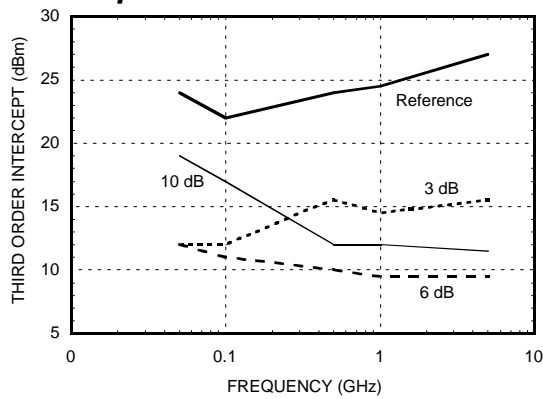

Input Second Order Intercept vs. Attenuation

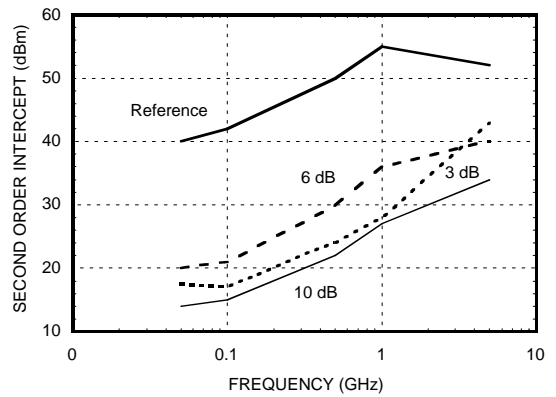

0.25 dB Compression vs. Attenuation

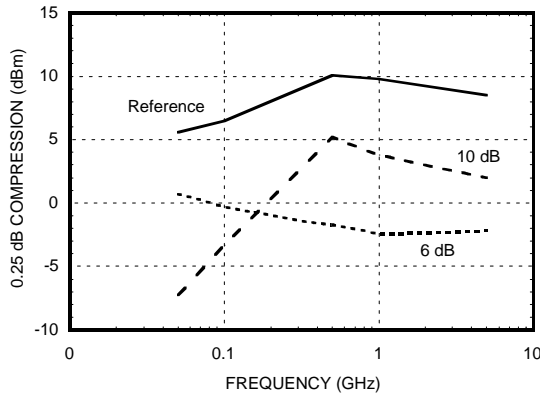

1 dB Compression vs. Attenuation

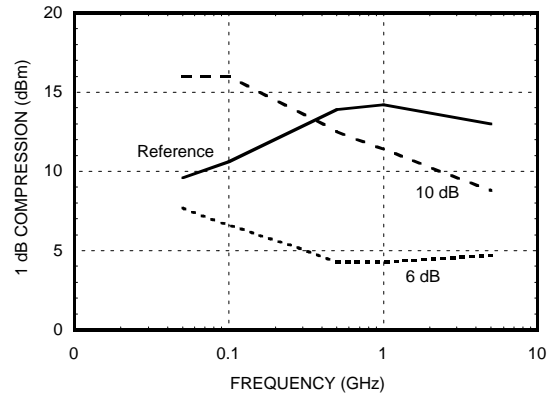

Second Harmonic vs. Attenuation

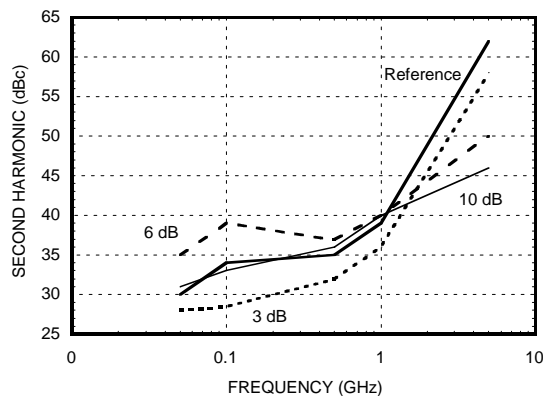

HMC121G8 SMT VOLTAGE-VARIABLE ATTENUATOR DC - 8 GHz

FEBRUARY 2001

Schematic

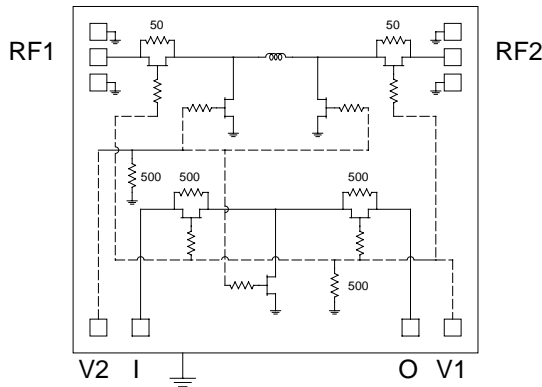

Absolute Maximum Ratings

RF Input	+16dBm
Control Voltage Range	+1.0 to -6.0 Vdc
Storage Temperature	-65 to +150 deg C
Operating Temperature	-55 to +125 deg C

Outline Drawing

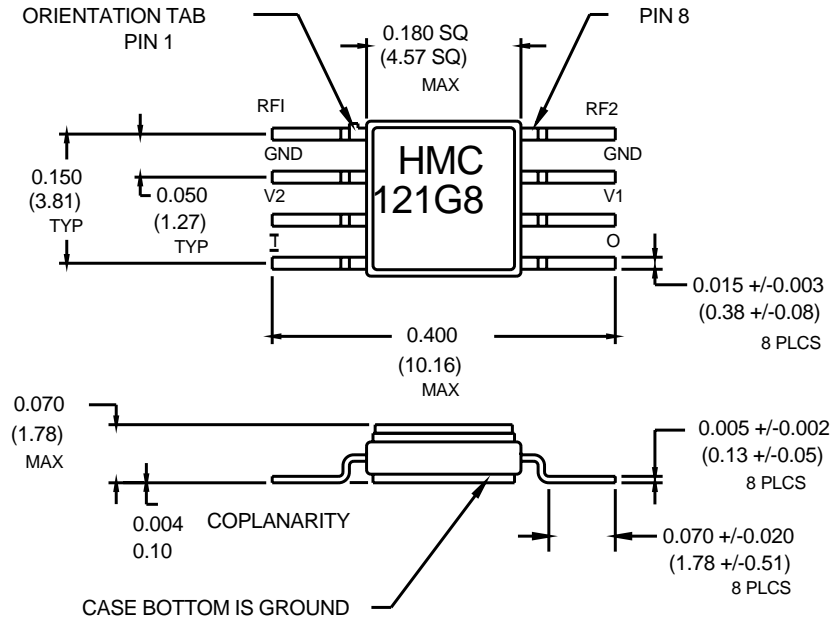

1. MATERIAL:
 - A) PACKAGE BODY - ALUMINA LOADED BOROSILICATE GLASS
 - B) LEADS, BASE, & COVER - ASTM F - 15 ALLOY
2. PLATING: ELECTROLYTIC GOLD 50 MICRO INCHES MINIMUM
3. DIMENSIONS ARE IN INCHES (MILLIMETERS), UNLESS OTHERWISE SPECIFIED
TOL. ARE ±0.005(±0.13)

HMC121G8 SMT VOLTAGE-VARIABLE ATTENUATOR DC - 8 GHz

FEBRUARY 2001

Single-Line Control Driver

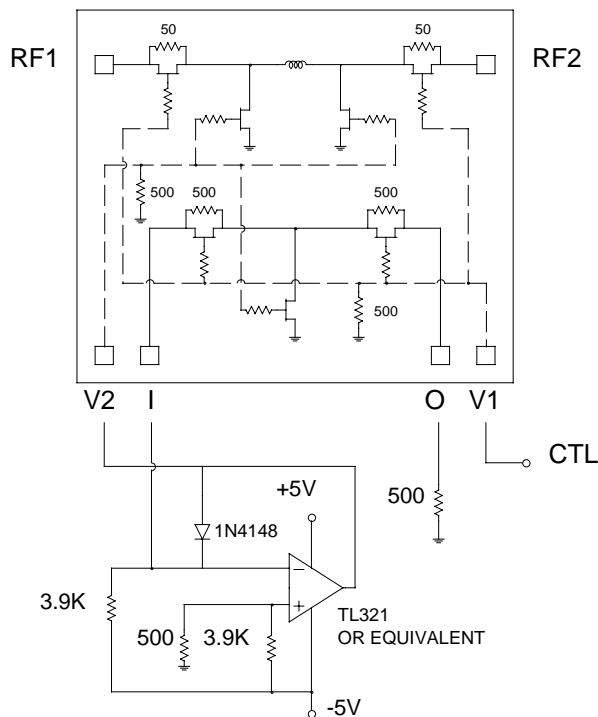

External op-amp control circuit maintains impedance match while attenuation is varied. Input control ranges from 0 Volts (min. attenuation) to -2.5 Volts (max. attenuation.)



HMC121G8

HMC121G8 SMT VOLTAGE-VARIABLE ATTENUATOR DC - 8 GHz

FEBRUARY 2001

NOTES:

2

SMT ATTENUATORS

