



v03.1202

HMC204MS8G

GaAs MMIC SMT PASSIVE FREQUENCY DOUBLER, 4 - 8 GHz INPUT

Typical Applications

The HMC204MS8G is suitable for:

- Wireless Local Loop
- LMDS, VSAT, and Pt to Pt Radios
- UNII & HiperLAN
- Test Equipment

Features

- Conversion Loss: 17 dB
- Fo, 3Fo, 4Fo Isolation: 42 dB
- Passive: No Bias Required
- Ultra Small Package: MSOP8

Functional Diagram

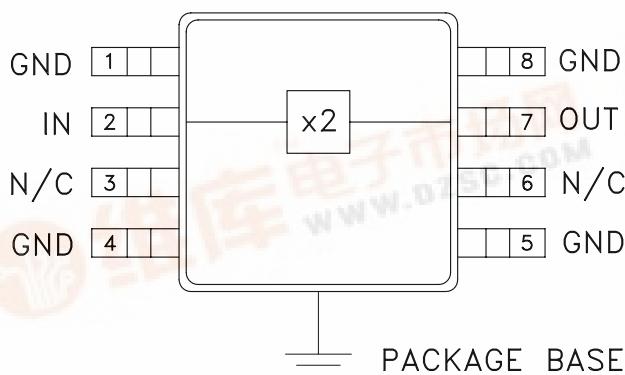

General Description

The HMC204MS8G is a passive miniature frequency doubler in an 8 lead MSOP surface mount package. Suppression of undesired fundamental and higher order harmonics is 42 dB typical with respect to input signal level. The doubler utilizes the same GaAs Schottky diode/balun technology found in Hittite MMIC mixers. It requires no DC bias and adds no measurable phase noise onto the multiplied signal.

Electrical Specifications, $T_A = +25^\circ C$, As a Function of Drive Level

Parameter	Input = +10 dBm			Input = +12 dBm			Input = +15 dBm			Units
	Min.	Typ.	Max.	Min.	Typ.	Max.	Min.	Typ.	Max.	
Frequency Range, Input	5.5 - 7.5			5.0 - 8.0			4.0 - 8.0			GHz
Frequency Range, Output	11.0 - 15.0			10.0 - 16.0			8.0 - 16.0			GHz
Conversion Loss		17	21		17	22		17	21	dB
FO Isolation (with respect to input level)	37	42		37	42		39	45		dB
3FO Isolation (with respect to input level)	37	45		37	45		35	45		dB
4FO Isolation (with respect to input level)	45	55		40	50		35	45		dB



GaAs MMIC SMT FREQUENCY DOUBLER, 4 - 8 GHz INPUT

Conversion Gain vs. Temperature @ +15 dBm Drive Level

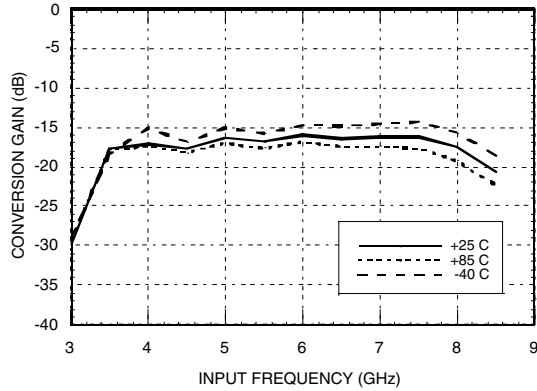

Conversion Gain @ +25° vs. Drive Level

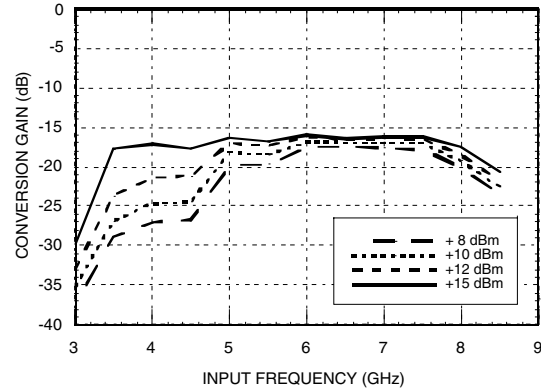

Isolation @ +15 dBm Drive Level*

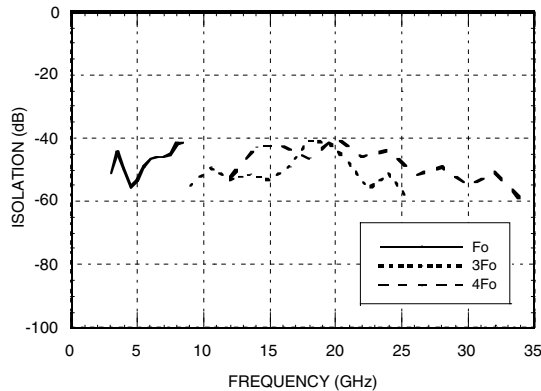

Input Return Loss vs. Drive Level

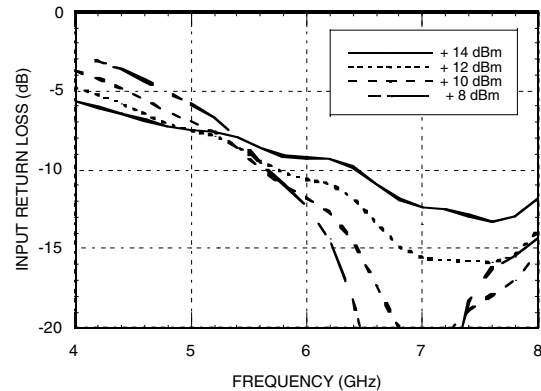

*With respect to input level

Output Return Loss

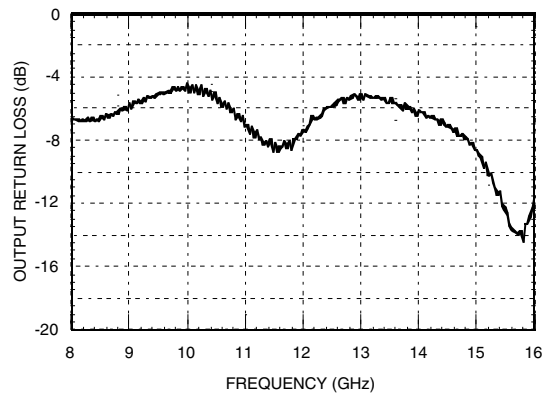

GaAs MMIC SMT FREQUENCY DOUBLER, 4 - 8 GHz INPUT

Absolute Maximum Ratings

Input Drive	+27 dBm
Storage Temperature	-65 to +150 °C
Operating Temperature	-40 to +85 °C

Outline Drawing

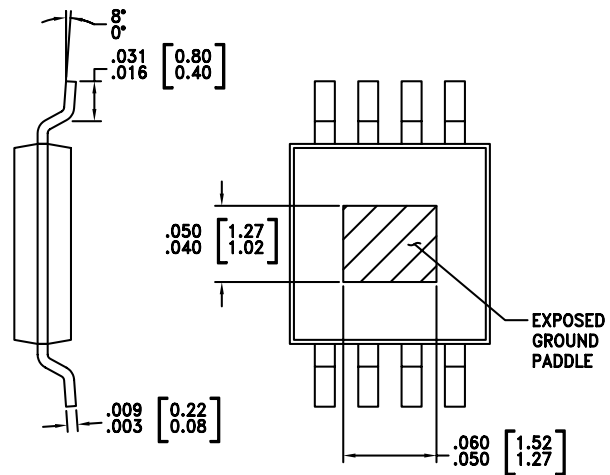
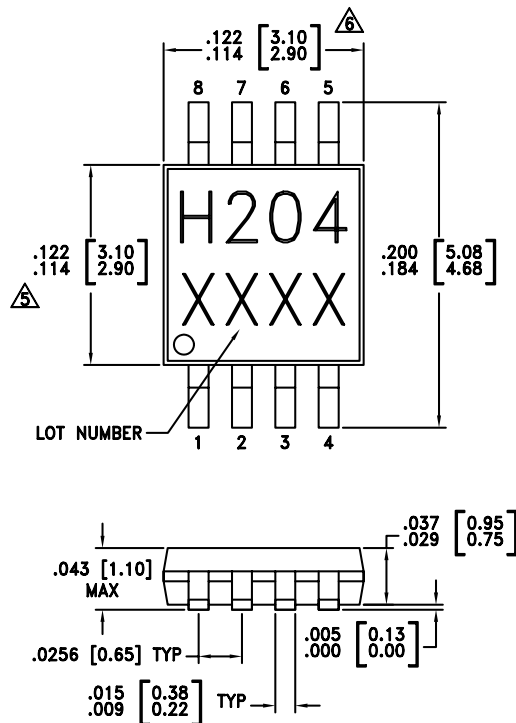

NOTES:

1. PACKAGE BODY MATERIAL: LOW STRESS INJECTION MOLDED PLASTIC SILICA AND SILICON IMPREGNATED.
2. LEADFRAME MATERIAL: COPPER ALLOY
3. LEADFRAME PLATING: Sn/Pb SOLDER
4. DIMENSIONS ARE IN INCHES [MILLIMETERS].
- △ DIMENSION DOES NOT INCLUDE MOLDFLASH OF 0.15 mm PER SIDE.
- △ DIMENSION DOES NOT INCLUDE MOLDFLASH OF 0.25 mm PER SIDE.
7. ALL GROUND LEADS MUST BE SOLDERED TO PCB PF GROUND.

GaAs MMIC SMT FREQUENCY DOUBLER, 4 - 8 GHz INPUT

Evaluation PCB

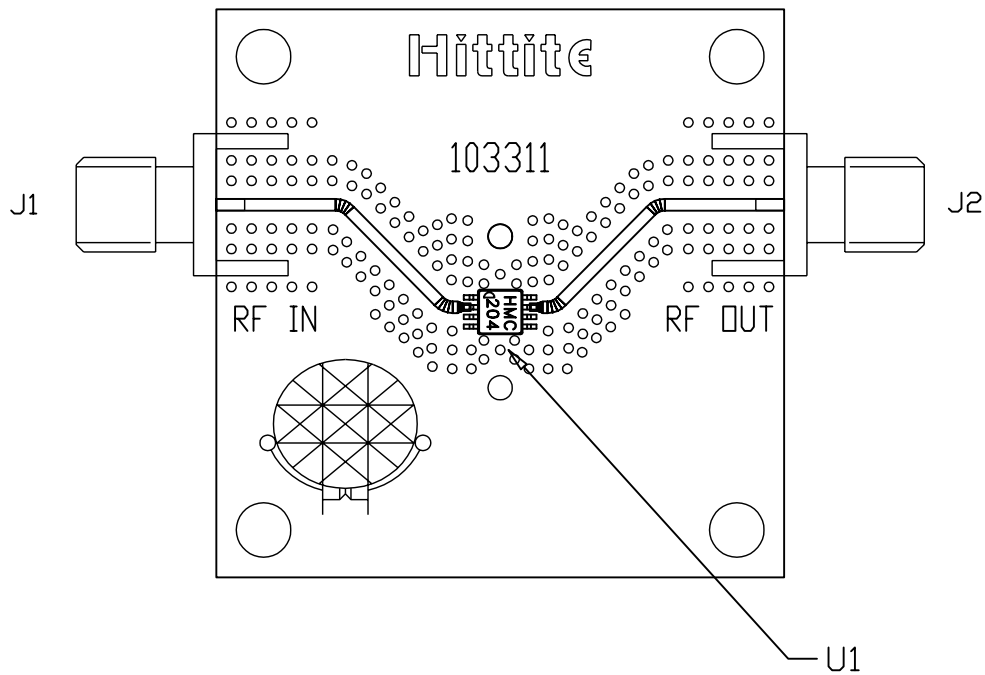

The circuit board used in the final application should be generated with proper RF circuit design techniques. Signal lines at the RF port should have 50 ohm impedance and the package ground leads and exposed ground paddle should be connected directly to the ground plane similar to that shown above. The evaluation circuit board shown above is available from Hittite Microwave Corporation upon request.

List of Materials

Item	Description
J1, J2	PC Mount SMA Connector
U1	HMC204MS8G
PCB*	103311 Eval Board
*Circuit Board Material: Rogers 4350	