



v00.1102

HMC335G16

1dB LSB GaAs MMIC 5-BIT DIGITAL ATTENUATOR, DC - 3 GHz

Typical Applications

The HMC335G16 is ideal for:

- Telecom Infrastructure
- Military Radios, Radar & ECM
- Space Applications
- Test Instrumentation

Functional Diagram

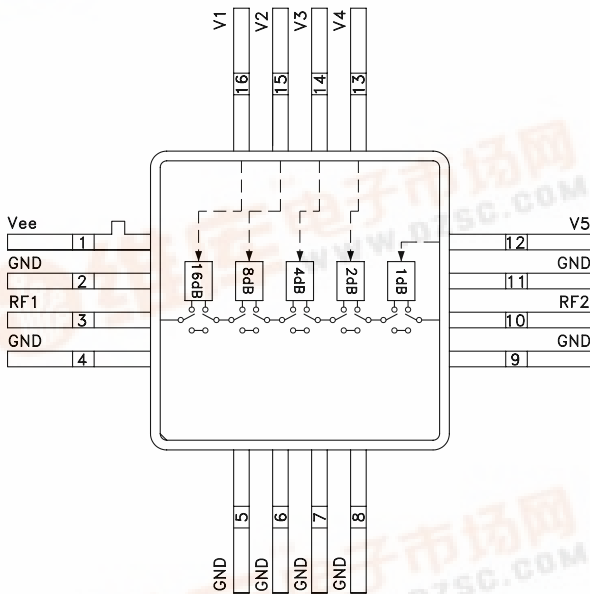

Features

- 1 dB LSB Steps to 31 dB
- Single Control Line Per Bit
- +/- 0.5 dB Typical Bit Error
- 16 Lead Hermetic SMT Package

General Description

The HMC335G16 is a broadband 5-bit GaAs IC digital attenuator in a 16 lead glass/metal (hermetic) surface mount package. Covering DC to 3 GHz, the insertion loss is less than 2.3 dB typical. The attenuator bit values are 1 (LSB), 2, 4, 8, and 16 dB for a total attenuation of 31 dB. Attenuation accuracy is excellent at ± 0.5 dB typical with an IIP3 of up to +44 dBm. Five bit control voltage inputs, toggled between 0 and -5V, are used to select each attenuation state at less than 70 μ A each. A single Vee bias of -5V allows operation down to DC.

Electrical Specifications, $T_A = +25^\circ C$, $V_{ee} = -5V$ & $V_{ctl} = 0/V_{ee}$

Parameter	Frequency	Min.	Typical	Max.	Units
Insertion Loss	DC - 1.5 GHz		2.0	2.5	dB
	1.5 - 3.0 GHz		2.3	2.8	dB
Attenuation Range	DC - 3.0 GHz		31		dB
Return Loss (RF1 & RF2, All Atten. States)	DC - 3.0 GHz		13		dB
Attenuation Accuracy: (Referenced to Insertion Loss)					
1 - 31 dB States	DC - 1.0 GHz	$\pm 0.3 + 5\%$ of Atten. Setting Max			dB
1 - 27 dB States	1.0 - 2.0 GHz	$\pm 0.3 + 5\%$ of Atten. Setting Max			dB
28 - 31 dB States	1.0 - 2.0 GHz	$\pm 0.3 + 8\%$ of Atten. Setting Max			dB
1 - 23 dB States	2.0 - 3.0 GHz	$\pm 0.3 + 5\%$ of Atten. Setting Max			dB
24 - 27 dB States	2.0 - 3.0 GHz	$\pm 0.3 + 8\%$ of Atten. Setting Max			dB
28 - 31 dB States	2.0 - 3.0 GHz	$\pm 0.5 + 10\%$ of Atten. Setting Max			dB
Input Power for 0.1 dB Compression	0.5 - 3.0 GHz		24		dBm
Input Third Order Intercept Point (Two-tone Input Power = 0 dBm Each Tone)	0.5 - 3.0 GHz		44		dBm
Switching Characteristics	DC - 3.0 GHz				
tRISE, tFALL (10/90% RF)			140		ns
tON, tOFF (50% CTL to 10/90% RF)			160		ns



1dB LSB GaAs MMIC 5-BIT DIGITAL ATTENUATOR, DC - 3 GHz

Insertion Loss

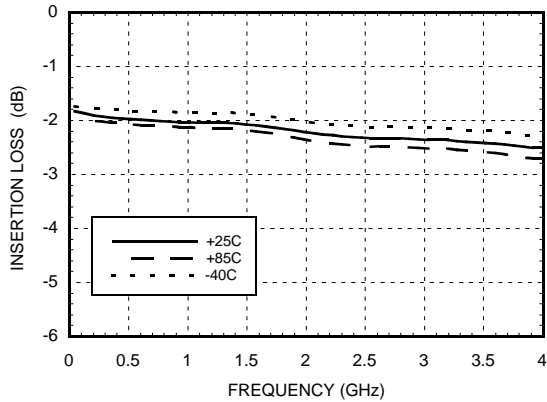

Return Loss RF1, RF2 (Only Major States are Shown)

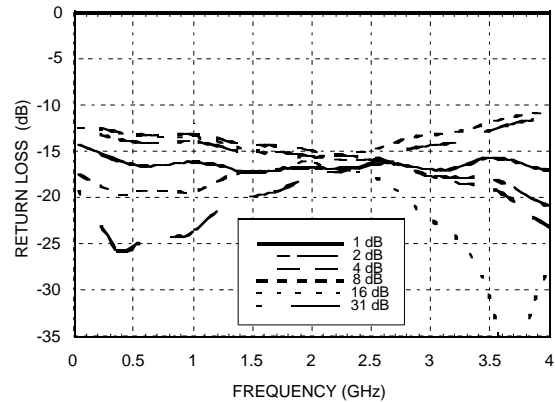

Normalized Attenuation (Only Major States are Shown)

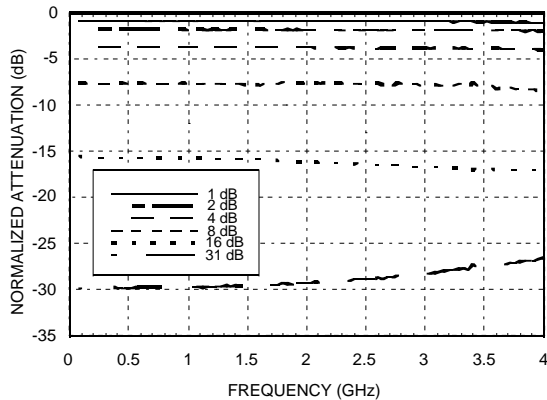

Bit Error vs. Attenuation State

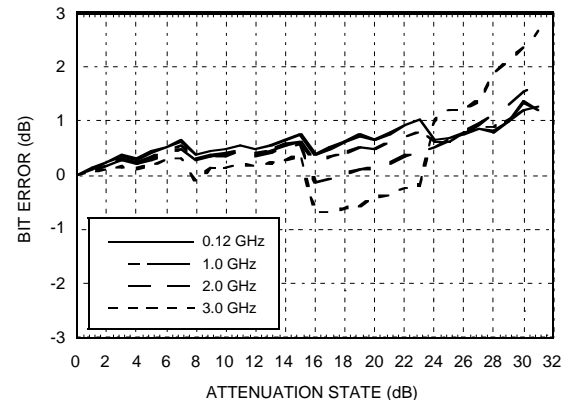

Bit Error vs. Frequency (Only Major States are Shown)

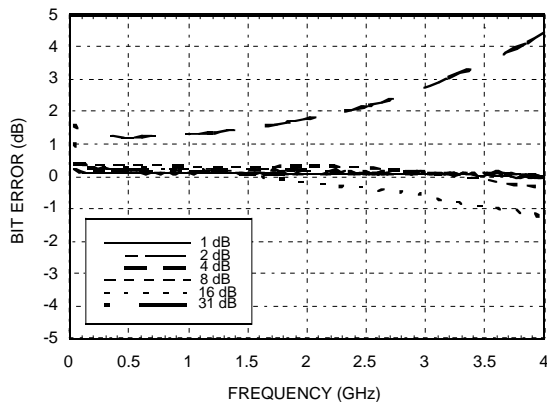

Relative Phase vs. Frequency (Only Major States are Shown)

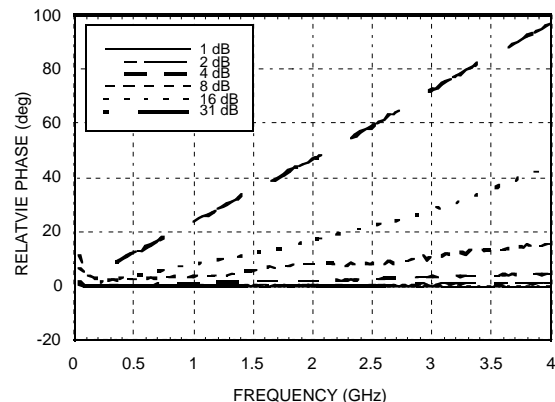

1dB LSB GaAs MMIC 5-BIT DIGITAL ATTENUATOR, DC - 3 GHz

**Worst Case Step Error
Between Successive Attenuation States**

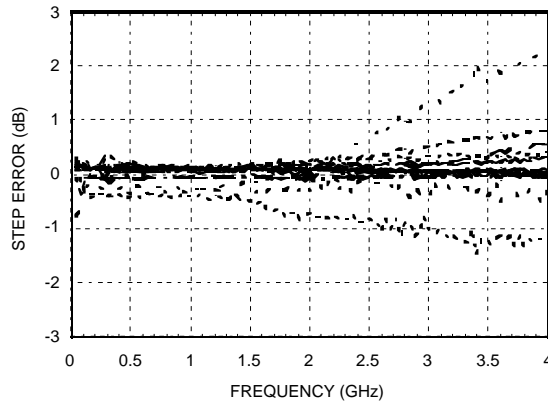

Bias Voltage & Current

Vee Range = -5.0 Vdc ± 10%		
Vee (VDC)	Iee (Typ.) (mA)	Iee (Max.) (mA)
-5.0	3	6

Control Voltage

State	Bias Condition
Low	0 to -2V @ 70 µA Typ.
High	Vee to Vee + 0.8V @ 5 µA Typ.

Note: Vee = -5V ± 10%

Absolute Maximum Ratings

Control Voltage (V1 - V5)	Vee - 0.5 Vdc
Bias Voltage (Vee)	-7.0 Vdc
Storage Temperature	-65 to +150 °C
Operating Temperature	-40 to +85 °C
RF Input Power (0.5 - 3 GHz)	+26 dBm

Truth Table

Control Voltage Input					Attenuation State RF1 - RF2
V1 16 dB	V2 8 dB	V3 4 dB	V4 2 dB	V5 1 dB	
Low	Low	Low	Low	Low	Reference I.L.
Low	Low	Low	Low	High	1 dB
Low	Low	Low	High	Low	2 dB
Low	Low	High	Low	Low	4 dB
Low	High	Low	Low	Low	8 dB
High	Low	Low	Low	Low	16 dB
High	High	High	High	High	31 dB Max. Atten.

Any combination of the above states will provide an attenuation approximately equal to the sum of the bits selected.

1dB LSB GaAs MMIC 5-BIT DIGITAL ATTENUATOR, DC - 3 GHz

Outline Drawing

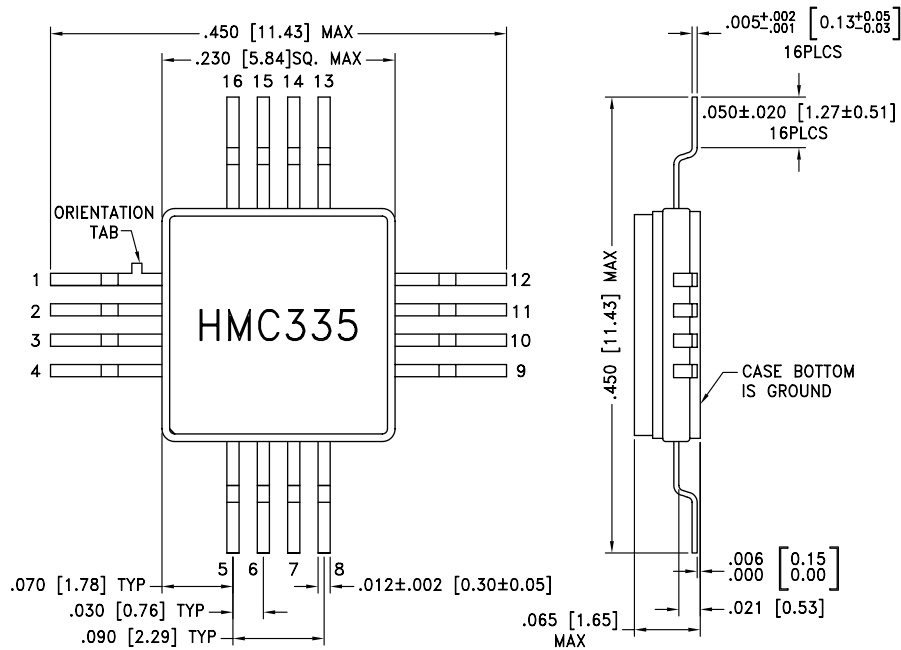

NOTES:

1. PACKAGE MATERIAL: ALUMINA LOADED BOROSILICATE GLASS.
2. LEADS, BASE, COVER MATERIAL: KOVARTM (#7052 CORNING).
3. PLATING: ELECTROLYTIC GOLD 50 MICROINCHES MIN., OVER ELECTROLYTIC NICKEL 75 MICROINCHES MIN.
4. ALL DIMENSIONS ARE IN INCHES [MILLIMETERS].
5. TOLERANCES: 0.005 [.013] UNLESS OTHERWISE SPECIFIED.
6. CHARACTERS TO BE HELVETICA MEDIUM .030 HIGH, BLACK INK, LOCATED APPROX. AS SHOWN.
7. ALL GROUND LEADS AND GROUND PADDLE MUST BE SOLDERED TO PCB RF GROUND.

Pin Descriptions

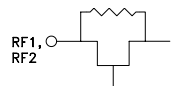
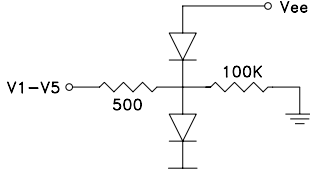
Pin Number	Function	Description	Interface Schematic
1	Vee	Supply Voltage -5V ±10%	
2, 4-9, 11	GND	Package bottom must also be connected to RF ground.	
3, 10	RF1, RF2	These pins are DC coupled and matched to 50 Ohm. Blocking capacitors are required.	
12-16	V1-V5	See truth table and control voltage table.	

1dB LSB GaAs MMIC 5-BIT DIGITAL ATTENUATOR, DC - 3 GHz

Application Circuit

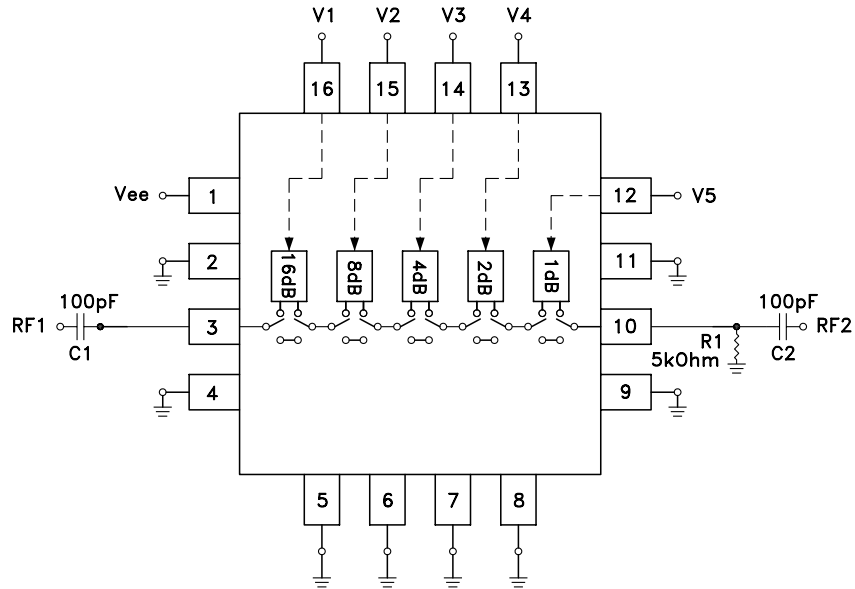

DC Blocking Capacitors C1 & C2 are required on RF1 & RF2. Choose C1 = C2 = 100 pF ~ 0.1 uF to allow lowest customer specific frequency to pass with minimal loss. R1= 5K Ohm is required to supply voltage to the circuit through either Pin 3 or Pin 10.

Suggested Driver Circuit

(One Circuit Required Per Bit Control Input)

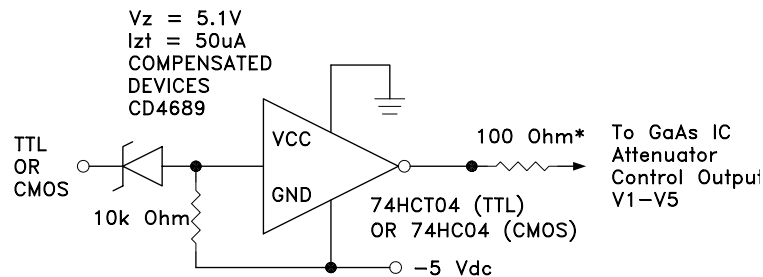

Simple driver using inexpensive standard logic ICs provides fast switching using minimum DC current. * Recommended value to suppress unwanted RF signals at V1 - V5 control lines.

1dB LSB GaAs MMIC 5-BIT DIGITAL ATTENUATOR, DC - 3 GHz

Evaluation PCB

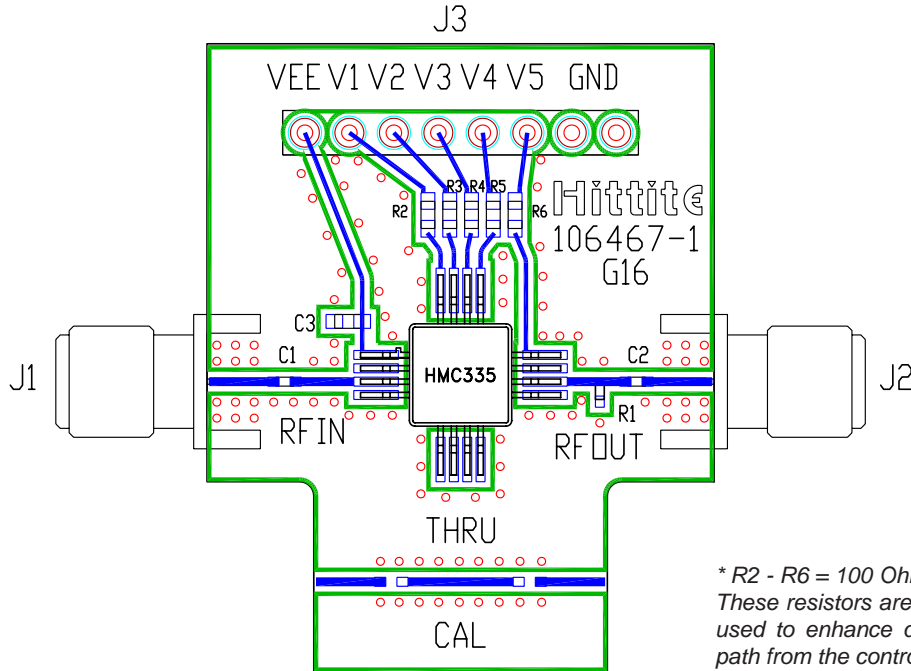

List of Material

Item	Description
J1 - J2	PC Mount SMA Connector
J3	DC Connector
R1	5k Ohm Resistor 0402 Pkg.
R2 - R6	100 Ohm Resistor, 0402 Pkg.
C1, C2	0402 Chip Capacitor, Select Value for Lowest Frequency of Operation
C3	1000pF Capacitor, 0603 Pkg.
U1	HMC335G16 Digital Attenuator
PCB*	106467 Evaluation PCB
*Circuit Board Material: Rogers 4350	

The circuit board used in the final application should use RF circuit design techniques. Signal lines should have 50 ohm impedance while the package ground leads and package bottom should be connected directly to the ground plane similar to that shown. A sufficient number of via holes should be used to connect the top and bottom ground planes. The evaluation circuit board shown is available from Hittite upon request.