



v03.0304

HMC346MS8G

GaAs MMIC SMT VOLTAGE-VARIABLE ATTENUATOR, DC - 8 GHz

Typical Applications

This attenuator is ideal for use as a VVA for DC - 8 GHz applications:

- Point-to-Point Radio
- VSAT Radio

Features

- Wide Bandwidth: DC - 8 GHz
- Low Phase Shift vs. Attenuation
- 32 dB Attenuation Range

Functional Diagram

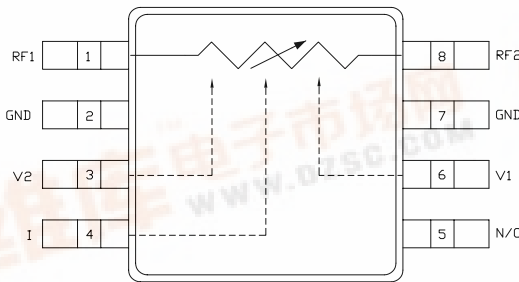

General Description

The HMC346MS8G is an absorptive Voltage Variable Attenuator (VVA) in an 8 lead surface-mount package operating from DC - 8 GHz. It features an on-chip reference attenuator for use with an external op-amp to provide simple single voltage attenuation control, 0 to -3V. The device is ideal in designs where an analog DC control signal must control RF signal levels over a 30 dB amplitude range. Applications include AGC circuits and temperature compensation of multiple gain stages in microwave point-to-point and VSAT radios.

Electrical Specifications, $T_A = +25^\circ\text{C}$, 50 ohm system

Parameter	Min	Typical	Max	Units
Insertion Loss DC - 8 GHz		1.5	2.5	dB
Attenuation Range DC - 8 GHz	27	32		dB
Return Loss DC - 8 GHz	5	10		dB
Switching Characteristics				
tRISE, tFALL (10/90% RF)		2		ns
tON, tOFF (50% CTL to 10/90% RF)		8		ns
Input Power for 0.25 dB Compression (0.5 - 8 GHz)				
Min. Atten. Atten. >2 dB		+8 -2		dBm dBm
Input Third Order Intercept (0.5 - 8 GHz) (Two-tone Input Power = -8 dBm Each Tone)				
Min. Atten. Atten. >2 dB		+25 +10		dBm dBm

For price, delivery, and to place orders, please contact Hittite Microwave Corporation:
12 Elizabeth Drive, Chelmsford, MA 01824 Phone: 978-250-3343 Fax: 978-250-3373
Order Online at www.hittite.com



GaAs MMIC SMT VOLTAGE-VARIABLE ATTENUATOR, DC - 8 GHz

Insertion Loss vs. Temperature

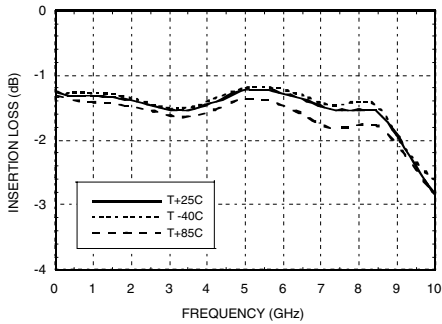

Relative Attenuation

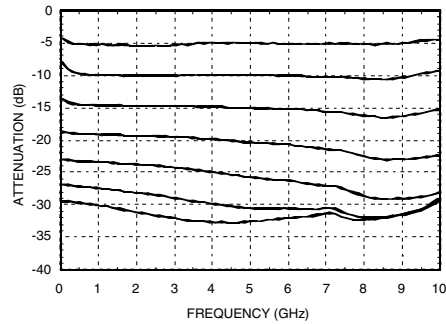

Return Loss vs. Attenuation

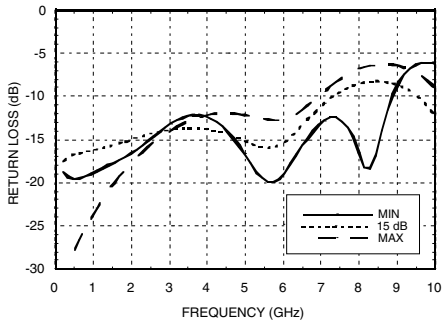

Relative Attenuation vs. Control Voltage @ 4 GHz

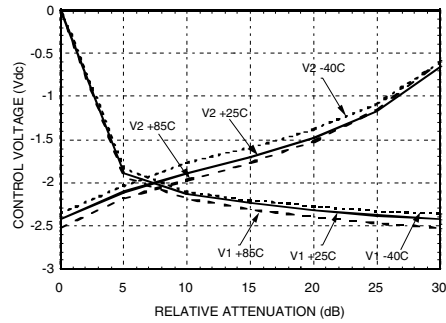

Relative Phase

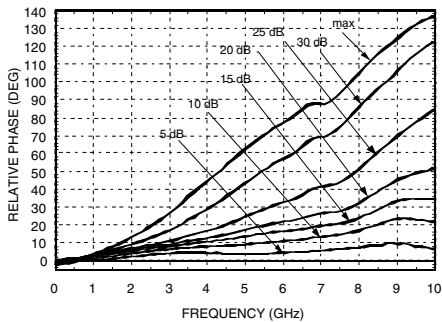

Relative Attenuation vs. Control Voltage @ 8 GHz

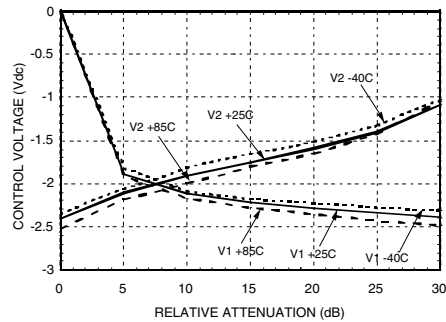

GaAs MMIC SMT VOLTAGE-VARIABLE ATTENUATOR, DC - 8 GHz

Input Third Order Intercept vs Attenuation*

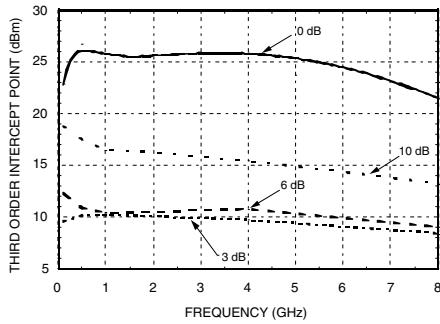

Input Second Order Intercept vs. Attenuation*

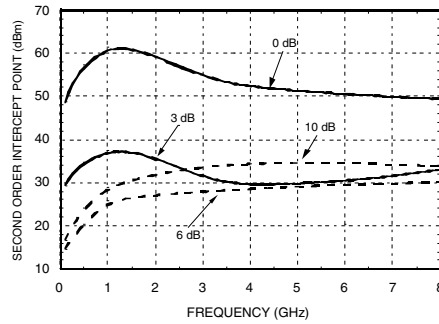

0.25 dB Compression vs. Attenuation

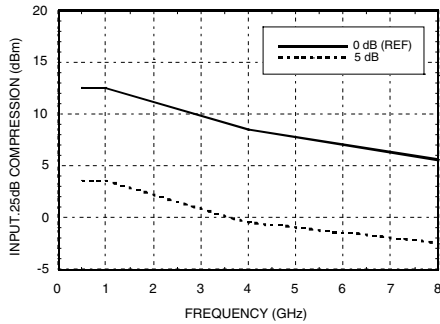

1 dB Compression vs. Attenuation

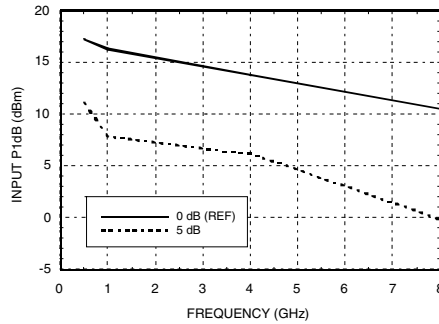

Second Harmonic vs. Attenuation

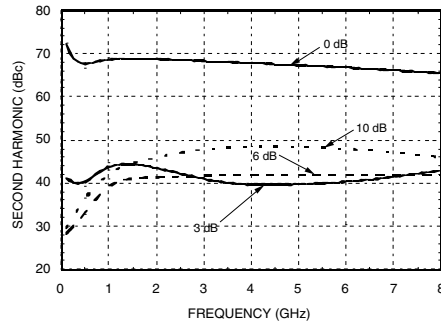

*Two-tone input power = -8 dBm each tone, 1 MHz spacing.

GaAs MMIC SMT VOLTAGE-VARIABLE ATTENUATOR, DC - 8 GHz

Absolute Maximum Ratings

RF Input Power	+18 dBm
Control Voltage Range	+1.0 to -5.0 Vdc
Storage Temperature	-65 to +150 °C
Operating Temperature	-40 to +85 °C

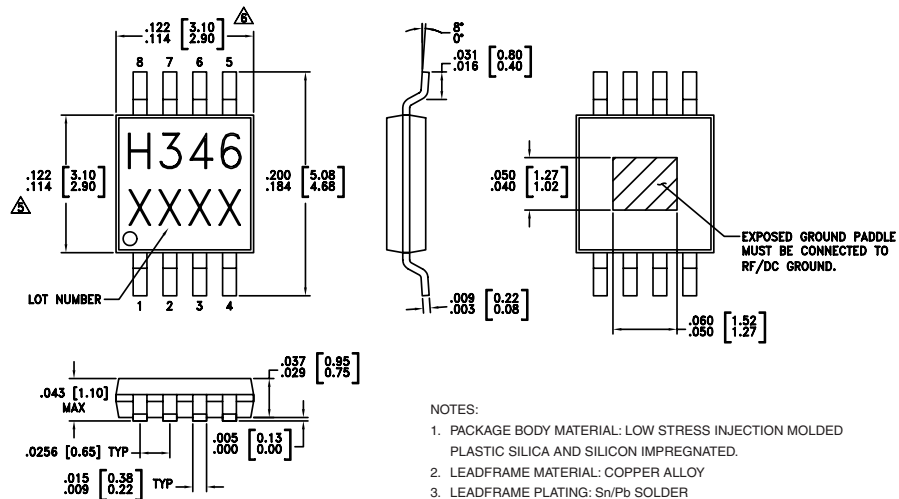

Outline Drawing



- NOTES:
1. PACKAGE BODY MATERIAL: LOW STRESS INJECTION MOLDED PLASTIC SILICA AND SILICON IMPREGNATED.
 2. LEADFRAME MATERIAL: COPPER ALLOY
 3. LEADFRAME PLATING: Sn/Pb SOLDER
 4. DIMENSIONS ARE IN INCHES [MILLIMETERS].
 5. DIMENSION DOES NOT INCLUDE MOLDFLASH OF 0.15mm PER SIDE.
 6. DIMENSION DOES NOT INCLUDE MOLDFLASH OF 0.25mm PER SIDE.
 7. ALL GROUND LEADS AND GROUND PADDLE MUST BE SOLDERED TO PCB RF GROUND.

GaAs MMIC SMT VOLTAGE-VARIABLE ATTENUATOR, DC - 8 GHz

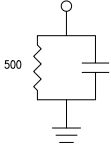
Pin Descriptions

Pin Number	Function	Description	Interface Schematic
1, 8	RF1 RF2	This pin is DC coupled and matched to 50 Ohm. Blocking capacitors are required if RF line potential is not equal to 0V.	
2, 7	GND	This pin must be DC grounded.	
3, 6	V2, V1	Control Input (Master).	
4	I	Control Input (Slave).	
5	N/C	Not Connected.	

Single-Line Control Driver

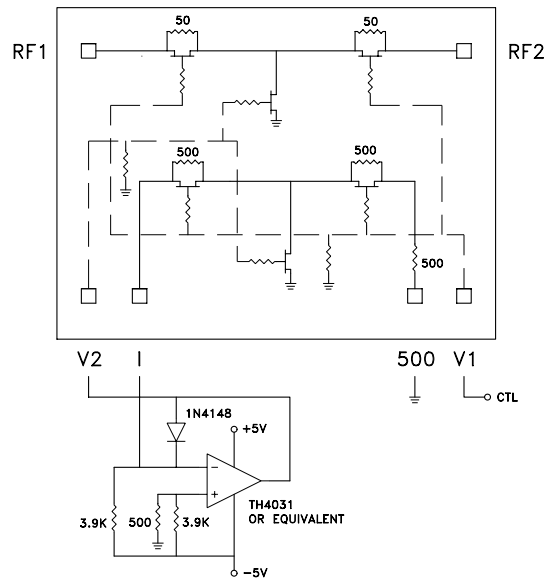

External op-amp control circuit maintains impedance match while attenuation is varied. Input control ranges from 0 Volts (min. attenuation) to -2.5 Volts (max. attenuation).

For price, delivery, and to place orders, please contact Hittite Microwave Corporation:
 12 Elizabeth Drive, Chelmsford, MA 01824 Phone: 978-250-3343 Fax: 978-250-3373
 Order Online at www.hittite.com

**GaAs MMIC SMT VOLTAGE-VARIABLE
ATTENUATOR, DC - 8 GHz**

Evaluation PCB

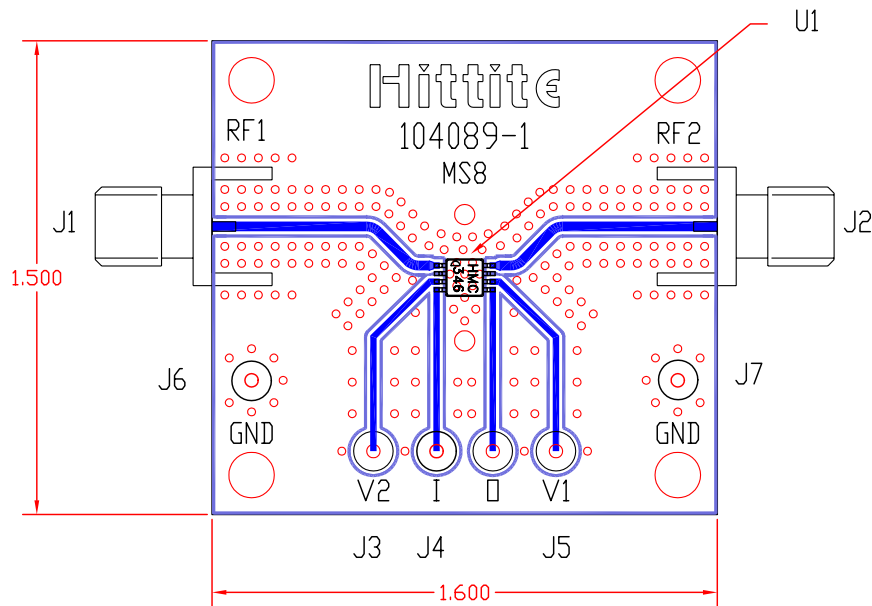

The circuit board used in the final application should be generated with proper RF circuit design techniques. Signal lines at the RF ports should be 50 ohm impedance and the package ground leads and package bottom should be connected directly to the PCB RF ground plane, similar to that shown above. The evaluation circuit board shown above is available from Hittite Microwave Corporation upon request.

List of Material

Item	Description
J1 - J2	PC Mount SMA RF Connector
J3 - J7	DC PIN
U1	HMC346MS8G
PCB*	104089 Eval Board
*Circuit Board Material: Rogers 4350	