



v02.0604

HMC368LP4

SMT GaAs PHEMT MMIC AMP-DOUBLER-AMP, 9.0 - 16.0 GHz OUTPUT

Typical Applications

- Microwave Radios & VSAT
- Fiber Optic Infrastructure
- Military Communications & Radar

Features

- Output Power: +15 dBm
- Wide Input Power Range: 0 to +10 dBm
- 100 kHz SSB Phase Noise: -140 dBc/Hz
- +5V @ 75 mA Supply
- 16 mm² Leadless QFN SMT Package

Functional Diagram

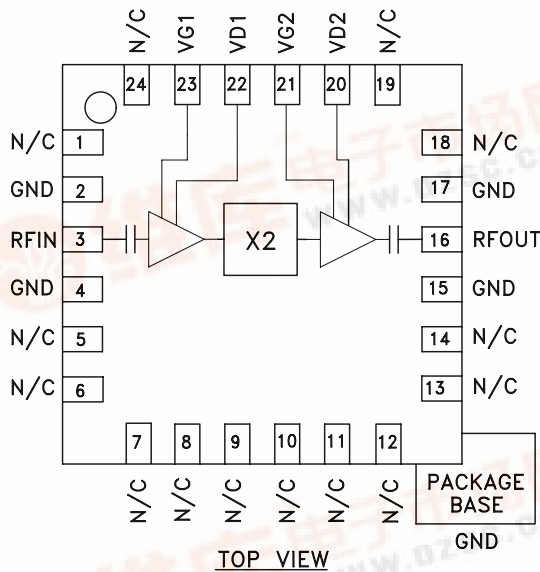

General Description

The HMC368LP4 is a miniature amp-doubler-amp utilizing GaAs PHEMT technology in a 4 mm x 4 mm leadless surface mount package. When driven by a +2 dBm signal, the multiplier provides +15 dBm typical output power from 9 to 16 GHz. The Fo and the 3Fo isolations are 18 dB typical. The low additive SSB phase noise of -140 dBc/Hz at 100 kHz offset helps the user maintain good system noise performance. The HMC368LP4 is ideal for use in LO multiplier chains allowing reduced parts count vs. traditional approaches.

Electrical Specifications, $T_A = +25^\circ C$, $V_{d1} = V_{d2} = +5.0 V_{dc}$, +2 dBm Drive Level

Parameter	Min.	Typ.	Max.	Units
Frequency Range, Input		4.5 - 8.0		GHz
Frequency Range, Output		9.0 - 16.0		GHz
Output Power	12	15		dBm
Fo Isolation (with respect to output level)		18		dB
3Fo Isolation (with respect to output level)		18		dB
Input Return Loss		10		dB
Output Return Loss		10		dB
SSB Phase Noise (Fout = 13 GHz, 100 kHz Offset)		-140		dBc/Hz
Supply Current (Idd)*		75		mA

* Adjust Vg1, Vg2 between -2V to 0V to achieve Idd = 75 mA typical



SMT GaAs PHEMT MMIC AMP-DOUBLER-AMP, 9.0 - 16.0 GHz OUTPUT

Output Power vs. Temperature @ +2 dBm Drive Level

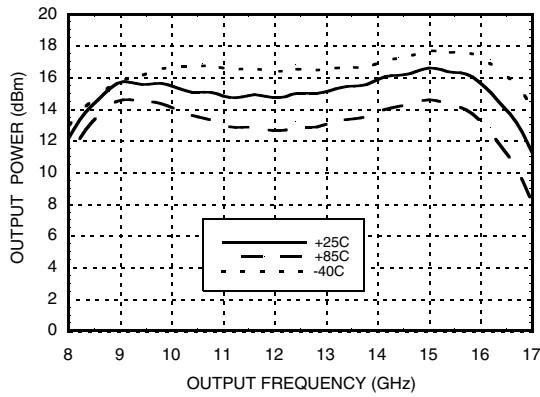

Output Power vs. Drive Level

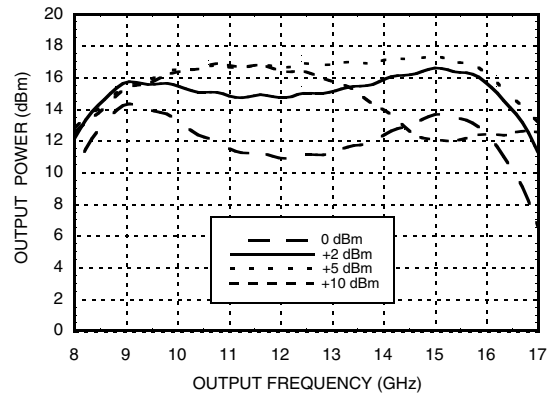

Output Power vs. Supply Voltage @ +2 dBm Drive Level

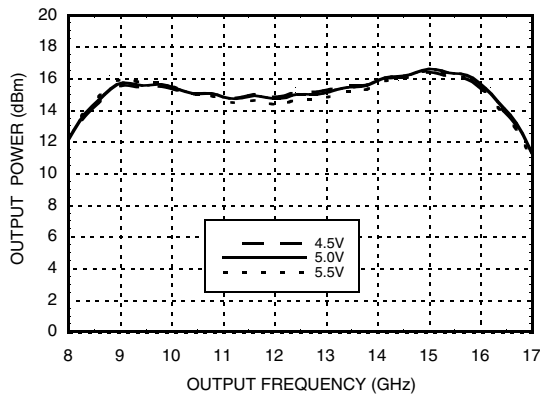

Isolation @ +2 dBm Drive Level

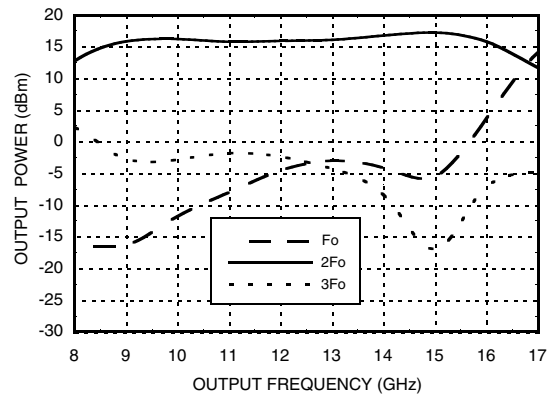

Input Return Loss vs. Temperature

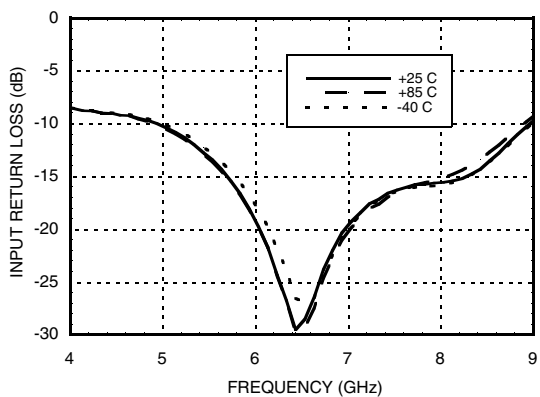

Output Return Loss vs. Temperature

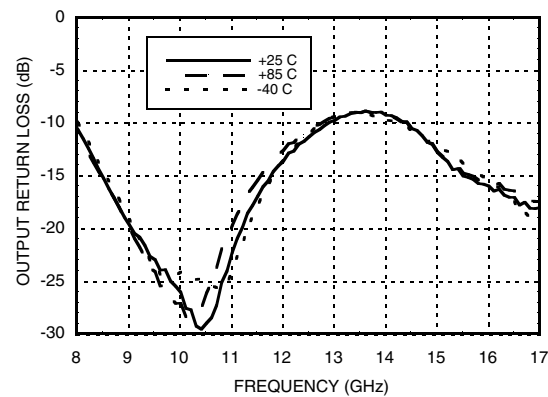

SMT GaAs PHEMT MMIC AMP-DOUBLER-AMP, 9.0 - 16.0 GHz OUTPUT

**Output Spectrum @ $F_{in} = 6.5$ GHz,
 $P_{in} = +2$ dBm**

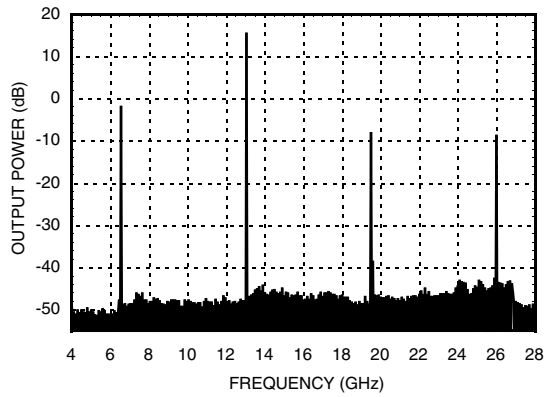

**Output Power vs. Input Power
@ Three Frequencies**

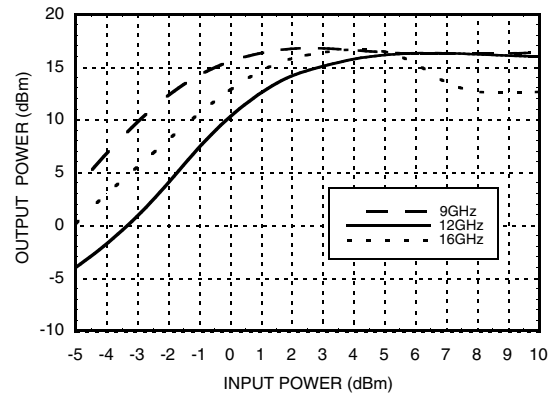

**SSB Phase Noise
Performance, $F_{out} = 13$ GHz,
Input Power = +2 dBm**

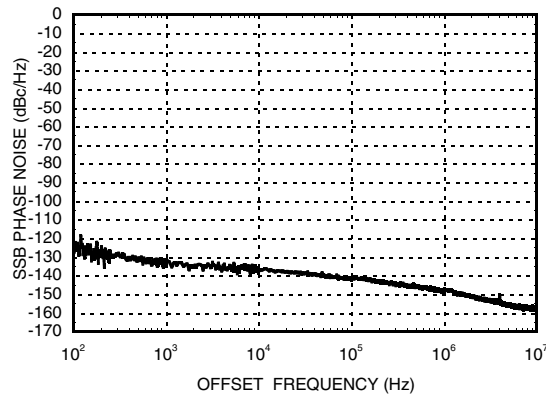

SMT GaAs PHEMT MMIC AMP-DOUBLER-AMP, 9.0 - 16.0 GHz OUTPUT

Absolute Maximum Ratings

RF Input (Vdd = +5V)	+20 dBm
Supply Voltage, Vd1, Vd2	+6.0V
Gate Bias Voltage (Vg1, Vg2)	-4 to 0 Vdc
Channel Temperature	150 °C
Continuous Pdiss (T = 85 °C) (derate 12.5 mW/°C above 85 °C)	812 mW
Thermal Resistance (junction to ground paddle)	80 °C/W
Storage Temperature	-65 to +150 °C
Operating Temperature	-40 to +85 °C

Typical Supply Current vs. Vdd

Vdd (V)	Idd (mA)
4.5	73
5.0	75
5.5	77

Note: Amp-Doubler-Amp will operate over full voltage range shown above.

11

Pin Locations & Outline Drawing

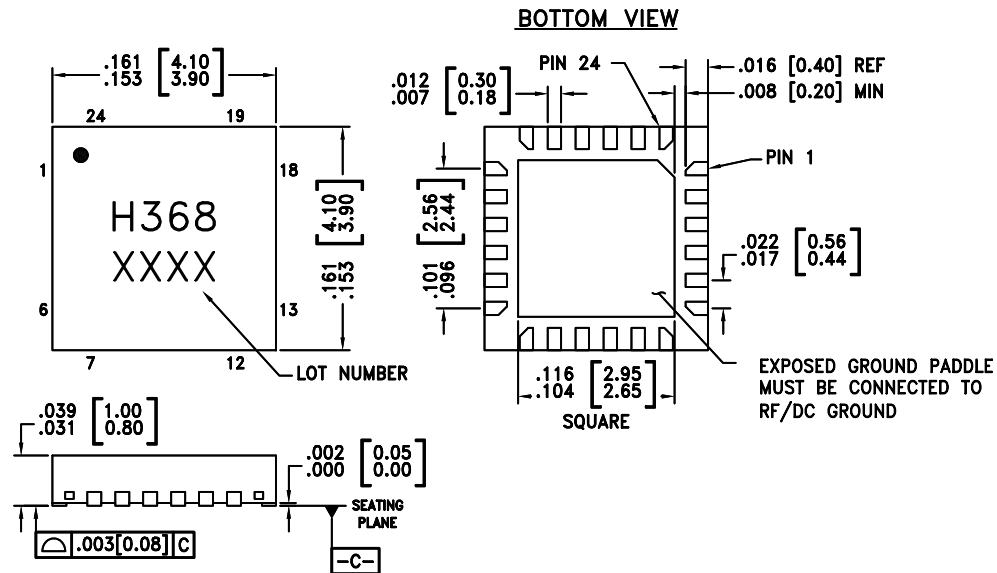



NOTES:

1. MATERIAL PACKAGE BODY: LOW STRESS INJECTION MOLDED PLASTIC SILICA AND SILICON IMPREGNATED.
2. LEAD AND GROUND PADDLE MATERIAL: COPPER ALLOY
3. LEAD AND GROUND PADDLE PLATING: Sn/Pb SOLDER
4. DIMENSIONS ARE IN INCHES [MILLIMETERS].
5. LEAD SPACING TOLERANCE IS NON-CUMULATIVE
6. PAD BURR LENGTH SHALL BE 0.15mm MAXIMUM. PAD BURR HEIGHT SHALL BE 0.05mm MAXIMUM.
7. PACKAGE WARP SHALL NOT EXCEED 0.05mm.
8. ALL GROUND LEADS AND GROUND PADDLE MUST BE SOLDERED TO PCB RF GROUND.
9. REFER TO HITTITE APPLICATION NOTE FOR SUGGESTED PCB LAND PATTERN.

SMT GaAs PHEMT MMIC AMP-DOUBLER-AMP, 9.0 - 16.0 GHz OUTPUT

Pin Description

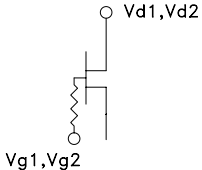
Pin Number	Function	Description	Interface Schematic
1, 5-14, 18, 19, 24	N/C	No Connection. These pins may be connected to RF ground. Performance will not be affected.	
3	RF IN	Multiplier Input. AC Coupled. No external DC blocks required.	
2, 4, 15, 17	GND	All ground leads and ground paddle must be soldered to PCB RF/DC ground.	
16	RF OUT	Multiplied Output. AC coupled. No external DC blocks necessary.	
20, 22	Vd2, Vd1	Drain supply voltage 5V ± 0.5V.	
21, 23	Vg2, Vg1	Gate supply voltages. Adjust between -2 Vdc to 0 Vdc to achieve 75 mA drain current.	

SMT GaAs PHEMT MMIC AMP-DOUBLER-AMP, 9.0 - 16.0 GHz OUTPUT

Evaluation PCB

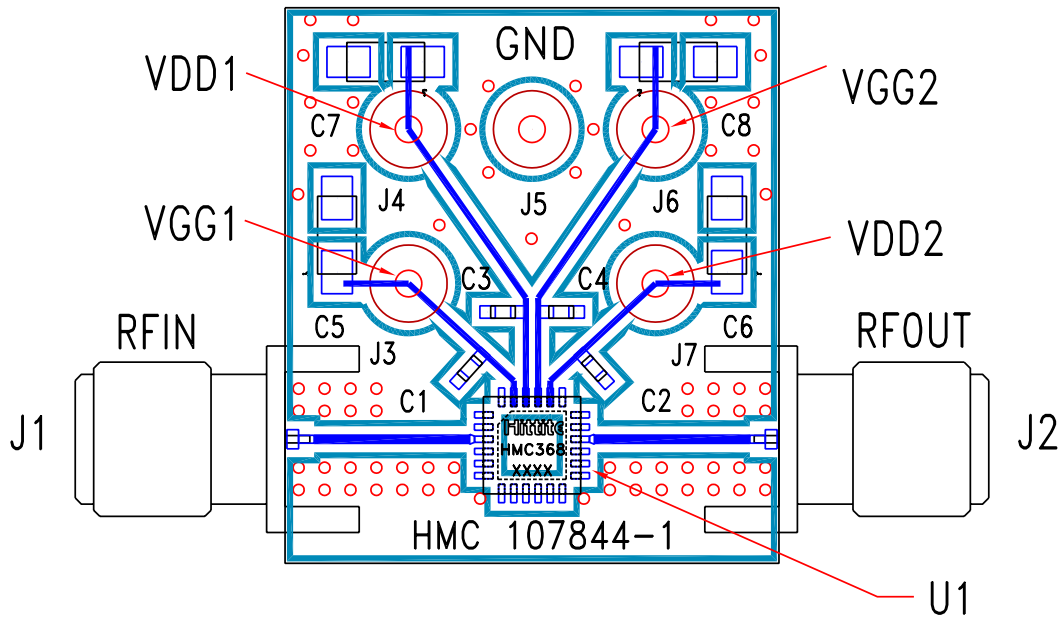

The circuit board used in the final application should be generated with proper RF circuit design techniques. Signal lines should have 50 ohm impedance while the package ground leads and exposed paddle should be connected directly to the ground plane similar to that shown. The evaluation circuit board shown is available from Hittite upon request.

List of Materials for Evaluation PCB 107846*

Item	Description
J1 - J2	PC Mount SMA Connector
J3 - J7	DC Pin
C1 - C4	100 pF capacitor, 0402 Pkg.
C5 - C8	2.2 μ F capacitor, case size A
U1	HMC368LP4, Amp-x2-Amp
PCB**	107844 PCB
** Circuit Board Material: Rogers 4350	

*Reference this number when ordering complete evaluation PCB.