



# 38 GHz LNA

## Technical Data

### HMMC-5038

#### Features

- **Low Noise Figure:** 4.8 dB
- **Frequency Range:** 37–40 GHz
- **High Gain (Adjustable):**  
3 V, 120 mA @ 23 dB Gain  
3 V, 80 mA @ 20 dB Gain
- **50 Ω Input/Output Matching**

#### Description

The HMMC-5038 MMIC is a high-gain low-noise amplifier (LNA) designed for communication receivers that operate from 37 GHz to 40 GHz. The gain of this four stage LNA can be adjusted by altering the gate bias of the output two, or three, stages while maintaining optimum noise figure bias for the input stage(s). Large FETs provide high power handling capability to avoid power compression. The backside of the chip is both RF and DC ground. This helps simplify the assembly process and reduce assembly related performance variations and costs.

The HMMC-5038 is fabricated using a PHEMT integrated circuit structure that provides good noise and gain performance.

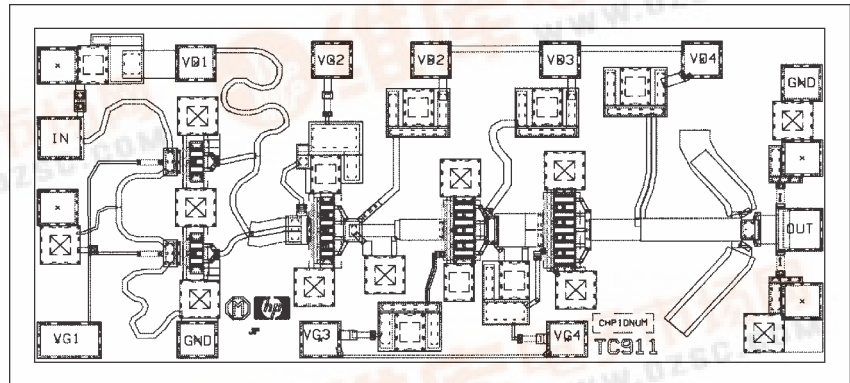

Chip Size: 1630 x 760 μm (64.2 x 29.9 mils)  
 Chip Size Tolerance: ± 10 μm (± 0.4 mils)  
 Chip Thickness: 127 ± 15 μm (5.0 ± 0.6 mils)  
 Pad Dimensions: 80 x 80 μm (3.1 x 3.1 mils)

#### Absolute Maximum Ratings<sup>[1]</sup>

Symbol	Parameters/Conditions	Units	Min.	Max.
V <sub>D1,2-3-4</sub>	Drain Supply Voltages	V		5
I <sub>G1,2-3-4</sub>	Gate Supply Voltages	V	-3.0	0
I <sub>DD</sub>	Total Drain Current	mA		300
P <sub>in</sub>	RF Input Power	dBm		15
T <sub>ch</sub>	Channel Temperature <sup>[2]</sup>	°C		+160
T <sub>A</sub>	Backside Ambient Temp.	°C	-55	+125
T <sub>STG</sub>	Storage Temperature	°C	-65	+165
T <sub>max</sub>	Maximum Assembly Temp.	°C		+310

#### Note:

1. Absolute maximum ratings for continuous operation unless otherwise noted.
2. Refer to DC Specifications/Physical Properties table for derating information.



## DC Specifications/Physical Properties<sup>[1]</sup>

Symbol	Parameters and Test Conditions	Units	Min.	Typ.	Max.
$V_{D1,2,3-4}$	Low Noise Drain Supply Operating Voltages	V	2	3	5
$I_{D1}$	First Stage Drain Supply Current ( $V_{DD} = 3\text{ V}$ , $V_{G1} = -0.8\text{ V}$ )	mA		22	
$I_{D2-3-4}$	Drain Supply Current for Stages 2, 3, and 4 Combined ( $V_{DD} = 3\text{ V}$ , $V_{GG} = -0.8\text{ V}$ )	mA		98	
$V_{G1,2,3-4}$	Gate Supply Operating Voltages ( $I_{DD} = 120\text{ mA}$ )	V		-0.8	
$V_p$	Pinch-off Voltage ( $V_{DD} = 3\text{ V}$ , $I_{DD} \leq 10\text{ mA}$ )	V	-2	-1.2	-0.8
$\theta_{ch-bs}$	Thermal Resistance <sup>[2]</sup> (Channel-to-Backside @ $T_{ch} = 160^\circ\text{C}$ )	$^\circ\text{C}/\text{W}$		62	
$T_{ch}$	Channel Temperature <sup>[3]</sup> ( $T_A = 125^\circ\text{C}$ , $\text{MTTF} > 10^6\text{ hrs}$ , $V_{DD} = 3\text{ V}$ , $I_{DD} = 120\text{ mA}$ )	$^\circ\text{C}$		150	

### Notes:

- Backside ambient operating temperature  $T_A = 25^\circ\text{C}$  unless otherwise noted.
- Thermal resistance ( $^\circ\text{C}/\text{Watt}$ ) at a channel temperature  $T$  ( $^\circ\text{C}$ ) can be *estimated* using the equation:  

$$\theta(T) \cong 62 \times [T(^\circ\text{C}) + 273] / [160^\circ\text{C} + 273].$$
- Derate MTTF by a factor of two for every  $8^\circ\text{C}$  above  $T_{ch}$ .

## RF Specifications, $T_A = 25^\circ\text{C}$ , $V_{DD} = 3\text{ V}$ , $I_{DD} = 120\text{ mA}$ , $Z_o = 50\ \Omega$

Symbol	Parameters and Test Conditions	Units	Min.	Typ.	Max.
BW	Operating Bandwidth	GHz	37		40
$S_{21}$	Small Signal Gain <sup>[1]</sup>	dB	20	23	
$\Delta S_{21}$	Small Signal Gain Flatness	dB		$\pm 0.5$	
$(RL_{in})_{MIN}$	Minimum Input Return Loss w/o external capacitive matching <sup>[2]</sup>	dB	8	12	
$(RL_{out})_{MIN}$	Minimum Output Return Loss	dB	12	18	
$S_{12}$	Reverse Isolation	dB		50	
$P_{-1dB}$	Output Power @ 1dB Gain Compression	dBm		12	
NF	Noise Figure <sup>[3]</sup>	dB		4.8	

### Notes:

- Gain may be reduced by biasing for lower  $I_{DD}$ . Increasing  $I_{DD}$  will increase Gain.
- Minimum input return may be improved by approximately 3 dB by including a small capacitive ( $\sim 30\text{ fF}$ ) stub on the input transmission line.
- Noise Figure may be further reduced by optimizing DC bias conditions.

## Applications

The HMMC-5038 low noise amplifier (LNA) is designed for use in digital radio communication systems and point-to-multipoint links that operate within the 37 GHz to 40 GHz frequency band. High gain and low noise temperature make it ideally suited as a front-end gain stage in the receiver. The MMIC solution is a cost effective alternative to hybrid assemblies.

## Biassing and Operation

The recommended DC bias condition is with all drains connected to single 3 volt supply and all gates connected to an adjustable negative voltage supply as shown in Figure 1(a). The gate voltage is adjusted for a total drain supply current of typically 120 mA. Reducing the current in stages 3 and 4 will reduce the overall gain. The gain can be adjusted further by altering the current through stage 2 with little affect on noise figure. Optimum noise figure is realized with  $V_{D1} = 3$  to 4 volts and  $I_{D1} = 20$  to 25 mA.

The second, third, and fourth stage DC drain bias lines are connected internally and therefore require only a single bond wire. An additional bond wire is needed for the first stage DC drain bias,  $V_{D1}$ .

The third and fourth stage DC gate bias lines are connected internally. A total of three DC gate bond wires are required: One for  $V_{G1}$ , one for  $V_{G2}$ , and one for the  $V_{G3}$ -to- $V_{G4}$  connection as shown in Figure 1.

A DC blocking capacitor is needed in the RF input transmission line only if there is DC voltage present. The RF output is AC-coupled.

Optimum input match is achieved when an optional capacitive ( $\sim 30$  fF) stub is included on the input transmission line. This capacitance compliments the bond wire inductance to complete the input matching network. No ground wires are needed because ground connections are made with plated through-holes to the backside of the device.

## Assembly Techniques

A conductive epoxy such as ABLEBOND<sup>®</sup> 71-1LM1 or ABLEBOND<sup>®</sup> 84-1LM1 is the recommended assembly method provided the Absolute Maximum Thermal Ratings are not exceeded. Solder die attach using a fluxless gold-tin (AuSn) solder preform may also be used. The device should be attached to an electrically conductive surface to complete the DC and RF ground paths. The backside metallization on the device is gold.

It is recommended that the RF input and RF output connections be made using either 500 line/inch (or equivalent) gold wire mesh, or dual 0.7 mil diameter gold wire. The RF wires should be kept as short as possible to minimize inductance. The bias supply can be 0.7 mil diameter gold wires.

Thermosonic wedge is the preferred method for wire bonding to the gold bond pads. Mesh wires can be attached using a 2 mil round tacking tool and a tool force of approximately 22 grams with an ultrasonic power of roughly 55 dB for a duration of  $76 \pm 8$  msec. A guided-wedge at an ultrasonic power level of 64 dB can be used for the 0.7 mil wire. The recommended wire bond stage temperature is  $150 \pm 2^\circ\text{C}$ .

For more detailed information see HP application note #999 "GaAs MMIC Assembly and Handling Guidelines."

---

*GaAs MMICs are ESD sensitive. Proper precautions should be used when handling these devices.*

---

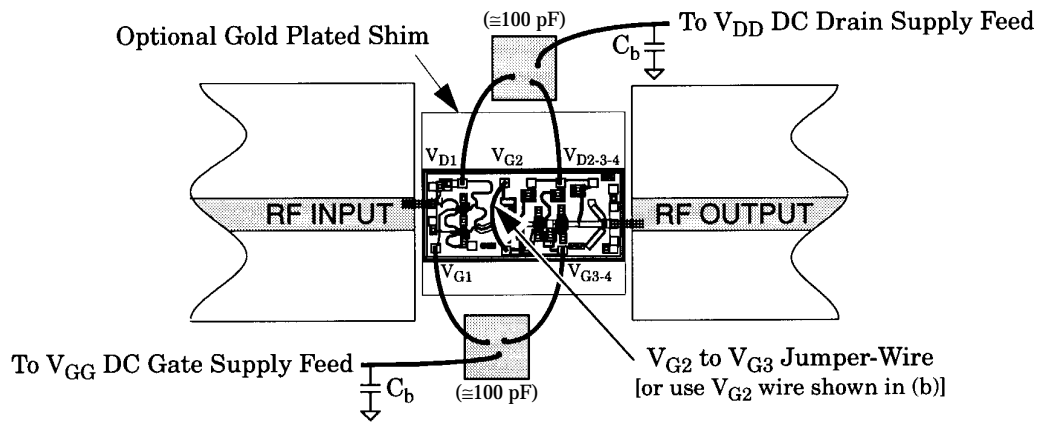

(a) Single drain-supply and single gate-supply assembly.

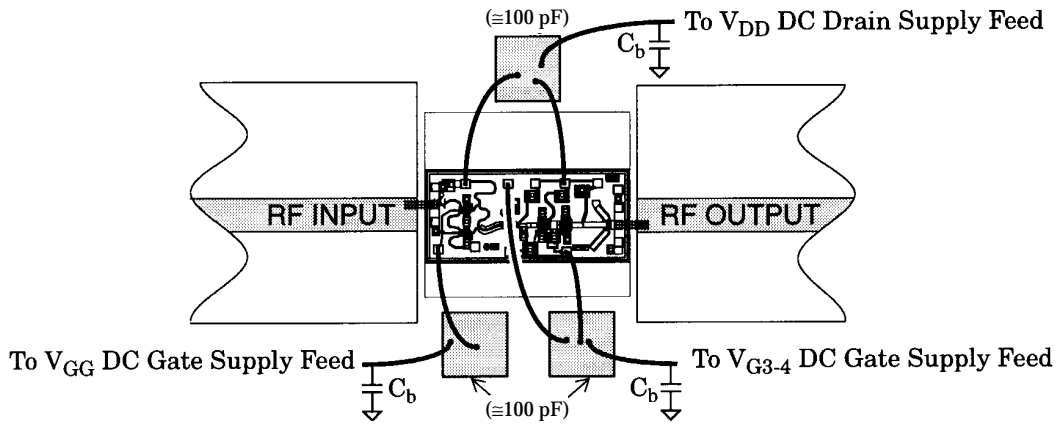

(b) Separate first-stage gate bias supply.

This diagram shows an optional variation to the  $V_{G2}$  jumper-wire bonding scheme presented in (a).

**Figure 1. HMMC-5038 Common Assembly Diagrams.**

(Note: To assure stable operation, bias supply feeds should be bypassed to ground with a capacitor,  $C_b > 100$  nF typical.)

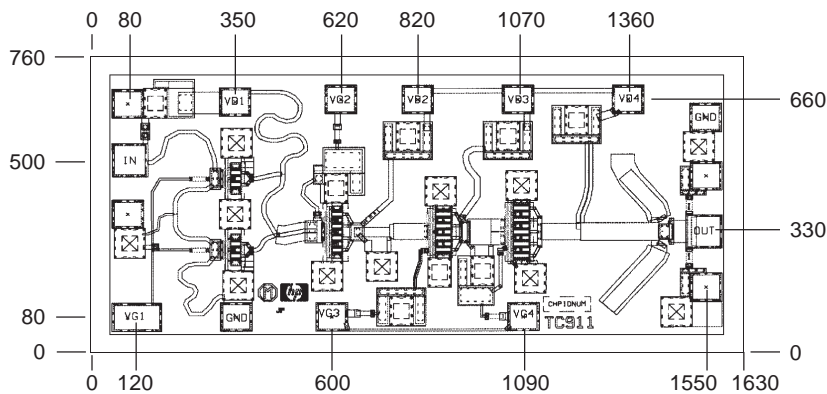

**Figure 2. HMMC-5038 Bonding Pad Locations.** (Dimensions in micrometers)

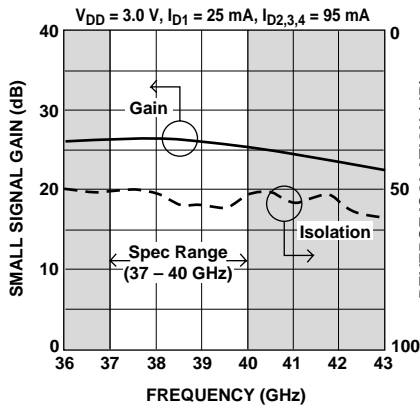

Figure 3. Gain and Isolation vs. Frequency.

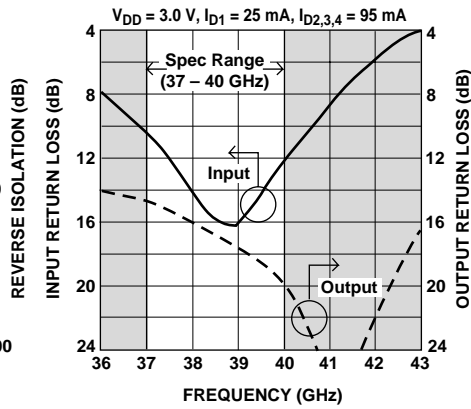

Figure 4. Input and Output Return Loss vs. Frequency.

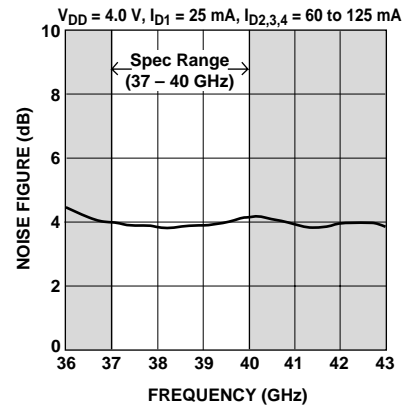

Figure 5. Noise Figure vs. Frequency.

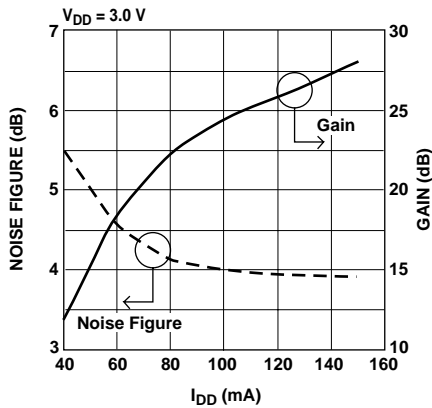

Figure 6. 38 GHz Noise Figure and Gain vs.  $I_{DD}$ .

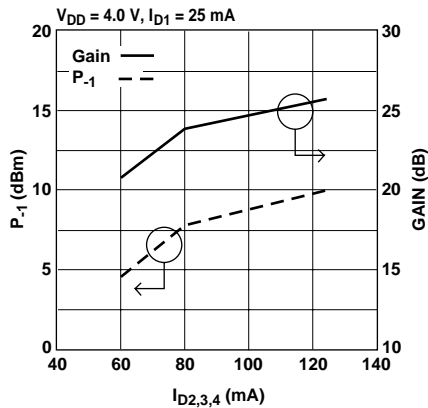

Figure 7. 38 GHz Gain and Power Performance vs.  $I_{D2,3,4}$ .