



Fast Settling Video Operational Amplifier

HOS-050, 050A, 050C

FEATURES

- 80ns Settling to 0.1%; 200ns to 0.01%
- 100MHz Gain Bandwidth Product
- 55MHz 3dB Bandwidth
- 100mA Output @ $\pm 10V$

APPLICATIONS

- D/A Current Converter
- Video Pulse Amplifier
- CRT Deflection Amplifier
- Wideband Current Booster

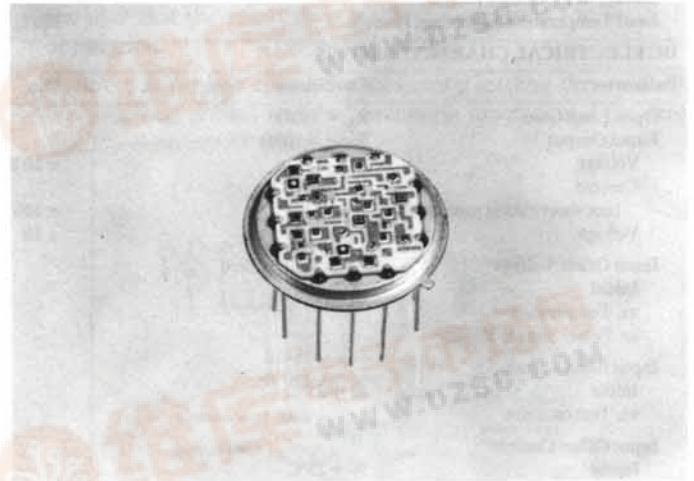

GENERAL DESCRIPTION

The HOS-050, HOS-050A, and HOS-050C op amps are very high speed wideband operational amplifiers designed to complement the Analog Devices' lines of high speed data acquisition products. They feature a 100MHz gain bandwidth product; slew rate of 300V/ μ s; and settling time of 80ns to $\pm 0.1\%$.

The HOS-050A, HOS-050, and HOS-050C have typical input offset voltages of 10mV, 25mV, and 45mV, respectively.

All models have a rated output of $\pm 100mA$ minimum, and an exceptional noise spec of only 7 μ V rms, dc to 2MHz; they are ideally suited for a broad range of video applications.

FAST-SETTLING OP AMPS

At one time, operational amplifiers could be specified according to slew rates, bandwidth, and drive capability; and these parameters would be sufficient. Settling time was not considered until the use of high speed video D/A converters became widespread.

The conversion speed of the D/A can be limited by the settling time of the output amplifier, so it has become essential to select an op amp whose settling time is compatible with the D/A converter.

The increased emphasis on settling time has, in some cases, created a preoccupation with slew rates in the minds of some designers. But slew rate is only one component in establishing settling time.

The amount of overshoot, and the ringing which are present at the end of a step function change also have an effect. These parameters, in turn, are influenced by the bandwidth (or lack of it) when operating the op amp with closed loop gains greater than one.

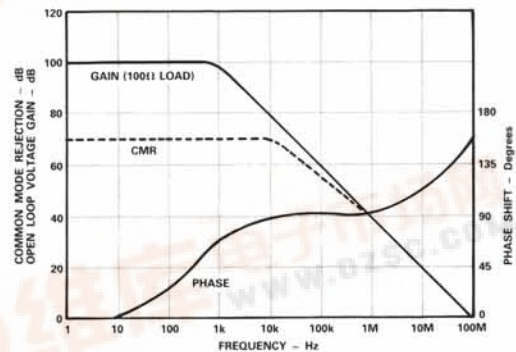

Figure 1. HOS-050 Frequency Response

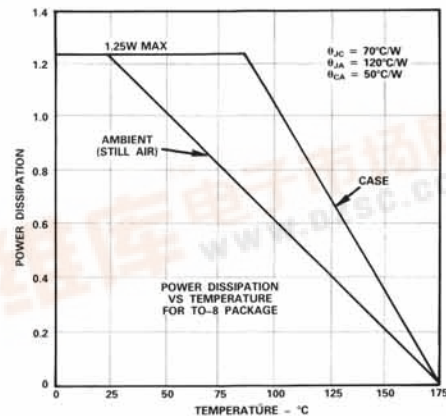

Figure 2. Power Dissipation vs. Temperature



SPECIFICATIONS (typical @ +25°C and ±15V unless otherwise specified)

Model	HOS-050	HOS-050A	HOS-050C
ABSOLUTE MAXIMUM RATINGS			
Supply Voltages (V_S)	±18V	*	*
Power Dissipation	See Figure 2	*	*
Input Voltage	± V_S	*	*
Differential Input Voltage	± V_S	*	*
Operating Temperature Range (case)	-55°C to +125°C	*	-25°C to +85°C
Junction Temperature	175°C	*	*
Storage Temperature Range	-65°C to +150°C	*	*
Lead Temperature (soldering, 10 sec.)	300°C	*	*

DC ELECTRICAL CHARACTERISTICS

Parameter	Conditions	Min	Typ	Max	Min	Typ	Max	Min	Typ	Max	Units
Open Loop Gain	$R_L = 100\Omega$		100			*			*		dB
Rated Output Voltage	$R_L = >100\Omega$										V
Current (not short circuit protected)			±10/8		*			*			mA
Input Offset Voltage	$R_L = >200\Omega$		±10		*			*			V
Initial vs. Temperature	Adjustable to Zero @ +25°C		25	35	10	15		45	65		mV
vs. Power Supply Voltage			50	150	20	35		75	200		$\mu\text{V}/^\circ\text{C}$
Input Bias Current	@ +25°C		1	2	*	*		*	*		nA
Initial vs. Temperature			Doubles		*	*		*	*		/10°C
Input Offset Current	@ +25°C		±100		*			*			nA
Input Impedance	}In parallel with 5pF		10 ¹⁰		*			*			Ω
Differential Common Mode			10 ¹⁰		*			*			Ω
Input Voltage Range			±10		*		*	*		*	V
Common Mode				±18			*			*	V
Differential				±18			*			*	V
Common Mode Rejection			70		*			*			dB
Input Noise	$R_{FF} = 100\Omega$; $R_{FB} = 1k\Omega$		5		*			*			$\mu\text{V rms}$
dc to 100kHz			7		*			*			$\mu\text{V rms}$
dc to 2MHz					*			*			$\mu\text{V rms}$

AC ELECTRICAL CHARACTERISTICS¹

Parameter	Conditions	Min	Typ	Max	Min	Typ	Max	Min	Typ	Max	Units
Slew Rate	$A = -1$; $R_{FF} = R_{FB} = 500\Omega$; Load = 100 Ω		300			*			*		V/ μs
Noninverting Slew Rate	$A = 2$; $R_{FF} = R_{FB} = 1000\Omega$; Load = 100 Ω		320			*			*		V/ μs
Overload Recovery	50% Overdrive		400			*			*		ns
Gain Bandwidth Product	$R_{FF} = R_{FB} = 500\Omega$		100			*			*		MHz
Small Signal Bandwidth, -3dB	$A = -1$; $R_{FF} = R_{FB} = 500\Omega$		45			*			*		MHz
	$A = -1$; $R_{FF} = R_{FB} = 1000\Omega$		35			*			*		MHz
	$A = -2$; $R_{FF} = R_{FB} = 500\Omega$; $R_{FB} = 1000\Omega$		35			*			*		MHz
	$A = -4$; $R_{FF} = R_{FB} = 250\Omega$; $R_{FB} = 1000\Omega$		30			*			*		MHz
Output Impedance				<1			*			*	Ω
Noninverting Bandwidth, -3dB	$A = 2$; $R_{FF} = R_{FB} = 1000\Omega$; 100 Ω load; 10pF capacitance		25			*			*		MHz
	5-volt p-p output		30			*			*		MHz
	4-volt p-p output		55			*			*		MHz
	2-volt p-p output					*			*		MHz
	$A = 3$; $R_{FF} = 500\Omega$; $R_{FB} = 1000\Omega$; 100 Ω , 1000 Ω ; or 2000 Ω load; 10pF capacitance		17			*			*		MHz
	10-volt p-p output		25			*			*		MHz
	5-volt p-p output					*			*		MHz

AC ELECTRICAL CHARACTERISTICS¹ (Continued)

Parameter	Conditions	HOS-050			HOS050A			HOS-050C			Units
		Min	Typ	Max	Min	Typ	Max	Min	Typ	Max	
Noninverting Bandwidth, -3dB (continued)	A = 5; R _{FF} = 500Ω; R _{FB} = 2000Ω; 100Ω, 1000Ω, or 2000Ωload/10pF capacitance										
	5-volt p-p output		15			*			*		MHz
	4-volt p-p output		30			*			*		MHz
	2-volt p-p output		40			*			*		MHz
	1-volt p-p output		40			*			*		MHz
Full Power Bandwidth	Output = +10V/-8V @ ±100mA; 5% distortion		5			*			*		MHz
Settling Time to 0.1% Inverting (See Figure 5)	A = -1; R _{FF} = R _{FB} = 500Ω V _{OUT} = ±5V										
	V _{OUT} = ±2.5V										
	A = 2; R _{FF} = R _{FB} = 500Ω Max Load capacitance = 75pF		200			*			*		ns
Noninverting Distortion (See Figure 10)	V _{OUT} = ±2.5V		135			*			*		ns
	A = -1; Load = 1000Ω Signal = 4MHz; 2V output		-63			*			*		dB
Harmonic Distortion (See Figure 9)	A = 2; R _{FF} = R _{FB} = 1000Ω; Load = 1000Ω; Signal = 4MHz; 2V output		-59			*			*		dB
Power Supply	Rated performance		±15			*			*		V dc
	Operating range	±12		±18	*		*	*		*	V dc
	Quiescent		±20	±25		*	*		*	*	mA
	Power Consumption		0.6			*			*		W
	Power Dissipation			1.25			*			*	
Temperature Range	(See Figure 2 for Derating Information)										
	Operating (Case)	-55		+125	*		*	-25		+85	°C
Storage		-65		+150	*		*	*		*	°C
Meantime Between Failures (MTBF)	MIL-HNBK 217; Ground; Fixed; Case = 70°C 883B Processing	2.78 × 10 ⁶			*			*			Hours

Notes:

¹Specification for Inverting Mode unless otherwise noted.
*Specification same as HOS-050

Individual socket assemblies (one per pin) are available from AMP as part number 6-330808-0.
Specifications subject to change without notice.

OUTLINE DIMENSIONS

Dimensions shown in inches and (mm).

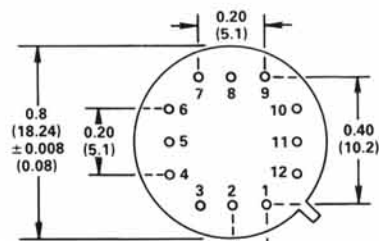
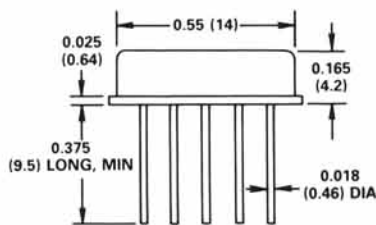

TO-8 CAN
PINS ARE GOLD PLATED

BOTTOM VIEW

PIN DESIGNATIONS

PINS	FUNCTION
1	+V
2	GROUND
3	OFFSET ADJ* OFFSET ADJ*
4	-V
5	+INPUT
6	-INPUT
7	NC
8	GROUND
9	-V
10	+V
11	OUTPUT
12	+V

*PINS FOR CONNECTING OPTIONAL
OFFSET POTENTIOMETER.

**HOS-050/A/C
OUTLINE AND PIN DESIGNATIONS**

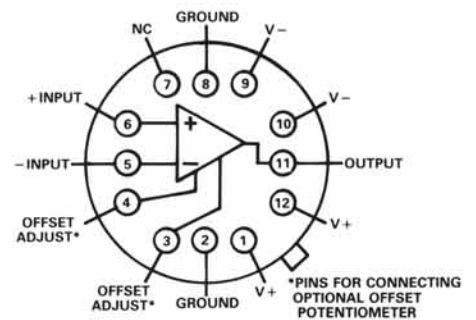

TO-8 PACKAGE
BOTTOM VIEW

The HOS-050 Series stands up under close scrutiny of these characteristics because of its 100MHz gain bandwidth product. The use of these amplifiers in a wide variety of applications has confirmed their suitability for video circuits.

The HOS-050 is also available with MIL-883 processing. Model numbers change from HOS-050 to HOS-050B; and HOS-050A to HOS-050AB.

VOLTAGE AMPLIFIERS/CURRENT BOOSTERS

Video op amps such as the HOS-050 are generally characterized by high gain bandwidth products, fast settling times, and high output drive.

One of the most common uses of video op amps is for D/A converter output voltage amplification or current boosting.

Figure 3 is one example of this type of application. In this circuit, the internal resistance of the D/A is the feed forward resistor for the op amp.

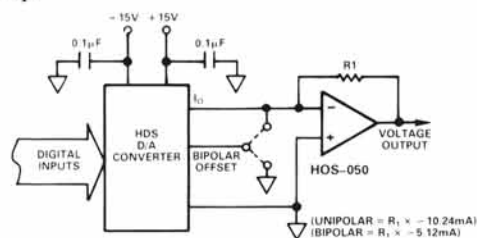

Figure 3. Inverting Unipolar or Bipolar Voltage Output

The HDS Series D/A converters are fast-settling, current output D/As available in 8-, 10-, and 12-bit resolutions. Both TTL and ECL versions are available, and settling times range from 10ns for 8-bit units through 40ns for 12-bit units.

The circuit which is shown will provide a negative unipolar output with binary coding on the input, and bipolar offset grounded. It will provide a bipolar output with complementary offset binary coding on the input, and bipolar offset connected to I_O .

An approximation of the total settling time for the D/A op amp combination is calculated by:

$$T_s = \sqrt{T_D^2 + T_O^2}$$

where T_D is D/A settling time and T_O is HOS-050 settling time.

This approximation is valid because both the D/A and the HOS-050 exhibit 6dB/octave roll-off characteristics (single pole response); and the combination of low D/A output capacitance and op amp input capacitance does not materially affect the formula.

The user of the HOS-050 should remember the current flowing in the feedback resistor (R_1) must be subtracted from the output available from the HOS-050.

There is a tendency, because of this fact, to use a high value of feedback resistor to assure maximum current drive being available for driving low impedances; but this approach may create undesirable side effects.

Calculating the minimum load that can be driven under two conditions of feedback resistor values will serve to illustrate the difference.

Assume the feedback resistor value is 500Ω. If output voltage of the HOS-050 is 10 volts, and output current is 100mA, minimum load would be:

$$\frac{E_O \text{ max}}{I_O \text{ max} - I_{RFB}} = \frac{10V}{100mA - 20mA} = \frac{10V}{80mA} = 125\Omega \text{ minimum load}$$

where: $E_O \text{ max}$ = peak voltage needed

$I_O \text{ max}$ = maximum continuous current HOS-050 can produce

I_{RFB} = current in feedback resistor at peak voltage

Assume the feedback resistor value is 5,000Ω. Minimum load would be:

$$\frac{E_O \text{ max}}{I_O \text{ max} - I_{RFB}} = \frac{10V}{100mA - 2mA} = \frac{10V}{98mA} = 102\Omega \text{ minimum load}$$

Designs which strive for driving a minimum load (by increasing the feedback resistor) can create settling problems because of a fundamental characteristic of op amp circuits . . . the higher the feedback resistance, the slower the system response.

This phenomenon is the result of increased impedance for driving stray capacitances in the circuit employing the op amp, and fixed capacitances in the summing node.

Impedances need to be kept as low as possible consistent with low distortion; and stray capacitances need to be eliminated to the maximum possible extent. A large ground plane structure is recommended to help assure low ground impedances. In addition, 0.1µF ceramic capacitors and 3-10µF tantalum capacitors connected as close as possible to power supply inputs will decrease the potential for parasitic oscillations and other noise signals.

Another argument for limiting the size of the feedback resistor is because of its effect on bandwidth. Bandwidth of the HOS-050 op amp and the value of the feedback resistor are inversely related.

At any given gain of the op amp, the gain setting with the widest bandwidth will be the one which employs the lower value of feedback. As an example, a gain of 1 can be achieved with $R_{FF} = R_{FB} = 500\Omega$; or $R_{FF} = R_{FB} = 1,000\Omega$. Small-signal bandwidth for the first combination is typically 45MHz; bandwidth for the second is typically 35MHz.

OFFSET AND GAIN ADJUSTMENT

Figure 4 shows a method of using the HOS-050 op amp which allows adjusting the offset and gain of the output voltage.

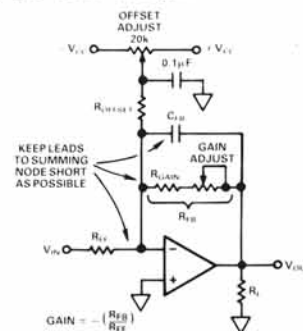

Figure 4. HOS-050 Offset and Gain Adjust

As shown, the gain of the circuit is established by the equation:

$$G = - \left(\frac{R_{FB}}{R_{FF}} \right)$$

where R_{FB} is the total of R_{GAIN} and Gain Adjust.

Once the user has established the desired gain for the illustrated circuit, the value of R_{FB} can be used to determine the correct value of R_{OFFSET} with the equation:

$$R_{OFFSET} = - \left(\frac{V_{CC} \times R_{FB}}{\Delta E_O} \right)$$

where ΔE_O is the desired amount of offset on the output.

Assume $\pm V_{CC} = \pm 15V$; $R_{GAIN} = 900\Omega$; Gain Adjust = 100 Ω ; the desired change on the output = ± 1 volt.

Under these conditions, R_{OFFSET} will be 15k Ω :

$$R_{OFFSET} = - \left(\frac{15V \times [900 + 100]}{1V} \right)$$

$$R_{OFFSET} = - \left(\frac{15kV}{1V} \right)$$

$$R_{OFFSET} = 15,000\Omega$$

Figure 4 shows bipolar output operation. If unipolar output is desired, the appropriate V_{CC} should be removed from the Offset Adjust potentiometer.

The 0.1 μ F capacitor attached to the wiper arm of the Offset Adjust control isolates the control and helps prevent adjustment noise from appearing on the output of the HOS-050.

C_{FB} can be any value between 0 and 20pF, depending on the value of R_{GAIN} ; and should be selected to optimize settling time for the particular circuit layout in which the HOS-050 is being used.

The Gain Adjust control should be a low value, low inductance cermet trimming potentiometer.

Note: R_{FF} , R_{GAIN} , C_{FB} and R_{OFFSET} must be located as close to the summing node of the HOS-050 as physically possible. This helps prevent additional capacitance in the summing node and corresponding bad effects on frequency response and settling times.

Variable controls (such as Offset Adjust and Gain Adjust) should never be tied to the summing node of the op amp. Their correct electrical locations are those shown in Figure 4.

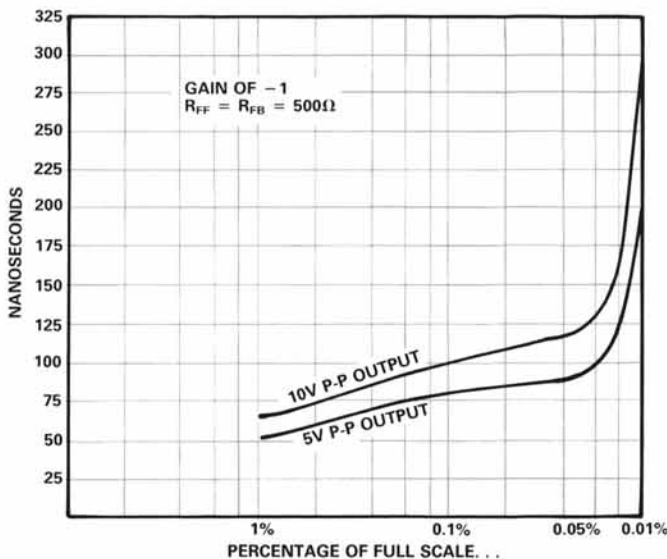

Figure 5. Settling Time - Inverting Mode

SETTLING TIME MEASUREMENT

Although there are some exceptions, most members of industry are in agreement on the description which says settling time is:

The interval of time from the application of an ideal step function input until the closed-loop amplifier output has entered and remains within a specified error band.

The well-informed user needs to be alert to the consequences of settling time specs which do not meet that description.

This definition encompasses the major components which comprise

settling time. They include (1) propagation delay through the amplifier; (2) slewing time to approach the final output value; (3) the time of recovery from the overload associated with slewing; and (4) linear settling to within the specified error band.

Expressed in these terms, the measurement of settling time is obviously a challenge and needs to be done accurately to assure the user that the amplifier is worth consideration for his application.

Figure 6 is the test circuit for measuring settling time to 0.1%. This method creates a "false" summing junction and the error band is observed at that point.

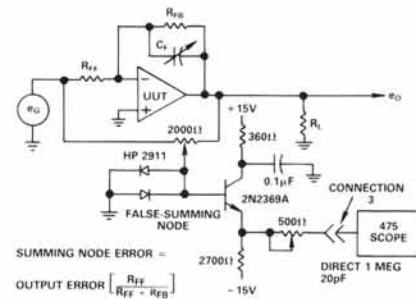

Figure 6. Settling Time Test Circuit for 0.1% Settling

If one were to attempt the measurement at the "true" summing junction of the op amp, the results would be misleading. All scope probes will add capacitance to the input and will change the response of the system. Making the measurement at the output of the amplifier is also impractical, since scope nonlinearities and reading inaccuracies caused by overdriving the scope preclude accurate measurements to the tolerances which are required.

The false summing junction method causes the amplifier to subtract the output from the input; only one-half the actual error appears at the false junction, and it can be measured to the required accuracies.

The false junction is clamped with diodes to limit the voltage excursion appearing at that point. This is necessary because the amplifier will be overdriven and one-half its input voltage will appear at the junction. Without the clamps, the scope used for making the measurement would be overdriven and its recovery time would mask the settling time of the amplifier.

The test circuit for measuring settling time to 0.01%, Figure 7, is simply an extension of the same basic technique. Measuring to the closer tolerance requires additional gain in the circuit driving the oscilloscope.

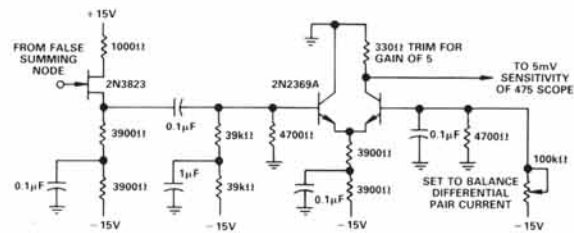

Figure 7. Settling Time Test Circuit for 0.01% Settling

IMPEDANCE MATCHING

The characteristics of the HOS-050 operational amplifier make it an ideal choice for matching the impedances of video circuits to the impedances of transmission lines.

In this application, source and load terminating resistors will cause the output voltage to be halved at the end of the cable

being driven by the op amp. This makes it necessary to set the gain of the circuit to provide twice the desired voltage.

Three different values of resistors and cables are "phantomed" into the figure as examples of possible characteristic impedances which might be used. Figure 8 is *not* meant to imply the HOS-050 can drive three cables simultaneously.

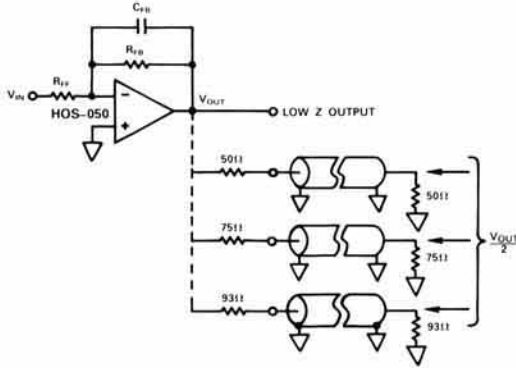

Figure 8. HOS-050 Impedance Matching

NONINVERTING OPERATION

The vast majority of video operational amplifiers display marked differences in settling times and bandwidths when operated in a noninverting mode instead of the inverting mode. There are a number of valid reasons for this characteristic.

Most high-speed op amps use feed-forward compensation for optimizing performance in the inverting mode. This is necessary to obtain wide gain-bandwidth products while maintaining dc performance in these types of devices. In effect, the op amp has a wideband ac channel which is not perfectly matched to the dc channel.

Feed-forward techniques enhance the performance of the op amp in the inverting mode by increasing the slew rate and small-signal bandwidth. These techniques, however, also decrease the amplifier's tolerance to stray capacitances, so must be employed judiciously.

The overall input capacitance of the op amp is kept as low as possible in the design; and any mismatch in the capacitance of the two channels appears as an error in the output. Because of the inherently low total input capacitance of the op amp, even a small capacitive mismatch between channels shows up as a large effective error signal.

Decreasing the channel mismatch can be achieved only by complicating the design of the op amp with additional components, and rigorous selection of those components in the manufacturing process.

As a consequence, the mismatch is reduced to the smallest practical value consistent with the economics of producing and using the op amp. But it remains a mismatch, and manifests itself as a difference in performance in the inverting versus noninverting modes.

There are video op amps available at low cost which use a 741-type amplifier for high dc open loop gain in the noninverting channel. The user of these kinds of designs may sometimes gain an economic advantage, but at a high cost in performance. Bandwidths for noninverting applications are often measured in kHz, not MHz, for this approach.

A video op amp is acting as a voltage mode device at both inputs when operating in the noninverting mode. This contrasts with the inverting mode, where it is operating as a current mode device.

The Analog Devices HOS-050 has different performance characteristics when operating as a noninverting amplifier, but the care used in the design makes the differences less pronounced than they are in many competing units.

The HOS-050 can be considered a true differential video op amp. It requires little or no external compensation because its rolloff characteristics approach a 6dB/octave slope. This helps the user determine summing errors and loop response; and helps assure the stability of the system.

The performance parameters for both inverting and noninverting operation are shown elsewhere in this data sheet (see SPECIFICATIONS section and figures). A comparison of the characteristics will highlight the similarities in performance, with the exceptions noted above.

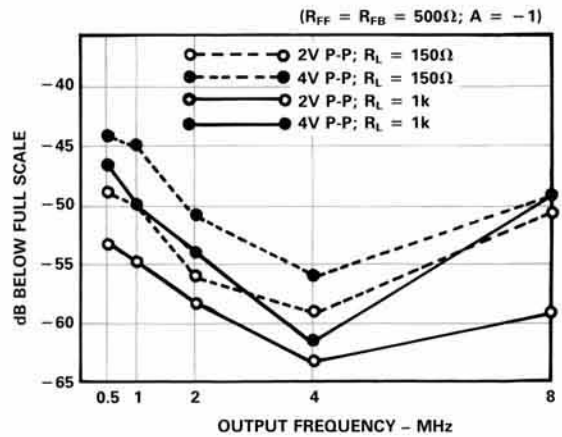

Figure 9. Harmonic Distortion - Inverting

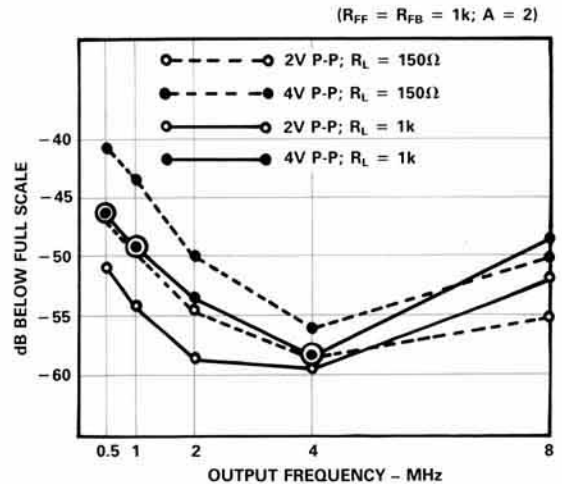

Figure 10. Harmonic Distortion - Noninverting

IN SUMMARY . . . A CAVEAT

Settling time specifications, bandwidth capabilities, harmonic distortion performance, and other parameters for video op amps cannot possibly include all possible situations and applications.

A multitude of seemingly insignificant conditions can have a major impact on the unit and its ability to operate in any given circuit.

The potential user is strongly urged to evaluate the effectiveness of the HOS-050 in the actual circuit in which it will be used. In many instances, the application conditions are different from the conditions used in specifying; there is no substitute for a trial in the proposed circuit to determine if the op amp will provide the desired results.