

PIN Photodiode

KODENSHI

HPI - 23G

The HPI - 23G is a high - speed, high - output silicon PIN photodiode mounted in a clear sidelooking package. The photodiode is small size, low profile and easy mounting.

FEATURES

- High - output power
- High - speed response
- Wide angular response
- Low - cost
- Sidelooking plastic package

APPLICATIONS

- Fiber optic communications
- Optical switches
- Photocoupler

DIMENSIONS

(Unit : mm)

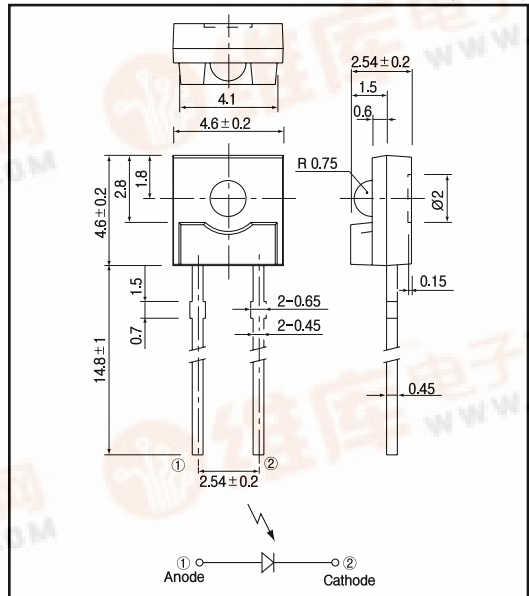

MAXIMUM RATINGS

(Ta=25)

Item	Symbol	Rating	Unit
Reverse voltage	V _R	40	V
Operating temp.	T _{opr.}	- 20 ~ +85	
Storage temp.	T _{stg.}	- 30 ~ +100	
Soldering temp. *1	T _{sol.}	260	

*1.For MAX.5 seconds at the position of 2 mm from the package

ELECTRO-OPTICAL CHARACTERISTICS

(Ta=25)

Item	Symbol	Conditions	Min.	Typ.	Max.	Unit.
Open circuit voltage	V _{oc}	E _v = 1,000lx *2		0.4		V
Short circuit current	I _{sc}		10	16		μA
Sensitivity	S			0.4		A/W
Dark current	I _d	V _R = 10V			10	nA
Curve factor	C.F.		0.55			-
Capacitance	C _t	V = 0V, f = 1MHz		10		pF
Temperature coefficient of V _{oc}	t			- 2.2		mV/
Temperature coefficient of I _{sc}	t			0.18		%/
Spectral sensitivity				450 ~ 1,050		nm
Peak wavelength	p			920		nm
Half angle				± 30		deg.

*2. Color temp. = 2856K standard Tungsten lamp



PIN Photodiode

HPI - 23G

Light current Vs. Forward voltage

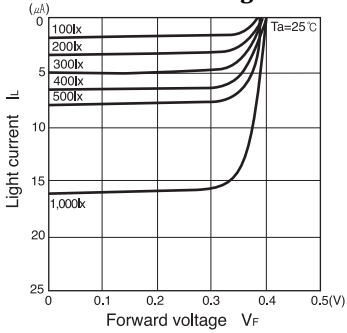

Short circuit current Vs. Illuminance

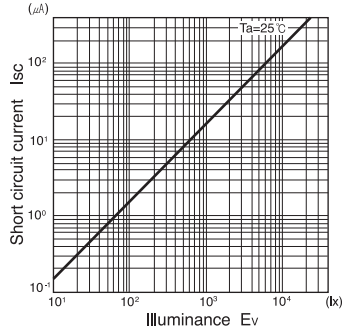

Dark current Vs. Ambient temperature

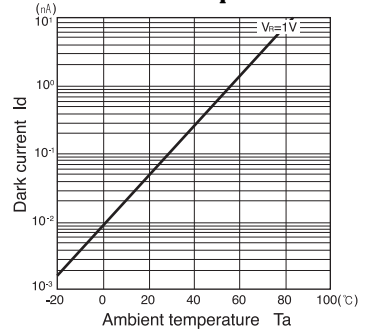

Relative sensitivity Vs. Wavelength

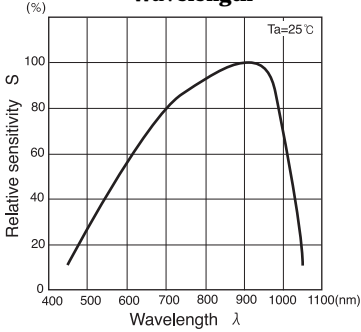

Dark current Vs. Reverse voltage

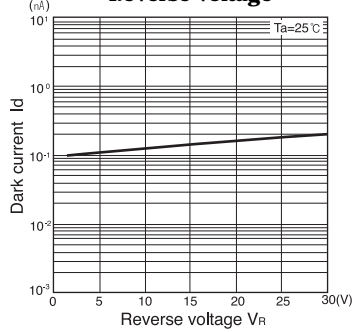

Radiant Pattern

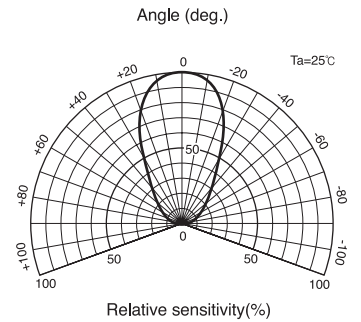

Capacitance between terminals Vs. Reverse voltage

