

# Surface Mount Chip LEDs

## Technical Data

### HSMB-C190/C170/ C110/C150

#### Features

- Small Size
- Industry Standard Footprint
- Compatible with IR Solder
- Diffused Optics
- Operating Temperature Range of -30°C to +85°C
- Right Angle Package Available
- SiC Blue Color
- Available in 8 mm tape on 7" (178 mm) Diameter Reels

#### Applications

- Keypad Backlighting
- Push-Button Backlighting
- LCD Backlighting
- Symbol Backlighting
- Front Panel Indicator

#### Description

These Blue chip LEDs are designed in an industry standard package for ease of handling and use. Blue color chip LED is a new product that offers color differentiation for backlighting applications.

The HSMB-C150 has the industry standard 3.2 x 1.6 mm footprint that is excellent for all around use. The HSMB-C170 has the widely used 2.0 x 1.25 mm footprint. The HSMB-C190 has the industry standard 1.6 x 0.8 mm footprint, its low 0.8 mm profile and wide viewing angle make this LED exceptional for backlighting applications.

The HSMB-C110 is a right-angle package with the universally accepted dimensions of 3.2 x 1.0



x 1.5 mm. This part is ideal for LCD backlighting and sidelighting applications.

All packages are compatible with IR reflow solder processes. The small size and wide viewing angle make these LEDs prime choices for backlighting applications and front panel illumination especially where space is a premium.

#### Device Selection Guide

Footprint (mm)	SiC Blue	Parts Per Reel
2.00 x 1.25	HSMB-C170	4000
1.60 x 0.80	HSMB-C190	4000
3.20 x 1.00 <sup>[1]</sup>	HSMB-C110	3000
3.20 x 1.60	HSMB-C150	3000

Note:  
1. Right-angle package.

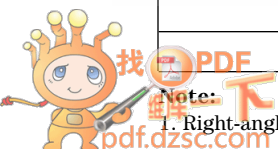

### Package Dimensions

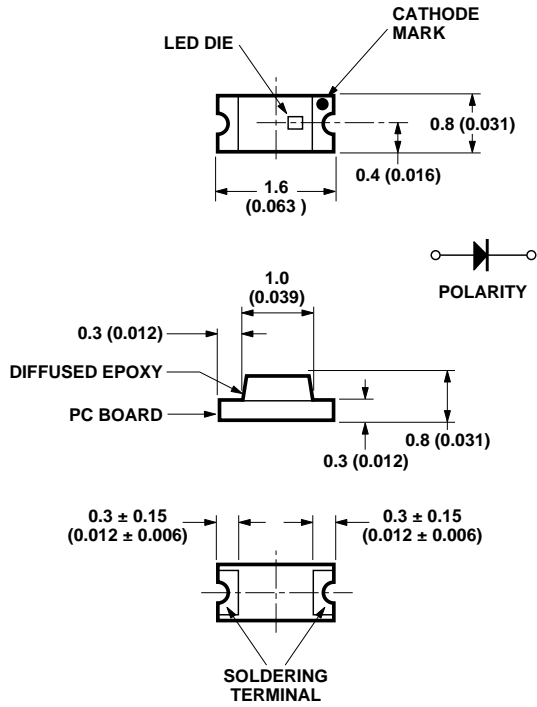

**HSMB-C190**

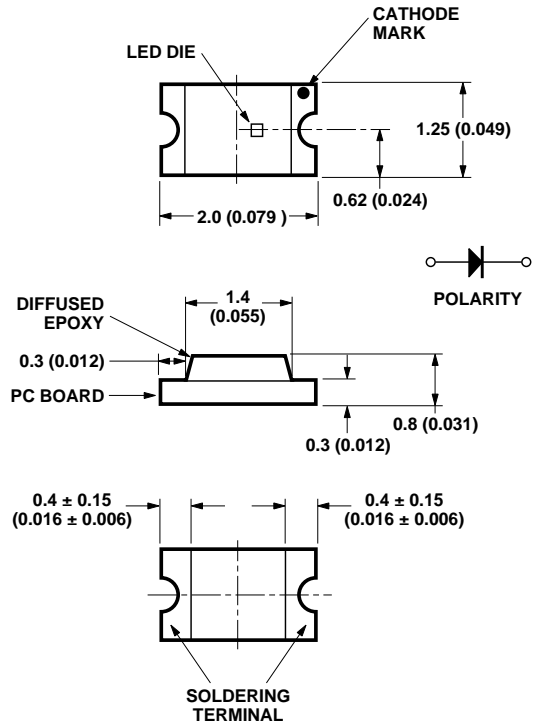

**HSMB-C170**

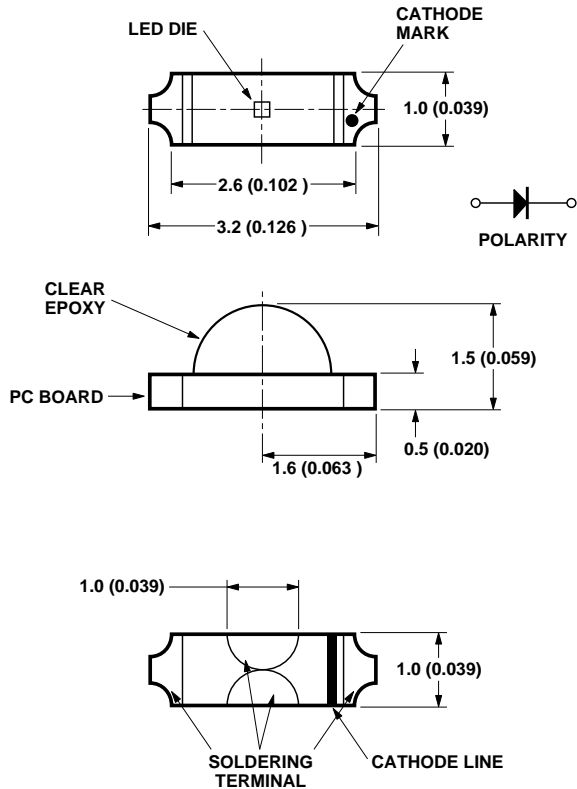

**HSMB-C110**

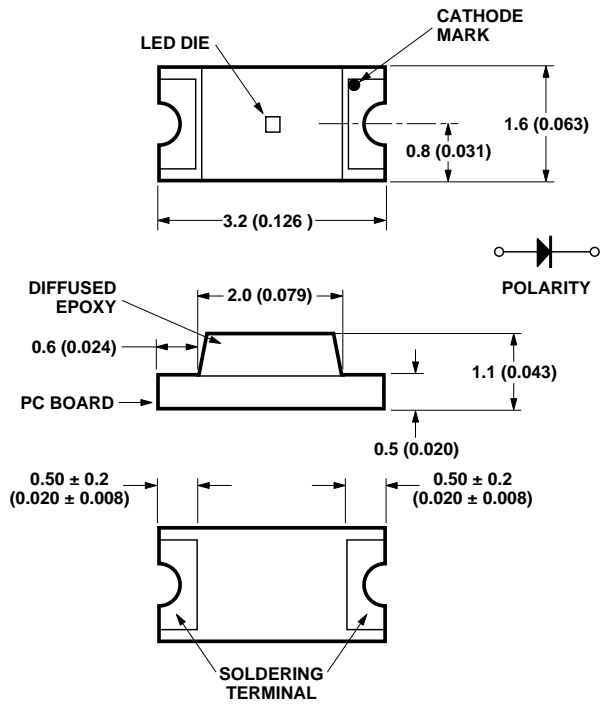

**HSMB-C150**

NOTE:  
1. ALL DIMENSIONS IN MILLIMETERS (INCHES).  
2. TOLERANCE IS ± 0.1 mm (± 0.004 IN.) UNLESS OTHERWISE SPECIFIED.

### Absolute Maximum Ratings at $T_A=25^\circ\text{C}$

Parameter	HSMB-C190/C170/C110/C150	Units
DC Forward Current <sup>[1]</sup>	20	mA
Peak Pulsing Current <sup>[2]</sup>	100	mA
Power Dissipation	92	mW
Reverse Voltage ( $I_R = 100 \mu\text{A}$ )	5	V
Maximum LED Junction Temperature	95	$^\circ\text{C}$
Operating Temperature Range	-30 to +85	$^\circ\text{C}$
Storage Temperature Range	-40 to +85	$^\circ\text{C}$
Soldering Temperature	See IR soldering profile (Figure 7)	

**Notes:**

1. Derate linearly as shown in Figure 4 for temperature above  $25^\circ\text{C}$ .
2. Pulse condition of 1/10 duty and 0.1 msec. width.

### Optical Characteristics at $T_A=25^\circ\text{C}$

Part No.	Color	Luminous Intensity <sup>[1]</sup> $I_v$ (mcd) @ 20 mA		Peak Wavelength $\lambda_{\text{peak}}$ (nm)	Dominant Wavelength $\lambda_d$ (nm)	Viewing Angle $2\theta_{1/2}$ (degrees) <sup>[2]</sup>
		Min.	Typ.	Typ.	Typ.	Typ.
HSMB-C190/C170/C150	SiC Blue	1.60	6.0	428	466	170
HSMB-C110	SiC Blue	1.60	6.5	428	466	130

**Notes:**

1. The luminous intensity,  $I_v$ , is measured at the peak of the spatial radiation pattern, which may not be aligned with the mechanical axis of the lamp package.
2.  $\theta_{1/2}$  is the off-axis angle where the luminous intensity is 1/2 the peak intensity.

### Electrical Characteristics at $T_A=25^\circ\text{C}$

Part No.	Forward Voltage $V_F$ (Volts) @ $I_F = 20 \text{ mA}$		Reverse Breakdown $V_R$ (Volts) @ $I_R = 100 \mu\text{A}$	Thermal Resistance $R_{\theta_{J-P}}$ ( $^\circ\text{C}/\text{W}$ )	Capacitance C (pF) @ $V_F = 0 \text{ V}$ , $f = 1 \text{ MHz}$
	Typ.	Max.	Min.	Typ.	Typ.
HSMB-C190/C170/C150	3.8	4.6	5	300	67
HSMB-C110	3.8	4.6	5	300	67

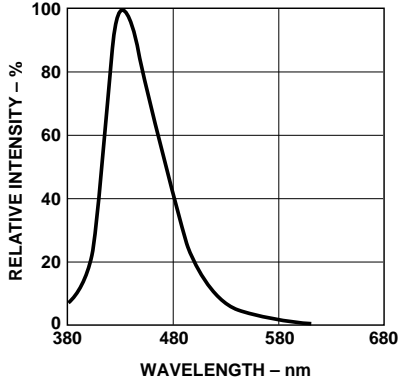

Figure 1. Relative Intensity vs. Wavelength.

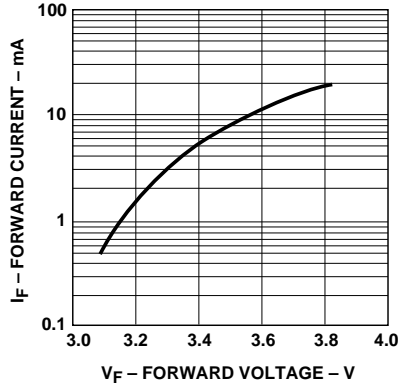

Figure 2. Forward Current vs. Forward Voltage.

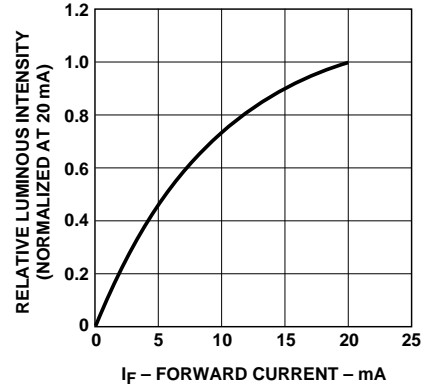

Figure 3. Relative Luminous Intensity vs. Forward Current.

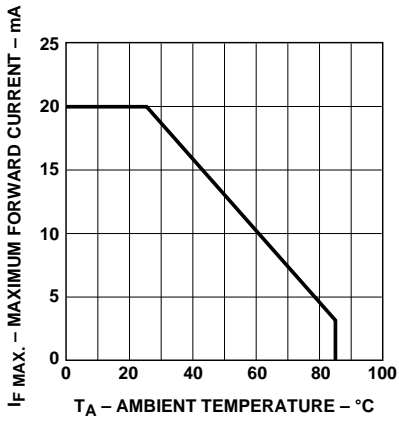

Figure 4. Maximum Forward Current vs. Ambient Temperature.

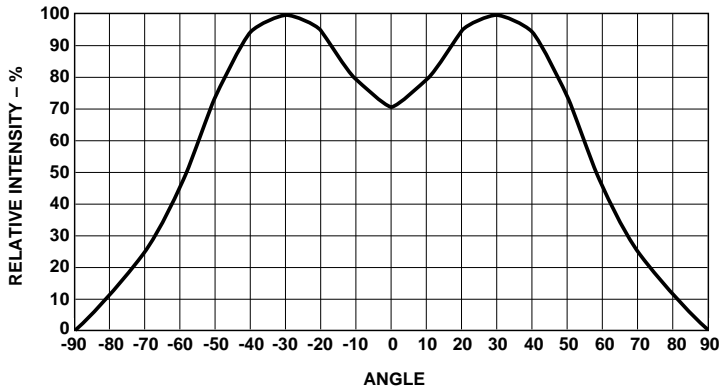
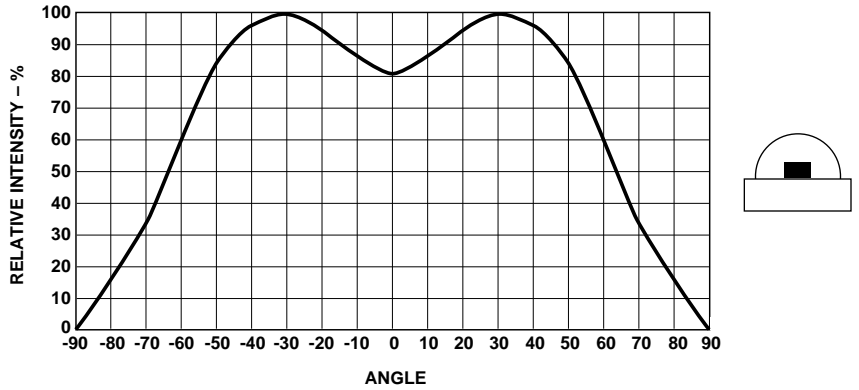

Figure 5. Relative Intensity vs. Angle for HSMB-C110.

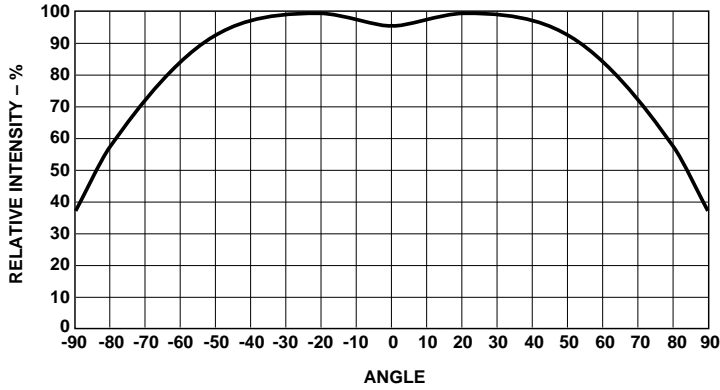

Figure 6. Relative Intensity vs. Angle for HSMB-C170, HSMB-C190, and HSMB-C150.

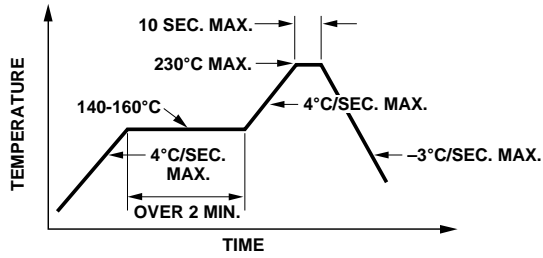

Figure 7. Recommended Reflow Soldering Profile.

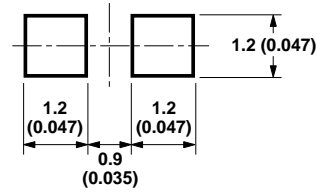

Figure 8. Recommended Soldering Pattern for HSMB-C170.

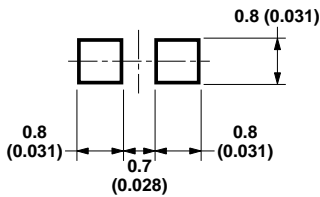

Figure 9. Recommended Soldering Pattern for HSMB-C190.

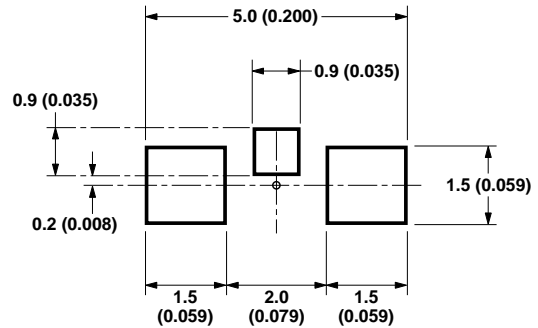
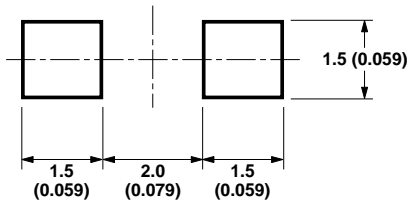

Figure 10. Recommended Soldering Pattern for HSMB-C110.

Note:

1. All dimensions in millimeters (inches).



**Figure 11. Recommended Soldering Pattern for HSMB-C150.**

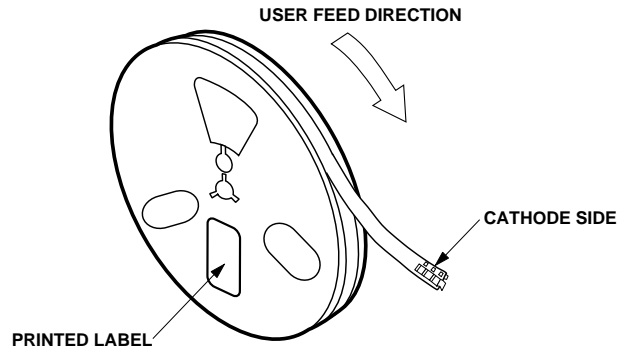

**Figure 12. Reeling Orientation.**

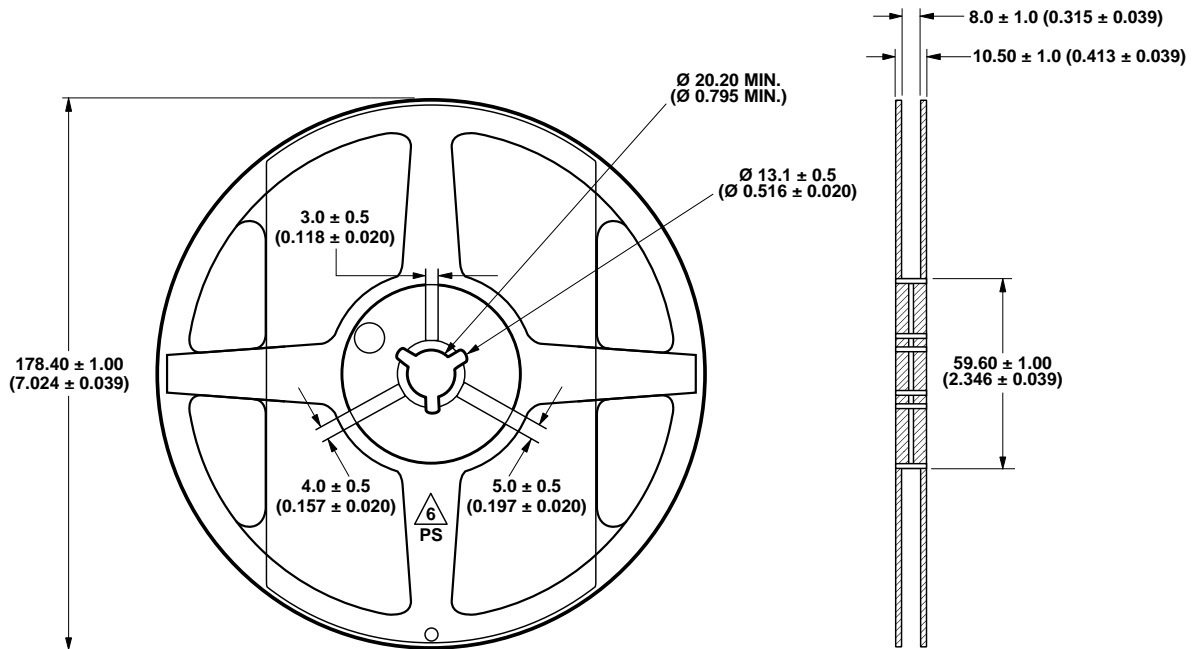

**Figure 13. Reel Dimensions.**

**Note:**

1. All dimensions in millimeters (inches).

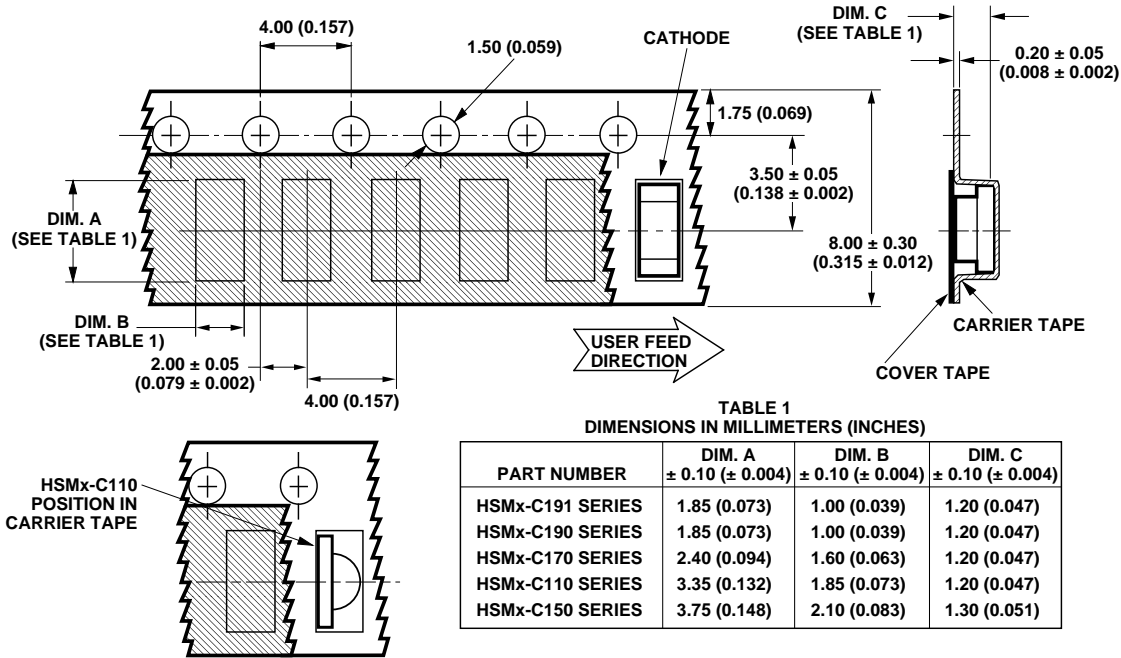

Figure 14. Tape Dimensions.

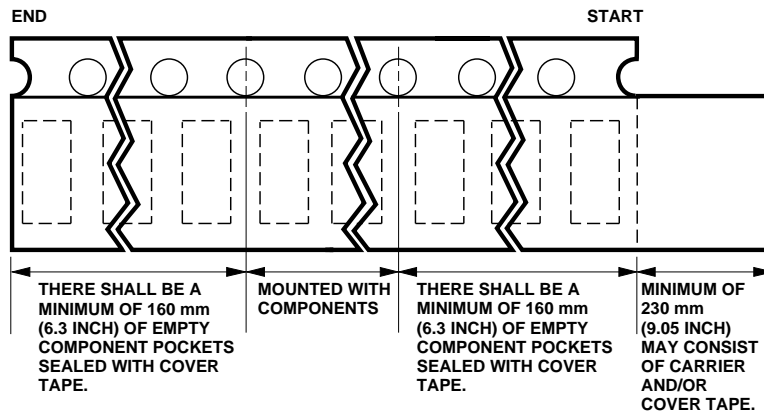

Figure 15. Tape Leader and Trailer Dimensions.

**Notes:**

1. All dimensions in millimeters (inches).
2. Tolerance is ± 0.1 mm (± 0.004 in.) unless otherwise specified.

## **Convective IR Reflow Soldering**

For more information on IR reflow soldering, refer to Application Note 1060, *Surface Mounting SMT LED Indicator Components*.

Storage Condition: 5 to 30° C @ 60% RH max.

Baking is required under the condition:

- a) the blue silica gel indicator becoming white/transparent color
- b) the pack has been opened for more than 1 week

Baking recommended condition: 60 +/- 5° C for 20 hours.